

**PHILIPS**

*NeoPix Easy*

Mini projector

**EN** User Manual  
**FR** Manuel utilisateur  
**DE** Bedienungsanleitung  
**ES** Manual del usuario  
**IT** Manuale d'uso



Register your product and get support at  
[www.philips.com/support](http://www.philips.com/support)

**PHILIPS**

*NeoPix Easy*

Mini projector

# User Manual



Register your product and get support at  
[www.philips.com/support](http://www.philips.com/support)

# Table of contents

<b>Introduction</b> .....	<b>3</b>	Set sleep timer.....	14
Dear customer .....	3	Set auto sleep.....	14
About this user manual.....	3	<b>7 Service</b> .....	<b>15</b>
What's in the box.....	3	Cleaning.....	15
<b>1 General safety information</b> .....	<b>4</b>	Update software .....	15
Setting up the product .....	4	Troubleshooting.....	16
Repairs .....	4	<b>8 Appendix</b> .....	<b>17</b>
Power supply .....	5	Technical data .....	17
<b>2 Overview</b> .....	<b>5</b>		
Top view.....	5		
Front view.....	6		
Side view.....	6		
Rear view.....	6		
Remote control.....	6		
Access home menu .....	7		
<b>3 Initial operation</b> .....	<b>7</b>		
Placing projector.....	7		
Changing screen size .....	8		
Connecting power supply .....	8		
Preparing the remote control.....	9		
Power on and setup .....	9		
<b>4 Connect to playback devices</b> .....	<b>10</b>		
Connecting to devices through HDMI.....	10		
Connecting to devices through AV.....	10		
Connecting to a computer through VGA.....	10		
Connecting to external speakers or headphones .....	11		
<b>5 Media playback</b> .....	<b>12</b>		
Movie playback.....	12		
Music playback .....	12		
Photo playback.....	13		
<b>6 Change settings</b> .....	<b>14</b>		
Picture settings.....	14		
Sound settings.....	14		
Language settings.....	14		
Restore default settings.....	14		
Rotate/flip projection screen.....	14		

# Introduction

## Dear customer

Thank you for purchasing this projector.

We hope you enjoy this product and the many functions it offers!

## About this user manual

The quick start guide supplied with this product allows you to start using this product quickly and easily. Detailed descriptions can be found in the following sections of this user manual.

Read the entire user manual carefully. Follow all safety instructions in order to ensure proper operation of this product (see **General safety information, page 4**). The manufacturer accepts no liability if these instructions are not followed.

## Symbols used

### Notice

#### Troubleshooting

This symbol indicates tips that will help you in using this product more effectively and easily.

### DANGER!



#### Danger of personal injury!

This symbol gives warning of danger of personal injury. Physical injury or damage can result from improper handling.

### CAUTION!



#### Damage to the product or loss of data!

This symbol gives warning of damage to the product and possible loss of data. Damage can result from improper handling.

## What's in the box

- ① NeoPix Easy projector (NPX440)
- ② Remote control with 2 AAA batteries
- ③ A/C power adapter
- ④ Power plugs (EU, UK, US)
- ⑤ Quick Start Guide
- ⑥ Lens cover

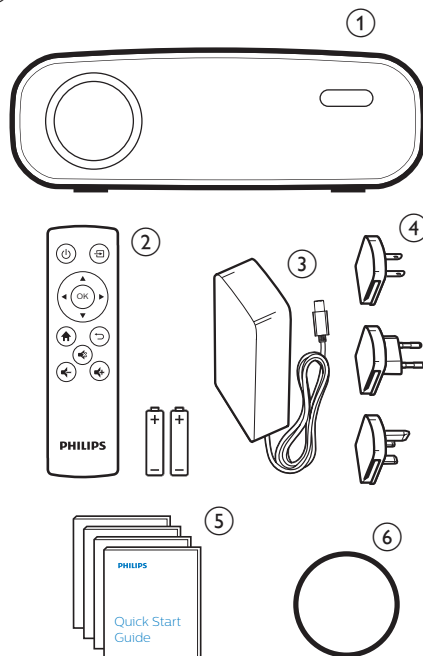

# 1 General safety information

Take note of all warning and safety notes indicated. Do not make any changes or settings that are not described in this user manual. Incorrect operation, and improper handling can lead to physical injury, damage to the product or loss of data.

## Setting up the product

This product is for indoor use only. Place the product securely on a stable, flat surface. To help avoid possible injuries to persons or damage to the product itself, position all cables in such a way that no one will trip over them.

Do not operate the product in damp rooms. Never touch the mains cable or the mains connection with wet hands.

The product must have sufficient ventilation and must not be covered. Do not put the product in closed cabinets, boxes, or other enclosures when in use.

Protect the product from direct sunlight, heat, intense temperature fluctuations and moisture. Do not place the product in the vicinity of heaters or air conditioners. Observe the information on temperature listed in the technical data (see **Technical data, page 17**).

Prolonged operation of the product causes the surface to become hot. In case of overheating, the product automatically switches to standby mode.

Do not allow liquids to leak into the product. Turn off the product and disconnect it from the mains supply if liquids or foreign substances leaked into the product. Have the product inspected by an authorised service centre.

Always handle the product with care. Avoid touching the lens. Never place heavy or sharp objects on the product or on the power cable.

If the product gets too hot or emits smoke, shut it down immediately and unplug the power cable. Have your product checked by an authorised service centre. Keep the product away from open flames (e.g. candles).

### DANGER!



**Risk of explosion with incorrect type of batteries!**

There is a risk of explosion if the wrong battery type is used.

Do not expose the batteries (battery pack or embedded batteries) to excessive heat such as sunshine, or open fire.

Under the following conditions, a layer of moisture can appear inside the product which can lead to malfunctions:

- if the product is moved from a cold to a warm area;
- after a cold room is heated;
- when the product is placed in a damp room.

Proceed as follows to avoid any moisture buildup:

- 1 Seal the product in a plastic bag before moving it to another room, in order for it to adapt to room conditions.
- 2 Wait one to two hours before you take the product out of the plastic bag.

The product should not be used in a very dusty environment. Dust particles and other foreign objects may damage the product.

Do not expose the product to extreme vibrations. This may damage the internal components.

Do not allow children to handle the product without supervision. The packing materials should be kept out of the hands of children.

For your own safety, do not use the product during thunderstorms with lightning.

## Repairs

Do not repair the product yourself. Improper maintenance can result in injuries or damage to the product. The product must be repaired by an authorised service centre.

Please find the details of authorised service centres on the warranty card supplied with this product.

Do not remove the type label from this product, as this will void the warranty.

## Power supply

Use only a power adapter which is certified for this product (see **Technical data, page 17**). Check whether the mains voltage of the power supply matches the mains voltage available at the setup location. This product complies with the voltage type specified on the product.

The power outlet shall be installed near the product and shall be easily accessible.

### CAUTION!



Always use the  button to turn the projector off.

Turn off the product and unplug from the power outlet before cleaning the surface (see **Cleaning, page 15**). Use a soft, lint-free cloth. Never use liquid, gaseous or easily flammable cleaners (sprays, abrasives, polishes, alcohol). Do not allow any moisture to reach the interior of the product.

### DANGER!







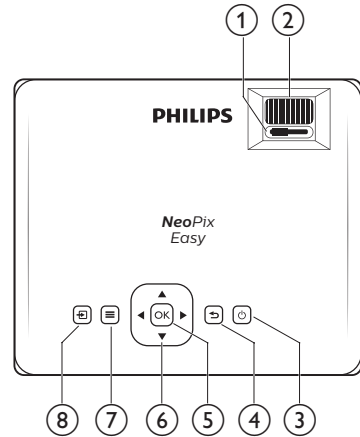

#### Risk of eye irritation!

This product is equipped with a high power LED (Light Emitting Diode), which emits very bright light. Do not look directly into the projector lens during operation. This could cause eye irritation or damage.

## 2 Overview

### Top view



- ① **Keystone adjustment knob**  
Adjust distorted images to a rectangular or square shape.
- ② **Focus adjustment knob**  
Adjust image sharpness.
- ③ 
  - Switch the projector on or to standby.
  - When the projector is switched on, the LED turns green. When the projector is in standby, the LED turns red.
- ④   
Return to a previous menu screen.
- ⑤ **OK**  
Confirm a selection or entry.
- ⑥ **Navigation buttons**
  - Navigate menu options.
  - Press  to change a selection.
- ⑦   
Access the settings menu.
- ⑧ 
  - Access the home menu.
  - Access input source list.

## Front view

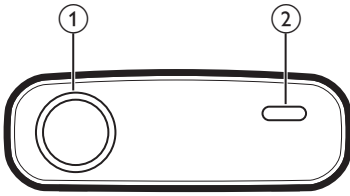

- ① Projection lens
- ② Front IR sensor

## Side view

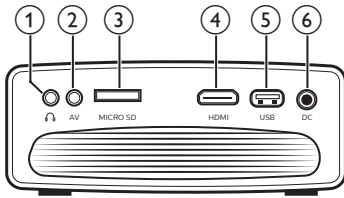

- ①  3.5 mm audio output; connect to external speakers or headphones.
- ② **AV**  
3.5 mm audio/video input; connect to the analogue audio jacks and/or composite video jack on a playback device.
- ③ **Micro SD card slot**  
Connect to a Micro SD card for media play.
- ④ **HDMI**  
Connect to the HDMI output on a playback device.
- ⑤ **USB port**  
Connect to a USB storage device for media play.
- ⑥ **DC**  
Connect to the power supply.



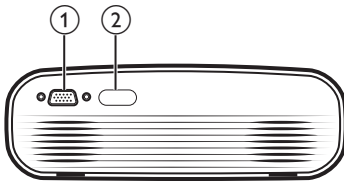



## Rear view

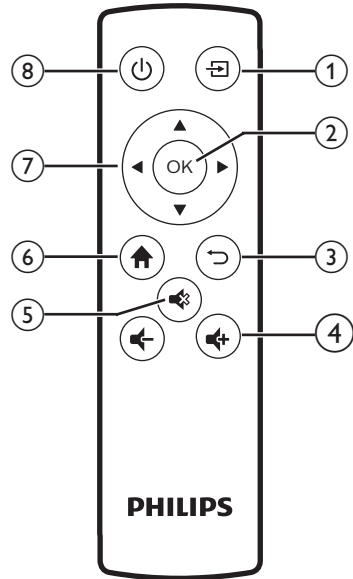

- ① **VGA port**  
Connect to the VGA port on a computer.
- ② **Rear IR sensor**

## Remote control



- ① 
  - Access the home menu.
  - Access input source list.
- ② **OK**  
Confirm a selection or entry.
- ③    
Return to a previous menu screen.
- ④    
Increase or decrease volume.
- ⑤    
Mute or restore volume.
- ⑥    
Access the home menu.
- ⑦ **Navigation buttons**
  - Navigate menu options.
  - Press ◀▶ to change a selection.
- ⑧ 
  - Switch the projector on or to standby.
  - When the projector is switched on, the LED turns green. When the projector is in standby, the LED turns red.

## Access home menu

The home menu provides easy access to media player, setup and other useful features in the projector.

- 1 Press **↑**. The home menu is displayed.
- 2 Press the **Navigation buttons** and **OK** to select the following.

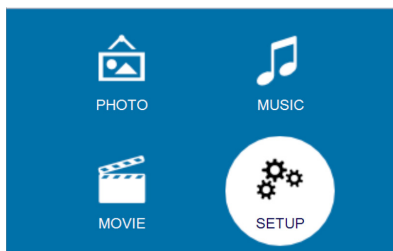

- **PHOTO**: Activate photo media player to access and play photo files.
- **MUSIC**: Activate music media player to access and play music files.
- **MOVIE**: Activate movie media player to access and play movie files.
- **SETUP**: Access menus to change picture, sound and other settings

# 3 Initial operation

## Placing projector

You can install the projector in four different configuration. Follow the guidelines below for different projector placement.

### Notice

**i** For overhead mounting on ceiling, purchase a projector mount recommended by an installation professional and follow the instructions that come with the mount.

Before mounting on the ceiling, make sure the ceiling can support the weight of the projector and mounting kit.

For ceiling installation, this product must be securely attached to the ceiling in accordance with the installation instructions. An improper ceiling installation may result in accident, injury or damage.

### Front table

- 1 Place the projector on a table in front of the projection screen. This is the most common way to position the projector for quick setup and portability.

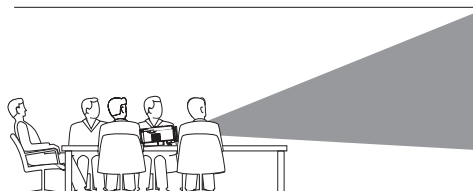

- 2 To adjust projection to the correct position, press **↑**, and go to **SETUP - Panel Flip Rotate**.

### Front ceiling

- 1 Mount the projector on the ceiling with upside up in front of the projection screen. A projector mount is required to mount the projector on ceiling.



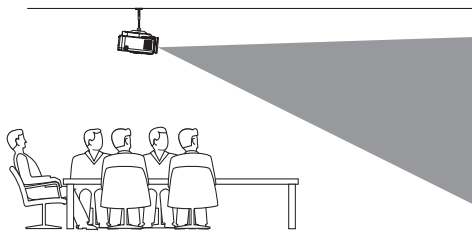

- 2 To adjust projection to the correct position, press **▲**, and go to *SETUP - Panel Flip Rotate*.

### Rear table

- 1 Place the projector on a table behind the projection screen. A special rear projection screen is required.

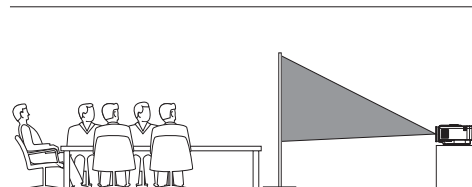

- 2 To adjust projection to the correct position, press **▲**, and go to *SETUP - Panel Flip Rotate*.

### Rear ceiling

- 1 Mount the projector on ceiling with upside up behind the projection screen. To mount the projector on ceiling behind the screen, a projector mount and a special rear projection screen is required.

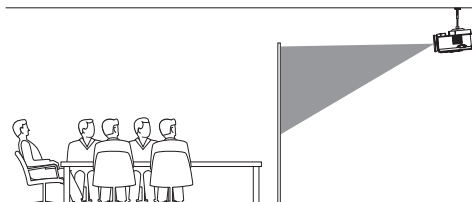

- 2 To adjust projection to the correct position, press **▲**, and go to *SETUP - Panel Flip Rotate*.

## Changing screen size

The projection screen size (or size of images) is determined by the distance between the lens of the projector and the projection surface.

- The projection image size is up to 80" (200 cm).
- The projection distance is 80 cm - 200 cm / 24" - 60".

## Connecting power supply

### CAUTION!



Always use the **⏻** button to turn the projector on and off.

- 1 Fix an appropriate plug (EU, UK, US) onto the round base of the power adapter by aligning the pins and holes.
  - To detach the plug from the power adapter, hold down the tab at the edge of the round base, and simultaneously turn and unlock the plug from the round base of the power adapter.

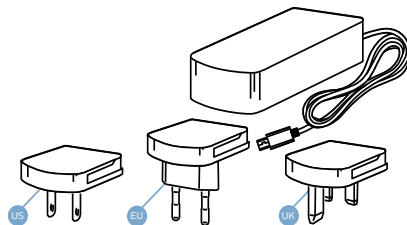

- 2 Connect the included power adapter to the **DC** socket on the projector, and then to the wall outlet.
  - The LED on the projector turns red.

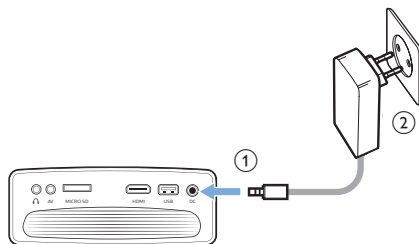

# Preparing the remote control

## CAUTION!



The improper use of batteries can lead to overheating, explosion, risk of fire and injury. Leaking batteries can possibly damage the remote control.

Never expose the remote control to direct sunlight.

Avoid deforming, dismantling or charging the batteries.

Avoid exposure to open fire and water.

Replace empty batteries immediately.

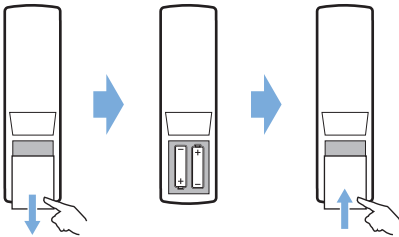

Remove the batteries from the remote control if not in use for long periods of time.

- 1 Open the battery compartment.
- 2 Insert the supplied batteries (type AAA) with correct polarity (+/-) indicated.
- 3 Close the battery compartment.



- When using the remote control, point the remote control at the IR sensor on the projector, and make sure there is no obstacle between the remote control and the IR sensor.

## Power on and setup

- 1 Press  to turn on the projector. The LED on the projector turns from red to green.
  - To turn off the projector, press  again. The LED on the projector turns from green to red.
  - The distance between the projector and the screen determines the actual size of the image.

- 2 To adjust the screen height when placing the projector on the table, turn the angle adjustment knob located on the bottom of the projector.

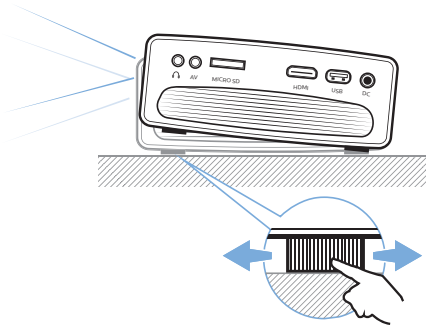

- 3 To adjust image focus, turn the focus knob on the top of the projector.

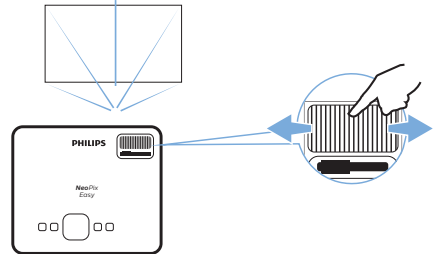

- 4 To correct keystone or distorted images to be rectangular or square, turn the keystone knob on the top of the projector.

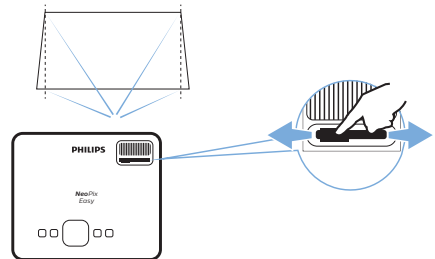

# 4 Connect to playback devices

## Notice



Make sure all devices are disconnected from the power outlet before establishing or changing any connections.

## Connecting to devices through HDMI

Connect a playback device (e.g. a Blu-ray player, gaming console, camcorder, digital camera or PC) to the projector through HDMI connection. With this connection, images are shown on the projection screen, and audio is played on the projector.

- 1 Using an HDMI cable, connect the **HDMI** connector on the projector to the HDMI output on the playback device.

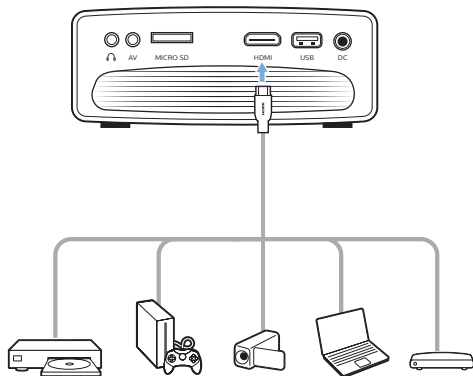

- 2 Press to display the input source list, and then select **HDMI**.

## Connecting to devices through AV

Connect a playback device (e.g. a DVD player, gaming console, camcorder or digital camera) to the projector through AV connection. With this connection, images are shown on the projection screen, and audio is played on the projector.

- 1 Using a RCA cable with 3.5 mm plug, connect the **AV** connector (3.5 mm) on the projector to the analogue audio output

jacks (red and white) and/or composite video output jack on a playback device.

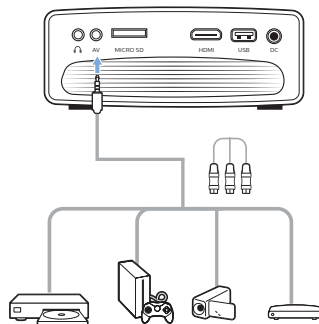

- 2 Press to display the input source list, and then select **AV**.

## Connecting to a computer through VGA

Connect a computer (e.g. a desktop or laptop) to the projector. With this connection, images are shown on the projection screen.

## Notice



Many laptops do not activate the external video output automatically when you connect a second display such as a projector. Check your laptop user manual to find out how to activate the external video output.

- 1 Using a VGA cable, connect the **VGA** connector on the projector to the VGA output on a computer.

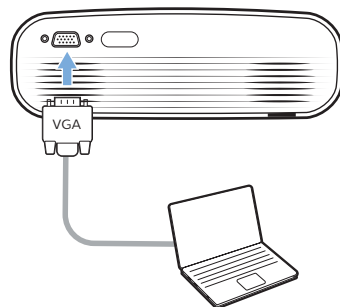

- 2 On your computer, adjust the screen resolution of the computer to the correct setting and switch the VGA signal to an external monitor. The following resolutions are supported:

	Resolution	Image refresh rate
VGA	640 x 480	60 Hz
SVGA	800 x 600	60 Hz
XGA	1024 x 768	60 Hz
WXGA	1280 x 768	60 Hz
HD	1280 x 720	60 Hz
FULL HD	1920 x 1080	60 Hz

- 3 Press  to display the input source list, and then select VGA.

## Connecting to external speakers or headphones

Connect external speakers or headphones to the projector. With this connection, audio from the projector is played through the external speakers or headphones.



### DANGER!



#### Danger of hearing damage!

Before connecting the headphones, turn down the volume on the projector.

Do not use the projector over a longer time at high volume – especially when using headphones. This could lead to hearing damage.

- 1 Using a 3.5 mm audio cable, connect the  connector on the projector to the analogue audio input (3.5 mm jack, or red and white jacks) on the external speakers. Or connect the  connector on the projector to headphones.
  - The speakers of the projector are deactivated automatically when the external speakers or headphones are connected to the projector.

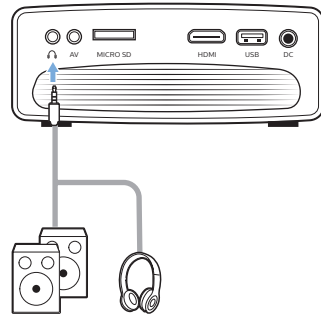

- 2 When connecting to the headphones, use the volume control on the remote control to adjust the volume to a comfortable level.

# 5 Media playback

This section helps you use the projector to play media from a wide range of sources.

## Notice

-  The projector supports a USB storage device that is formatted for FAT16 or FAT32 file systems.

## Movie playback

### Supported file formats

The following file formats are supported:

.dat/.mpg/.mpeg/.ts/.trp/.tp/.vob/.mp4/.mkv/.avi/.flv/.3gp

- 1 Connect a USB storage device to the **USB** port on the projector.
  - Or connect a Micro SD card to the **MICRO SD** slot on the projector.

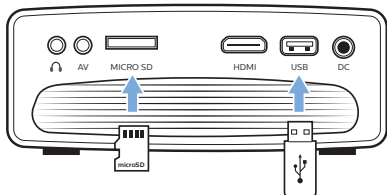

- 2 Press  to display the home menu on the projection screen.

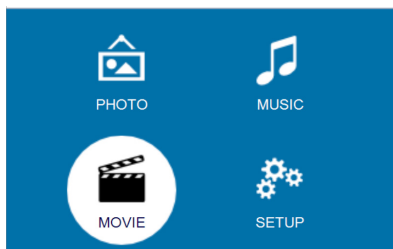

- 3 Press the **Navigation buttons** and **OK** to select a following media player.
  - *MUSIC*: access and play audio files only.
  - *MOVIE*: access and play video files only.
  - *PHOTO*: access and play photo files only.
- 4 Select *MOVIE* to activate video media player and access video files.
  - If video media player is selected, only the playable video files can be displayed.

- 5 Select a video file and press **OK** to play video.
- 6 During video playback, press **OK**. The playback control icons are displayed at the bottom of the projection screen. You can access the following playback functions.
  - Pause or resume play
  - Fast search backward or forward
  - Select a previous or next video file
  - Stop play
  - Select a play mode: repeat one/repeat all
  - Mark two points to repeat play
  - Access playlist
  - Access current file information
  - Slow forward
  - Step forward
  - Set aspect ratio (auto, 16:9 and 4:3)
- 7 Select a control function and press **OK** to trigger the control. To exit a particular mode, press .

## Music playback

### Supported file formats

The following file formats are supported: .mp3/.aac/.ogg/.flac

- 1 Repeat step 1 to 2 in 'Movie playback', and the home menu is displayed.

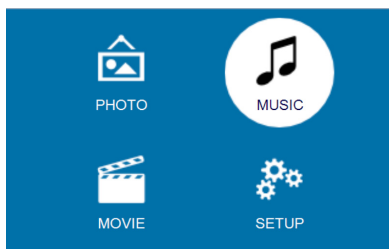

- 2 Press the **Navigation buttons** and **OK** to select a following media player.
  - *MUSIC*: access and play audio files only.
  - *MOVIE*: access and play video files only.
  - *PHOTO*: access and play photo files only.
- 3 Select *MUSIC* to activate music media player and access music files.
  - If music media player is selected, only the playable music files can be displayed.
- 4 Select a music file and press **OK** to play music.

- 5 The playback control icons are displayed at the bottom of the projection screen. You can access the following playback functions.
  - Pause or resume play
  - Fast search backward or forward
  - Select a previous or next music file
  - Stop play
  - Select a play mode: repeat one/repeat all
  - Mark two points to repeat play
  - Mute or restore volume
  - Access playlist
  - Access current file information
- 6 Select a control function and press **OK** to trigger the control. To exit a particular mode, press ↩.

- Pause or resume play
- Select a previous or next photo file
- Stop play
- Select a play mode: repeat one/repeat all
- Play music
- Access playlist
- Access current file information
- Rotate a photo
- Zoom in or out a photo
- Pan a zoomed picture up, down, left or right

- 6 Select a control function and press **OK** to trigger the control. To exit a particular mode, press ↩.

## Photo playback

### Supported file formats

The following file formats are supported: .jpeg/.bmp/.png/.gif

- 1 Repeat step 1 to 2 in 'Movie playback', and the home menu is displayed.

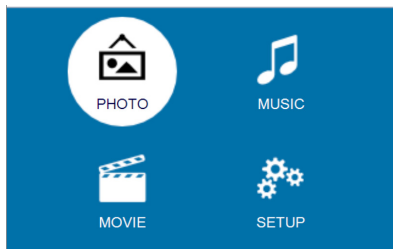

- 2 Press the **Navigation buttons** and **OK** to select a following media player.
  - *MUSIC*: access and play audio files only.
  - *MOVIE*: access and play video files only.
  - *PHOTO*: access and play photo files only.
- 3 Select *PHOTO* to activate photo media player and access photo files.
  - If photo media player is selected, only the playable photo files can be displayed.
- 4 Select a photo file and press **OK** to start slide show.
- 5 The playback control icons are displayed at the bottom of the projection screen. You can access the following playback functions.

# 6 Change settings

This section helps you change the settings of the projector.

## Picture settings

- 1 Press **▲**.
- 2 Select **SETUP**, and then press **OK** to access the setting options.
- 3 Select a picture option, and then press **◀▶** to change:
  - **Picture Mode**: Select pre-defined color settings for picture or video display. Select **User** to customize the following settings:
    - **Contrast**: Set color contrast.
    - **Brightness**: Set color brightness.
    - **Color**: Set color saturation.
    - **Sharpness**: Set image sharpness.
  - **Color Temperature**: Set different color temperature.
  - **Aspect Ratio**: Set a screen ratio.
  - **Noise Reduction**: Set a noise reduction level.

## Sound settings

- 1 Press **▲**.
- 2 Select **SETUP**, and then press **OK** to access the setting options.
- 3 Select a sound option, and then press **◀▶** to change:
  - **Sound Mode**: Select pre-defined sound settings for your video or music. Select **User** to customize the following settings:
    - **Treble**: Set a treble level.
    - **Bass**: Set a bass level.
  - **Balance**: Adjust balance levels to experience the original sound of your movie and music.
  - **Auto Volume**: Set auto volume on to reduce sudden changes in volume.
  - **Surround Sound**: Turn surround on or off.

## Language settings

- 1 Press **▲**.
- 2 Select **SETUP**, and then press **OK** to access the setting options.
- 3 Select **OSD Language**, and then press **◀▶** on the remote control to select your desired language for on-screen menu.

## Restore default settings

- 1 Press **▲**.
- 2 Select **SETUP**, and then press **OK** to access the setting options.
- 3 Select **Restore Factory Default**, and then press **OK**.
- 4 Follow the on-screen instructions to start or cancel resetting.

## Rotate/flip projection screen

- 1 Press **▲**.
- 2 Select **SETUP**, and then press **OK** to access the setting options.
- 3 Select **Panel Flip Rotate**, and then press **◀▶** to rotate or flip the projection screen.

## Set sleep timer

Set a period of time after which the projector turns off automatically.

- 1 Press **▲**.
- 2 Select **SETUP**, and then press **OK** to access the setting options.
- 3 Select **Sleep Timer**, and then press **◀▶** to select a period of time (in minute).

## Set auto sleep

Set a time length so that the projector turns off automatically after a period of time of inactivity.

- 1 Press **▲**.
- 2 Select **SETUP**, and then press **OK** to access the setting options.
- 3 Select **Auto Sleep**, and then press **◀▶** to select a period of time (in hour).

# 7 Service

## Cleaning

### DANGER!



#### Instructions for cleaning!

Use a soft, lint-free cloth. Never use liquid or easily flammable cleansers (sprays, abrasives, polishes, alcohol, etc.). Do not allow any moisture to reach the interior of the projector. Do not spray the projector with any cleaning fluids.

Wipe over the surfaces gently. Be careful that you do not scratch the surfaces.

- Make sure the unzipped file name is “GXY\_MELODY.bin” or “GXY\_MELODY\_64.bin”.

- 3 Turn off the projector, then connect the USB flash drive to the projector.
- 4 Turn on the projector, then the upgrade starts automatically. The LED on the projector blinks during upgrade.
- 5 Wait about 15 seconds. The upgrade completes and the projector turns off automatically.
- 6 Disconnect the USB from the projector, then turn on the projector.

## Cleaning the lens

Use a soft brush or lens cleaning paper for cleaning the lens of the projector.

### DANGER!



#### Do not use any liquid cleaning agents!

Do not use any liquid cleaning agents for cleaning the lens, to avoid damaging the coating film on the lens.

## Update software

The latest software of the projector can be found on [www.philips.com/support](http://www.philips.com/support) for you to get the best features and support from the projector.

Before you update the software of the projector, check the current software version:

- Press , and then select *SETUP - Info*.

### CAUTION!



Do not turn off the projector or remove the USB flash drive during the update.

## Update SW through USB



- 1 Check the latest software version on [www.philips.com/support](http://www.philips.com/support). Find your product (model number: NPX440), and locate ‘Software and drivers’.
- 2 Download the software into the USB flash drive. Unzip the downloaded software file and save it in the root directory of the USB flash drive.



# Troubleshooting

## Power cycling

If a problem occurs that cannot be corrected with the instructions in this user manual, follow the steps given here.

- 1 Turn the projector off by pressing .
- 2 Wait at least ten seconds.
- 3 Turn the projector on by pressing  once.
- 4 If the problem persists, please contact our technical service centre or your dealer.

Problems	Solutions
The projector cannot be turned on.	<ul style="list-style-type: none"><li>• Disconnect and reconnect the power cable, and try to turn the projector on again.</li></ul>
The projector cannot be turned off.	<ul style="list-style-type: none"><li>• Press and hold  longer than ten seconds. If this does not work, disconnect the power cable.</li></ul>
No image from the external HDMI device.	<ul style="list-style-type: none"><li>• Disconnect the HDMI cable or switch off the HDMI device.</li><li>• Wait <b>three</b> seconds.</li><li>• Reconnect the HDMI cable or switch on the HDMI device again.</li></ul>
No sound from the external connected device.	<ul style="list-style-type: none"><li>• Check the cables to the external device.</li><li>• Check that the sound is activated on the external device.</li><li>• Only the original cables from the device manufacturer may function.</li></ul>
No sound from external HDMI output device.	<ul style="list-style-type: none"><li>• On the HDMI output device, set the audio setting to Multichannel (Raw data) &amp; Stereo (PCM).</li></ul>
No sound when you connect your computer via HDMI cable.	<ul style="list-style-type: none"><li>• Check that the sound is activated on the computer.</li></ul>
Only the home menu appears and not the image from the external device.	<ul style="list-style-type: none"><li>• Check if the cables are connected to the correct sockets.</li><li>• Check that the external device is turned on.</li><li>• Check if the video output of the external device is turned on.</li></ul>
Only the home menu appears and not the image from the connected computer.	<ul style="list-style-type: none"><li>• Check that the VGA output of the computer is turned on.</li><li>• Check if the resolution of the computer is set to 1920*1080 (for VGA connection) or 1080P (for HDMI connection).</li></ul>
The projector turns itself off.	<ul style="list-style-type: none"><li>• When the projector is running for a long period of time, the surface becomes hot.</li><li>• Check that the power cable is connected correctly.</li></ul>
The projector cannot read the USB stick.	<ul style="list-style-type: none"><li>• The projector does not support the exFAT file system.</li><li>• Format the USB stick in FAT format, then use it.</li></ul>
The projector does not react to remote control commands.	<ul style="list-style-type: none"><li>• Check the batteries of the remote control.</li></ul>
The temperature of the projector's surface is warm.	<ul style="list-style-type: none"><li>• For this projector it is normal to generate moderate heat during operation.</li></ul>
What to do if the projector does not work when connecting to a notebook PC?	<ul style="list-style-type: none"><li>• Check that the HDMI cable is plugged in correctly.</li><li>• Make sure that the notebook PC has been switched to projector display.</li></ul>

# 8 Appendix

## Technical data

### Technology/optical

Display technology .....	LCD
Light source .....	LED
Resolution .....	800 × 480 pixel
LED lifetime .....	up to 20,000 h
Contrast ratio .....	3000:1
Aspect ratio .....	16:9
Throw ratio .....	1,4:1
Brightness .....	up to 2600 LED lumens
Projection image size (diagonal) .....	up to 80" (200 cm)
Projection distance .....	80 cm - 200 cm / 24" - 60"
Keystone correction .....	manual
Projection modes .....	front, rear, ..... front ceiling, rear ceiling
Focus adjustment.....	manual
Frame rate.....	30 Hz
Image lag time.....	< 5 ms
Image response time.....	< 5 ms

### Sound

Built-in speakers.....	2
Output power.....	2 x 2 W

### Connection

Connectivity.....	HDMI, CVBS, VGA, USB (2.0), ..... Micro SD card slot, ..... headphone out (3.5 mm)
-------------------	--

### Power source

Power consumption .....	operating: 42 W ..... Standby: 0.3 W
Power supply .....	power adapter ..... Input: 100-240V~, 50/60Hz, 1.0 A (max) ..... Output: DC 12 V, 3.5 A

### Product details

Dimensions (W × D × H) .....	207 x 150 x 84.5 mm
Weight .....	0.86 kg
Operating temperature.....	< 40 °C
Storage temperature .....	< 60 °C

### Package content

NeoPix Easy projector, remote control with 2 AAA batteries, AC adapter, power plugs (EU, UK, US), lens cover, Quick Start Guide



The CE marking certifies, that the product meets the main requirements of the European Parliament and Council directives EMC directive 2014/30/EU, LVD directive 2014/35/EU, EN 55032:2015, EN 55035:2017, EN 61000-3-2:2014, EN 61000-3-3:2013, EN 60065:2014+A11:2017 on information technology equipment, regarding safety and health of users and regarding electromagnetic interference.

The Declaration of Compliance can be consulted on the site [www.philips.com/projection](http://www.philips.com/projection).

Preservation of the environment as part of a sustainable development plan is an essential concern of Screeneo Innovation SA. The desire of Screeneo Innovation SA is to operate systems respecting the environment and consequently it has decided to integrate environmental performances in the life cycle of these products, from manufacturing to commissioning use and elimination.



#### Federal Communications Commission (FCC)

**Statement:** You are cautioned that changes or modifications not expressly approved by the party responsible for compliance could void the user's authority to operate the device.

This device has been tested and found to comply with the limits for a Class B digital device, pursuant to part 15 of the FCC rules. These limits are designed to provide reasonable protection against harmful interference in a residential installation. This device generates, uses and can radiate radio frequency energy and, if not installed and used in accordance with the instructions, may cause harmful interference to radio communications.

However, there is no guarantee that interference will not occur in a particular installation. If this device does cause harmful interference to radio or television reception, which can be determined by turning the device off and on, the user is encouraged to try to correct the interference by one or more of the following measures:

- Adjust or relocate the receiving antenna.
- Increase the separation between the device and receiver.
- Connect the device into an outlet on a circuit different from that to which the receiver is connected.
- Consult the dealer or an experienced radio/TV technician for help.

This device complies with Part 15 of the FCC Rules. Operation is subject to the following two conditions:

- 1 this device may not cause harmful interference;
- 2 this device must accept any interference received, including interference that may cause undesired operation.

#### FCC RF Radiation Exposure Statement:

This transmitter must not be in co-location or operating in conjunction with any other antenna or transmitter. This device complies with FCC RF radiation exposure limits set forth for an uncontrolled environment.

This device should be installed and operated with a minimum distance of 20 centimetres between the device and your body.

FCC ID: 2ASRT-NPX440

#### Canada Regulatory Compliance

This device complies with Industry Canada CAN ICES-3 (B)/NMB-3(B)

**RSS-Gen & RSS-247 statement:** This device complies with Industry Canada RSS standard(s). Operation is subject to the following two conditions:

- 1 This device may not cause interference, and
- 2 This device must accept any interference, including interference that may cause undesired operation of the device.

**RF Radiation Exposure statement:** The device meets the exemption from the routine evaluation limits in section 2.5 of RSS102 and users can obtain Canadian information on RF exposure and compliance.

This device should be installed and operated with a minimum distance of 7.8 inches (20 centimetres) between the device and your body.



**Packaging:** The presence of the logo (green dot) means that a contribution is paid to an approved national organisation to improve package recovery and recycling infrastructures. Please respect the sorting rules set up locally for this kind of waste.

**Batteries:** If your product contains batteries, they must be disposed of at an appropriate collection point.



**Product:** The crossed-out waste bin symbol on the product means that the product belongs to the family of electrical and electronic equipment. In this respect, the European regulations ask you to dispose of it selectively:

- At sales points in the event of the purchase of similar equipment.
- At the collection points made available to you locally (drop-off centre, selective collection, etc.).

In this way you can participate in the reuse and upgrading of Electrical and Electronic Equipment Waste, which can have an effect on the environment and human health.

The paper and cardboard packaging used can be disposed of as recyclable paper. Have the plastic wrapping recycled or dispose of it in the non-recyclable waste, depending on the requirements in your country.

**Trademarks:** The mentioned references in this manual are trademarks of the respective companies. The lack of the trademarks <sup>®</sup> and <sup>™</sup> does not justify the assumption that these dedicated terminologies are free trademarks. Other product names used herein are for identification purposes only and may be trademarks of their respective owners. Screeneo Innovation SA disclaims any and all rights in those marks.

Neither Screeneo Innovation SA nor its affiliates shall be liable to the purchaser of this product or third parties for damages, losses, costs, or expenses incurred by the purchaser or third parties as a result of accident, misuse, or abuse of this product or unauthorised modifications, repairs, or alterations to this product, or failure to strictly comply with Screeneo Innovation SA operating and maintenance instructions.

Screeneo Innovation SA shall not be liable for any damages or problems arising from the use of any options or any consumable materials other than those designated as original Screeneo Innovation SA/PHILIPS products or Screeneo Innovation SA/PHILIPS approved products.

Screeneo Innovation SA shall not be held liable for any damage resulting from electromagnetic interference that occurs from the use of any interface cables other than those designated as Screeneo Innovation SA/PHILIPS products.

All rights reserved. No part of this publication may be reproduced, stored in a retrieval system or transmitted in any form or by any means, electronic, mechanical, photocopying, recording, or otherwise, without the prior written permission of Screeneo Innovation SA. The information contained herein is designed only for use with this product. Screeneo Innovation SA is not responsible for any use of this information as applied to other devices.

This user manual is a document that does not represent a contract.

Errors, printing errors and changes are reserved. Copyright © 2019 Screeneo Innovation SA.



PHILIPS and the PHILIPS' Shield Emblem are registered trademarks of Koninklijke Philips N.V. used under license.

This product was brought to the market by Screeeno Innovation SA., further referred to in this document as Screeeno Innovation SA., and is the manufacturer of the product.

2019 © Screeeno Innovation SA.

All rights reserved.

**Headquarters:**

Screeeno Innovation SA.

Route de Lully 5C

1131 - Tolochenaz – Switzerland

[www.philips.com/welcome](http://www.philips.com/welcome)

**NeoPix Easy**

**EN**