

## 4. Installation 2/3

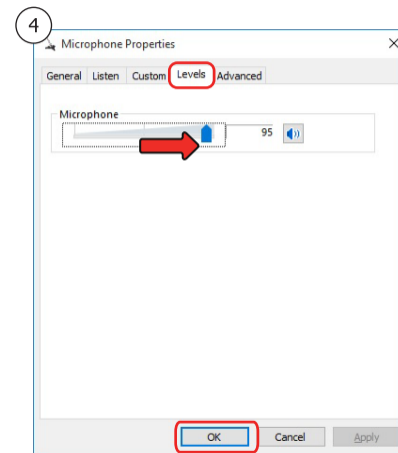

## 5. Installation 3/3

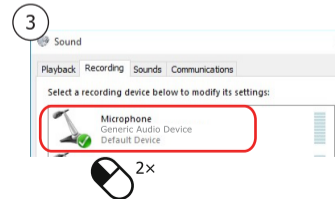
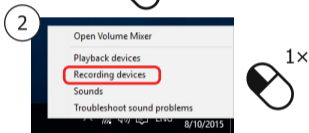
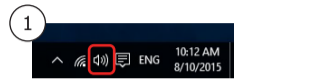
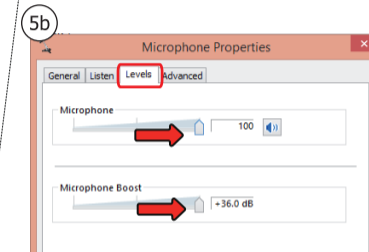
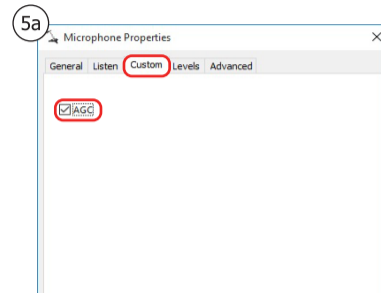

## FAQ

### Frequently Asked Questions

<http://www.trust.com/11916/faq>

**Trust**

## CHAT HEADSET

for laptop, phone  
and tablet

PRIMO



Quick Installation Guide

# 1. Headset

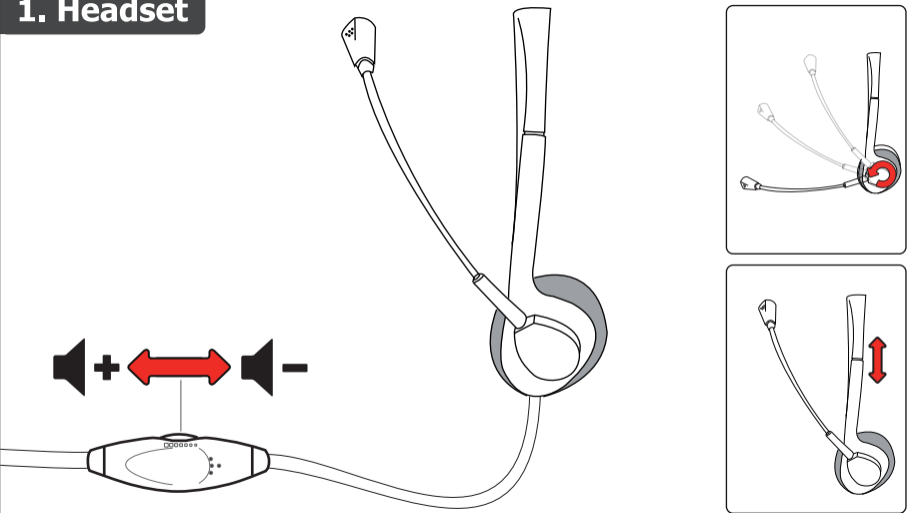

# 2. Setup

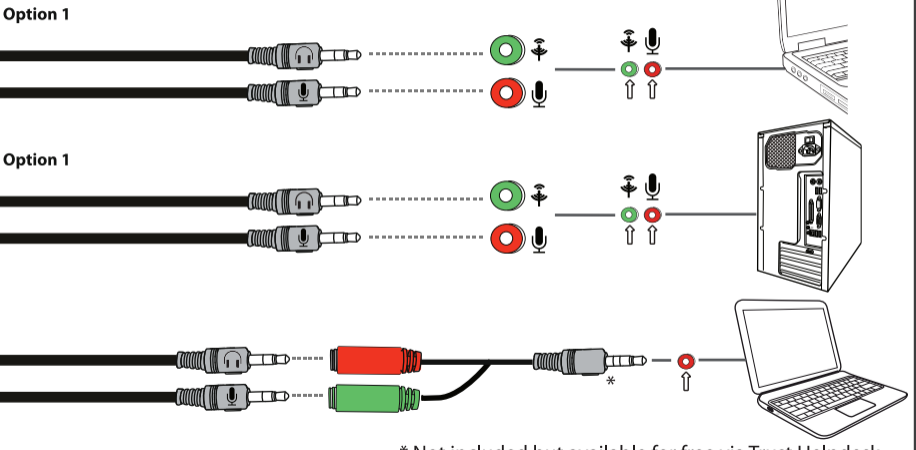

# 3. Installation 1/3

