

TCL

Q75H

5.1.2 Channel Dolby Atmos Soundbar with Wireless Subwoofer Quick Start Guide



English | Albanian | Bulgarian | Croatian | Czech | Danish | Dutch | Estonian | Finnish | French | German | Greek | Hungarian | Italian | Latvian | Lithuanian | Macedonian | Norwegian | Polish | Portuguese | Romanian | Russian | Serbian | Slovak | Slovene | Spanish | Swedish | Turkish | Ukrainian



EN Make sure you read all the safety information before you use this product.

SQ Sigurohuni që të lexoni të gjithë informacionin e sigurisë përpara se të përdorni produktin.

BG Преди да използвате продукта, задължително прочетете всички инструкции за безопасност.

HR Obavezno pročitajte sve sigurnosne informacije prije korištenja ovog proizvoda.

CZ Před použitím tohoto výrobku si přečtěte všechny bezpečnostní informace.

DA Læs alle sikkerhedsoplysninger, før du bruger produktet.

NL Zorg ervoor dat u alle veiligheidsinformatie leest voordat u dit apparaat gebruikt.

ET Enne seadme kasutamist lugege kindlasti kõiki ohutuseeskirju.

FI Lue kaikki turvallisuusohjeet ennen tuotteen käyttöä.

FR Assurez-vous d'avoir lu toutes les informations relatives à la sécurité avant d'utiliser cet appareil.

DE Vergewissern Sie sich, dass Sie sämtliche Sicherheitshinweise gelesen haben, bevor Sie dieses Produkt verwenden.

EL Βεβαιωθείτε ότι έχετε διαβάσει όλες τις πληροφορίες ασφαλείας πριν χρησιμοποιήσετε αυτό το προϊόν.

HU A készülék használatba vétele előtt olvassa el az összes biztonsági előírást.

IT Assicurarsi di aver letto tutte le informazioni sulla sicurezza prima di utilizzare questo prodotto.

LV Pirms produkta lietošanas noteikti izlasiet visu drošības informāciju.

LT Prieš pradėjami naudoti šį gaminį, būtina perskaitykite visus saugos nurodymus.

MK Погрижете се да ги прочитате сите безбедносни информации пред да го користите овој производ.

NO Sorg for å lese alle sikkerhetsinstruksjonene før du bruker produktet.

PL Przed użyciem produktu należy dokładnie przeczytać wszystkie wskazówki dotyczące bezpieczeństwa.

PT Certifique-se de ler todas as informações de segurança antes de usar este produto.

RO Asigurați-vă că ați citit toate informațiile de siguranță înainte de a utiliza acest produs.

RU Прежде чем приступить к эксплуатации устройства, прочтите все инструкции по безопасности.

SR Obavezno pročitajte sve informacije o bezbednosti pre nego što koristite ovaj proizvod.

SK Pred použitím tohto produktu si prečítajte všetky bezpečnostné informácie.

SL Zagotovite, da ste pred uporabo tega izdelka prebrali vse varnostne informacije.

ES Asegúrese de leer toda la información de seguridad antes de utilizar este producto.

SV Se till att du läser all säkerhetsinformation innan du använder produkten.

TR Bu ürünü kullanmadan önce tüm güvenlik bilgilerini okuduğunuzdan emin olun.

UA Уважно ознайомтеся із усією інформацією стосовно техніки безпеки перед використанням пристрою.

A

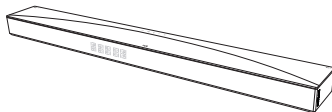

B

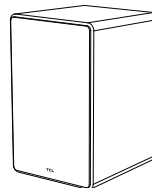

C x 2



D



E

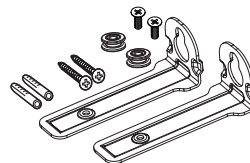

F

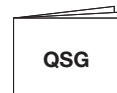

G

Safety
instructions

H

Warranty
card

I

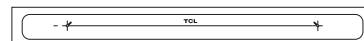

2a



A

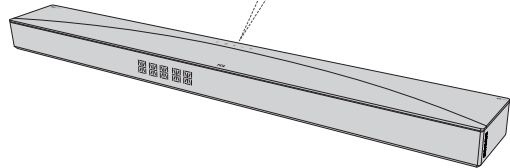
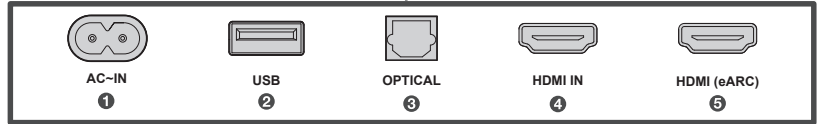
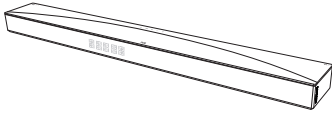

2b



B

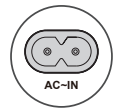
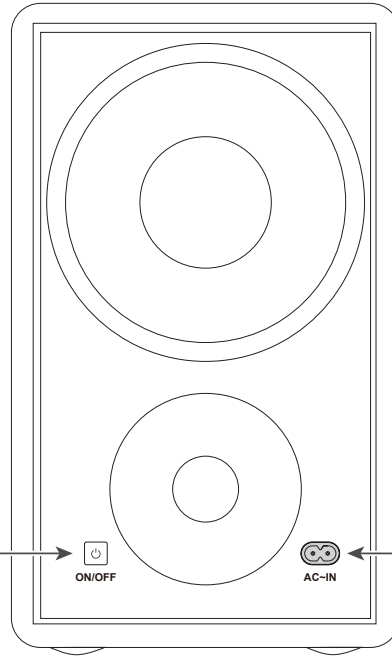
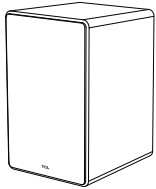

2c



A

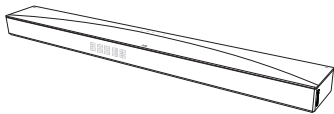

B

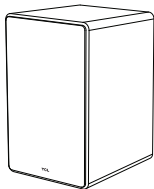

1

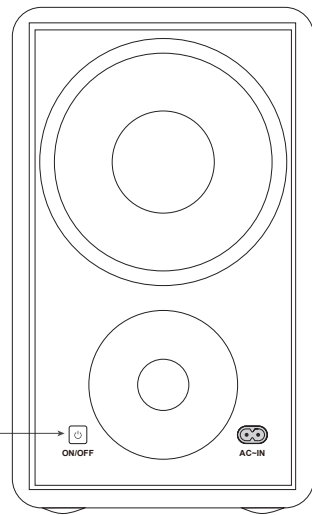
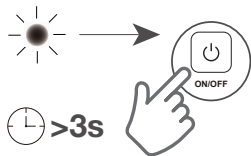

2

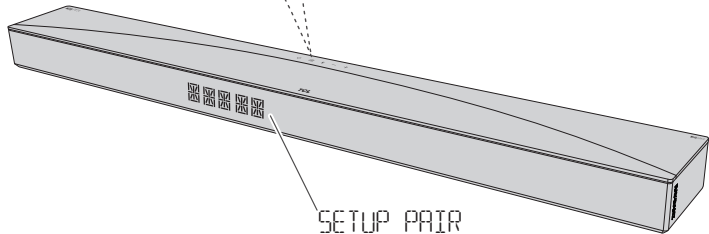



The Soundbar LED display indicates various Soundbar functions.

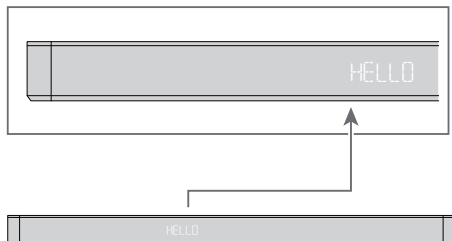

	Soundbar Status	LED Display Status
Power	Power on Power off	HELLO STDBY / SLEEP
Source	HDMI eARC/ARC Optical USB Bluetooth HDMI IN	HDMI eARC OPT USB BT HDMI IN
Bluetooth	Searching mode (flashing) Pairing mode	BT PAIRING
Volume control	Volume level Minimum volume reached Maximum volume reached Mute	V 36 MIN MAX MUTE
Audio setting	Bass (+/-) Treble (+/-) Voice Enhance Surround Enhance AI SONIC Pass Through Night	BAS LOW / BAS MEDIUM / BAS HIGH TRE LOW / TRE MEDIUM / TRE HIGH VOICE ON / VOICE OFF SURR ON / SURR OFF POSITION 1 / POSITION 2 / POSITION 3 / OFF PASS THROUGH / -X- & PASS THROUGH NIGHT ON / NIGHT OFF
Sound modes	Standard/Movie/Music/ Voice/Game/Sports	STANDARD MOVIE MUSIC VOICE GAME SPORTS
Light	Light Setting	LIGHT 1 / LIGHT 2 / LIGHT 3



Ekрани LED i Soundbar tregon funksione të ndryshme të Soundbar.

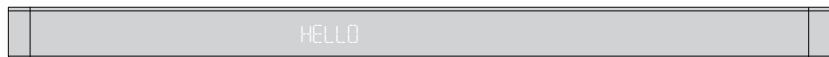
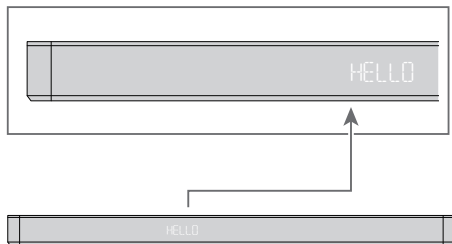

	Gjendja e Soundbar	Gjendja e shfaqjes LED
Fuqia	Ndezja Fikja	HELLO STDBY / SLEEP
Burimi	HDMI eARC/ARC Optike USB Bluetooth HDMI IN	HDMI eARC OPT USB BT HDMI IN
Bluetooth	Modaliteti i Searching (Kërkimit) (Flashing) Modaliteti i Pairing (Çiftimit)	BT PAIRING
Kontrolli i volumit	Niveli i volumit Volumi minimal i arritur Volumi maksimal i arritur Memec	V 36 MIN MAX MUTE
Rregullimet audio	Bas (+/-) Treble (+/-) Zmadhimi i zërit Përmirësimi i mjedisit rrethues AI SONIC	BAS LOW / BAS MEDIUM / BAS HIGH TRE LOW / TRE MEDIUM / TRE HIGH VOICE ON / VOICE OFF SURR ON / SURR OFF POSITION 1 / POSITION 2 / POSITION 3 / OFF
	Kaloni përmes Natën	PASS THROUGH / -X- & PASS THROUGH NIGHT ON / NIGHT OFF
Modaliteti i zërit	Standard/Film/Muzikë /Zë/Lojë/Sport	STANDARD MOVIE MUSIC VOICE GAME SPORTS
Drita	Rregullimet e ndriçimit	LIGHT 1 / LIGHT 2 / LIGHT 3



LED дисплеят на саундбара показва различни функции на саундбара.

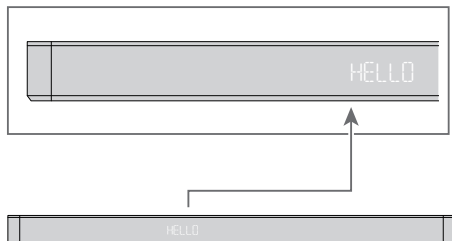

	Състояние на саундбара	Състояние на LED дисплея
Власт	Включване Изключване	HELLO STBY / SLEEP
Източник	HDMI eARC/ARC Оптичен USB Bluetooth HDMI IN	HDMI eARC OPT USB BT HDMI IN
Bluetooth	Режим на Searching (Търсене) (мигащ) Режим на Pairing (Сдвояване)	BT PAIRING
Контрол на силата на звука	Ниво на звука Достигнатият минимален обем Достигнатият максимален обем Изключване на звука	V 36 MIN MAX MUTE
Настройки на звука	Бас(+/-) Високи честоти (+/-) Гласово подобрение Подобряване на съраунда AI SONIC	BAS LOW / BAS MEDIUM / BAS HIGH TRE LOW / TRE MEDIUM / TRE HIGH VOICE ON / VOICE OFF SURR ON / SURR OFF POSITION 1 / POSITION 2 / POSITION 3 / OFF
	Преминаване през Нощем	PASS THROUGH / -X- & PASS THROUGH NIGHT ON / NIGHT OFF
Звуков режим	Стандарт/Филм/Музика/ Глас/Игра/Спорт	STANDARD MOVIE MUSIC VOICE GAME SPORTS
Светлина	Настройки на осветлението	LIGHT 1 / LIGHT 2 / LIGHT 3



LED zaslon zvučne trake označava različite funkcije zvučne trake.

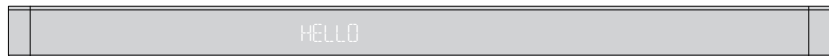
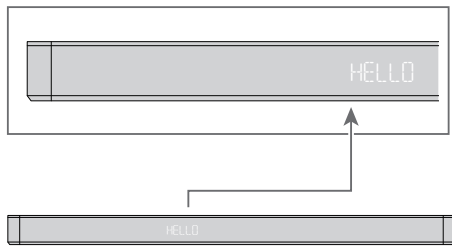

	Stanje zvučne Trake	Stanje LED zaslona
Moć	Uključivanje Isključivanje	HELLO STDBY / SLEEP
Izvor	HDMI eARC/ARC Optički USB Bluetooth HDMI IN	HDMI eARC OPT USB BT HDMI IN
Bluetooth	Searching mode (Način pretraživanja) (treperi) Pairing mode (Način uparivanja)	BT PAIRING
Kontrola glasnoće	Razina glasnoće Minimalni dosegnuti glasnoća Maksimalna dosegnuta glasnoća Čutljiv	V 36 MIN MAX MUTE
Audio postavke	Bas (+/-) Treble (+/-) Poboljšanje Glasa Poboljšanje Surround Zvuka AI SONIC	BAS LOW / BAS MEDIUM / BAS HIGH TRE LOW / TRE MEDIUM / TRE HIGH VOICE ON / VOICE OFF SURR ON / SURR OFF POSITION 1 / POSITION 2 / POSITION 3 / OFF
	Proći Noću	PASS THROUGH / -X- & PASS THROUGH NIGHT ON / NIGHT OFF
Način zvuka	Standard/Film/Glazba/ Glas/Igra/Sport	STANDARD MOVIE MUSIC VOICE GAME SPORTS
Svjetlo	Postavke Osvjetljenja	LIGHT 1 / LIGHT 2 / LIGHT 3



LED displej soundbaru zobrazuje různé funkce soundbaru.

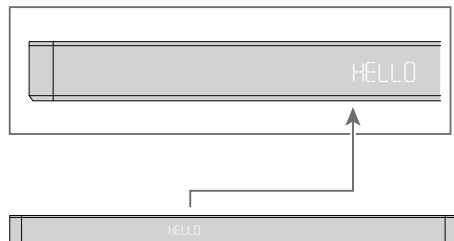

	Stav soundbaru	Stav LED displeje
Moc	Zapnutí Vypínání	HELLO STDBY / SLEEP
Zdroj	HDMI eARC/ARC Optický USB Bluetooth HDMI IN	HDMI eARC OPT USB BT HDMI IN
Bluetooth	Režim Searching (vyhledávání) (blikající) Režim Pairing (párování)	BT PAIRING
Ovládání hlasitosti	Úroveň hlasitosti Dosažena minimální hlasitost Dosažena maximální hlasitost Ztlumit	V 36 MIN MAX MUTE
Nastavení zvuku	Basy (+/-) Výšky (+/-) Vylepšení hlasu Vylepšení prostorového zvuku AI SONIC	BAS LOW / BAS MEDIUM / BAS HIGH TRE LOW / TRE MEDIUM / TRE HIGH VOICE ON / VOICE OFF SURR ON / SURR OFF POSITION 1 / POSITION 2 / POSITION 3 / OFF
	Zažívat Noci	PASS THROUGH / -X- & PASS THROUGH NIGHT ON / NIGHT OFF
Režim zvuku	Standardní/Film/ Hudba/Hlas/Hra/Sport	STANDARD MOVIE MUSIC VOICE GAME SPORTS
Světlo	Nastavení osvětlení	LIGHT 1 / LIGHT 2 / LIGHT 3



Soundbar LED-displayet viser forskellige Soundbar-funktioner.

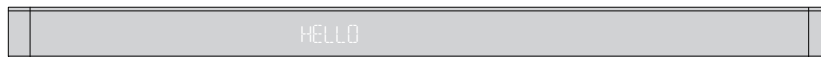
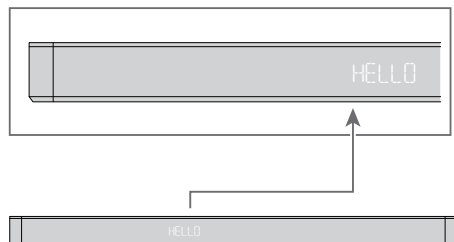

	Soundbar-status	LED-displayets status
Strømforsyning	Tænd for strømmen Sluk for strømmen	HELLO STDBY / SLEEP
Kilde	HDMI eARC/ARC Optisk USB Bluetooth HDMI IN	HDMI eARC OPT USB BT HDMI IN
Bluetooth	Searching mode (Søgetilstand) (blinker) Pairing mode (Parringstilstand)	BT PAIRING
Lydstyrkekontrol	Lydstyreniveau Mindste volumen nået Maksimal volumen nået Stum	V 36 MIN MAX MUTE
Lydindstillinger	Bas (+/-) Diskant (+/-) Taleforbedring Surround-forbedring AI SONIC Direkte Nat	BAS LOW / BAS MEDIUM / BAS HIGH TRE LOW / TRE MEDIUM / TRE HIGH VOICE ON / VOICE OFF SURR ON / SURR OFF POSITION 1 / POSITION 2 / POSITION 3 / OFF PASS THROUGH / -X- & PASS THROUGH NIGHT ON / NIGHT OFF
Lydtilstand	Standard/Film/Musik/ Stemme/Spil/Sport	STANDARD MOVIE MUSIC VOICE GAME SPORTS
Lys	Belysningsindstillinger	LIGHT 1 / LIGHT 2 / LIGHT 3



Het LED-display van de soundbar geeft verschillende soundbarfuncties weer.

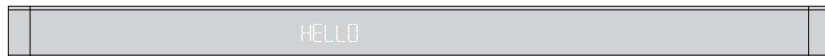
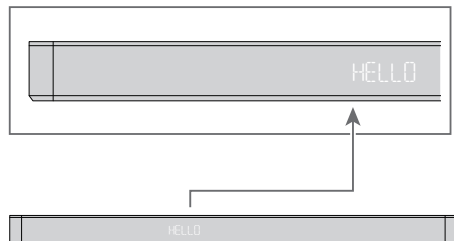

	Soundbar-status	Status LED-display
Stroomvoorziening	Aanzetten Uitschakelen	HELLO STBY / SLEEP
Bron	HDMI eARC/ARC Optisch USB Bluetooth HDMI ingang	HDMI eARC OPT USB BT HDMI IN
Bluetooth	Searching mode (Zoekmodus) (knipperen) Pairing mode (Koppelingsmodus)	BT PAIRING
Volumeregeling	Volumeniveau Minimaal volumeniveau bereikt Maximaal volumeniveau bereikt Dempen	V 36 MIN MAX MUTE
Audio-instellingen	Bas (+/-) Hoge tonen (+/-) Spraakverbetering Surround sound versterking AI SONIC Direct Nacht	BAS LOW / BAS MEDIUM / BAS HIGH TRE LOW / TRE MEDIUM / TRE HIGH VOICE ON / VOICE OFF SURR ON / SURR OFF POSITION 1 / POSITION 2 / POSITION 3 / OFF PASS THROUGH / -X- & PASS THROUGH NIGHT ON / NIGHT OFF
Geluidsmodus	Standaard/Films/Muziek/ Spraak/Games/Sporten	STANDARD MOVIE MUSIC VOICE GAME SPORTS
Lichtmodus	Verlichtingsinstellingen	LIGHT 1 / LIGHT 2 / LIGHT 3



Helibari LED-ekraan näitab erinevaid helibari funktsioone.

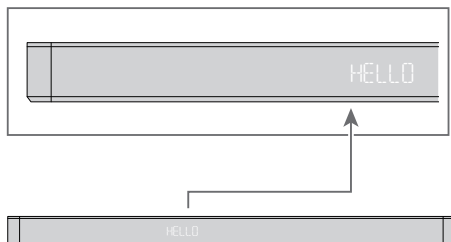

	Helibari staatus	LED-ekraani olek
Toiteallikas	Sisse lülitada Väljalülitamine	HELLO STBY / SLEEP
Allikas	HDMI eARC/ARC Optiline USB Bluetooth HDMI sisend	HDMI eARC OPT USB BT HDMI IN
Bluetooth	Searching mode (Otsingurežiim) (vilkv) Pairing mode (Sidumisrežiim)	BT PAIRING
Helitugevuse reguleerimine	Helitugevuse tase Minimaalne saavutatud helitugevuse tase Maksimaalne saavutatud helitugevuse tase Mute	V 36 MIN MAX MUTE
Heli seaded	Bass (+/-) Treble (+/-) Kõne võimendamine Surround-heli võimendamine AI SONIC	BAS LOW / BAS MEDIUM / BAS HIGH TRE LOW / TRE MEDIUM / TRE HIGH VOICE ON / VOICE OFF SURR ON / SURR OFF POSITION 1 / POSITION 2 / POSITION 3 / OFF
	Otse Õõ	PASS THROUGH / -X- & PASS THROUGH NIGHT ON / NIGHT OFF
Helirežiim	Standard/filmid/ muusika/kõne/mängud/sport	STANDARD MOVIE MUSIC VOICE GAME SPORTS
Valgusrežiim	Valgustuse seaded	LIGHT 1 / LIGHT 2 / LIGHT 3



Soundbarin LED-näytössä näkyvät soundbarin eri toiminnot.

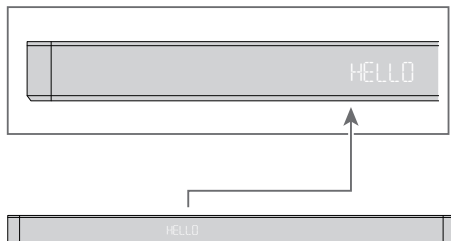

	Soundbarin tila	LED-näytön tila
Virtalähde	Kytke päälle Kytke pois päältä	HELLO STBY / SLEEP
Lähde	HDMI eARC/ARC Optinen USB Bluetooth HDMI-tulo	HDMI EARC OPT USB BT HDMI IN
Bluetooth	Searching Mode (Hakutila) (vilkkuu) Pairing Mode (Yhteystila)	BT PAIRING
Äänenvoimakkuuden säätö	Äänenvoimakkuus Pienin saavutettu äänenvoimakkuuden taso Suurin saavutettu äänenvoimakkuus Mykistys	V 36 MIN MAX MUTE
Ääniasetukset	Basso (+/-) Diskantti (+/-) Puheen vahvistus Surround-äänen vahvistus AI SONIC	BAS LOW / BAS MEDIUM / BAS HIGH TRE LOW / TRE MEDIUM / TRE HIGH VOICE ON / VOICE OFF SURR ON / SURR OFF POSITION 1 / POSITION 2 / POSITION 3 / OFF
	Suora Yö	PASS THROUGH / -X- & PASS THROUGH NIGHT ON / NIGHT OFF
Äänitila	Vakio/elokuvat/musiikki/puhe/pelit/urheilu	STANDARD MOVIE MUSIC VOICE GAME SPORTS
Valotila	Valaistusasetukset	LIGHT 1 / LIGHT 2 / LIGHT 3



L'écran LED de la barre de son indique les différentes fonctions de la barre de son.

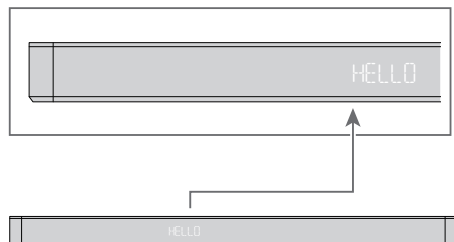

	État de la barre de son	État d'affichage LED
Alimentation	Mise sous tension Mise hors tension	HELLO STBY / SLEEP
Source	HDMI eARC/ARC Optique USB Bluetooth ENTRÉE HDMI	HDMI eARC OPT USB BT HDMI IN
Bluetooth	Mode de recherche (clignotant) Mode d'appairage	BT PAIRING
Contrôle du volume	Niveau de volume Volume minimal atteint Volume maximal atteint Muet	V 36 MIN MAX MUTE
Réglage audio	Basses (+/-) Aigus (+/-) Amélioration Voix Amélioration Ambiophonie SONIQUE AI	BAS LOW / BAS MEDIUM / BAS HIGH TRE LOW / TRE MEDIUM / TRE HIGH VOICE ON / VOICE OFF SURR ON / SURR OFF POSITION 1 / POSITION 2 / POSITION 3 / OFF
	Passer Nuit	PASS THROUGH / -X- & PASS THROUGH NIGHT ON / NIGHT OFF
Modes sonores	Standard/Film/Musique/ Voix/Jeu/Sport	STANDARD MOVIE MUSIC VOICE GAME SPORTS
Voyant	Réglage du voyant	LIGHT 1 / LIGHT 2 / LIGHT 3



Die LED-Anzeige der Soundbar zeigt verschiedene Soundbar-Funktionen an.

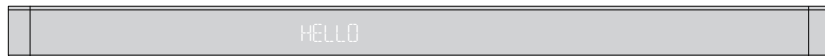
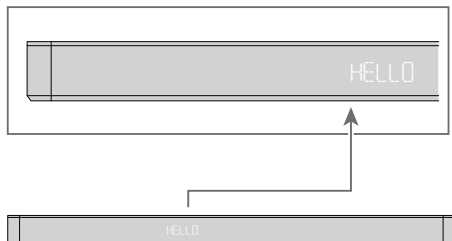

	Soundbar-Status	LED-Anzeigestatus
Stromversorgung	Einschalten Ausschalten	HELLO STBY / SLEEP
Quelle	HDMI eARC/ARC Optisch USB Bluetooth HDMI-Eingang	HDMI eARC OPT USB BT HDMI IN
Bluetooth	Searching Mode (Suchmodus) (blinkend) Pairing Mode (Kopplungsmodus)	BT PAIRING
Lautstärkesteuerung	Lautstärkeniveau Minimale Lautstärke erreicht Maximale Lautstärke erreicht Stumm	V 36 MIN MAX MUTE
Audio Einstellungen	Bass (+/-) Hohe Töne (+/-) Sprachverbesserung Surround-Sound-Verbesserung AI SONIC	BAS LOW / BAS MEDIUM / BAS HIGH TRE LOW / TRE MEDIUM / TRE HIGH VOICE ON / VOICE OFF SURR ON / SURR OFF POSITION 1 / POSITION 2 / POSITION 3 / OFF
	Direkte Nacht	PASS THROUGH / -X- & PASS THROUGH NIGHT ON / NIGHT OFF
Klangmodus	Standard/Filme/ Musik/Sprache/Spiele/Sport	STANDARD MOVIE MUSIC VOICE GAME SPORTS
Licht	Beleuchtungseinstellungen	LIGHT 1 / LIGHT 2 / LIGHT 3



Η οθόνη LED της γραμμής ήχου υποδεικνύει τις διάφορες λειτουργίες της γραμμής ήχου.

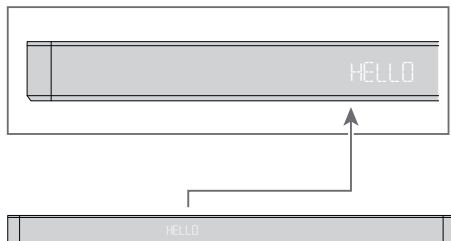

	Κατάσταση ηχομπάρας	Κατάσταση οθόνης LED
Τροφοδοσία	Ενεργοποίηση Απενεργοποίηση	HELLO STBY / SLEEP
Πηγή	HDMI eARC/ARC Οπτικός USB Bluetooth ΕΙΣΟΔΟΣ HDMI	HDMI EARC OPT USB BT HDMI IN
Bluetooth	Λειτουργία Searching (Αναζήτησης) (αναβοσβήνει) Λειτουργία pairing (σύζευξης)	BT PAIRING
Έλεγχος έντασης ήχου	Επίπεδο έντασης Φτάσει στο ελάχιστο ποσό Φτάσει στο μέγιστο όγκο Σίγαση	V 36 MIN MAX MUTE
Ρυθμίσεις ήχου	Μπάσο (+/-) Τριμπλ (+/-) Βελτίωση Φωνής Ενίσχυση περιβάλλον AI SONIC	BAS LOW / BAS MEDIUM / BAS HIGH TRE LOW / TRE MEDIUM / TRE HIGH VOICE ON / VOICE OFF SURR ON / SURR OFF POSITION 1 / POSITION 2 / POSITION 3 / OFF
	Πέρασμα Νύχτα	PASS THROUGH / -X- & PASS THROUGH NIGHT ON / NIGHT OFF
Λειτουργία ήχου	Πρότυπο/Ταινίες/Μουσική/Φωνή/Παιχνίδια/Αθλητισμός	STANDARD MOVIE MUSIC VOICE GAME SPORTS
Πηγή φωτός	Ρυθμίσεις φωτισμού	LIGHT 1 / LIGHT 2 / LIGHT 3



A Hangsáv LED-kijelzője jelzi a Hangsáv különböző funkcióit.

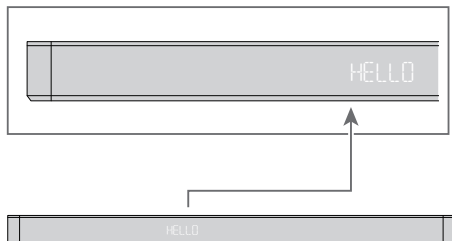

	Hangsáv állapota	LED kijelző állapota
Tápegység	Bekapcsolás Kikapcsolás	HELLO STBY / SLEEP
Forrás	HDMI eARC/ARC Optikai USB Bluetooth HDMI IN	HDMI eARC OPT USB BT HDMI IN
Bluetooth	Searching (Keresési) mód (villog) Pairing (Párosítási) mód	BT PAIRING
Hangerőszabályozó	Hangerőszint Eléri a minimális összeget Eléri a maximális hangerőt Csend	V 36 MIN MAX MUTE
Hangbeállítások	Basszus (+/-) Magas (+/-) Beszédkiemelés Térhatású hangzás fokozása AI SONIC	BAS LOW / BAS MEDIUM / BAS HIGH TRE LOW / TRE MEDIUM / TRE HIGH VOICE ON / VOICE OFF SURR ON / SURR OFF POSITION 1 / POSITION 2 / POSITION 3 / OFF
	Közvetlen Éjszaka	PASS THROUGH / -X- & PASS THROUGH NIGHT ON / NIGHT OFF
Hang mód	Normál/Filmek/Zene/Hang/ Játékok/Sport	STANDARD MOVIE MUSIC VOICE GAME SPORTS
Fény	Világítási beállítások	LIGHT 1 / LIGHT 2 / LIGHT 3



Il display a LED della Soundbar indica le varie funzioni della Soundbar .

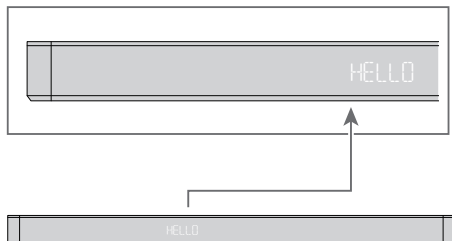

	Stato della Soundbar	Stato del display a LED
Potenza	Accensione Spegnimento	HELLO STDBY / SLEEP
Fonte	HDMI eARC/ARC Ottico USB Bluetooth HDMI IN	HDMI eARC OPT USB BT HDMI IN
Bluetooth	Modalità di Searching (Ricerca) (lampeggiante) Modalità di Pairing (Accoppiamento)	BT PAIRING
Controllo del volume	Livello del volume Volume minimo raggiunto Volume massimo raggiunto Silenziamento	V 36 MIN MAX MUTE
Impostazione audio	Bassi (+/-) Alti (+/-) Miglioramento della voce Miglioramento surround AI SONIC	BAS LOW / BAS MEDIUM / BAS HIGH TRE LOW / TRE MEDIUM / TRE HIGH VOICE ON / VOICE OFF SURR ON / SURR OFF POSITION 1 / POSITION 2 / POSITION 3 / OFF
	Passare attraverso Notte	PASS THROUGH / -X- & PASS THROUGH NIGHT ON / NIGHT OFF
Modalità audio	Standard/Film/Musica/Voce/ Gioco/Sport	STANDARD MOVIE MUSIC VOICE GAME SPORTS
Luce	Impostazione luce	LIGHT 1 / LIGHT 2 / LIGHT 3



Sound Bar LED displejs norāda uz dažādām Sound Bar funkcijām.

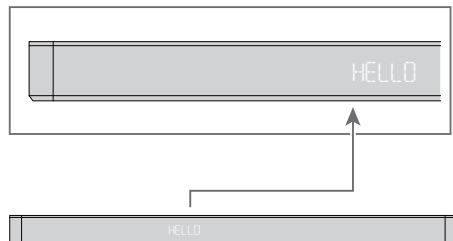

	Soundbar Statuss	LED Displejs Statuss
Enerģijas padeve	Ieslēgšana Izslēgšana	HELLO STBY / SLEEP
Avots	HDMI eARC/ARC Optiskais USB Bluetooth HDMI IN	HDMI EARC OPT USB BT HDMI IN
Bluetooth	Searching mode (Meklēšanas režīms) (mirgo) Pairing mode (Savienošanas pāri režīms)	BT PAIRING
Skaļuma kontrole	Skaļuma līmenis Sasniegt minimālo skaļumu Sasniegt maksimālo skaļumu Klusējošs	V 36 MIN MAX MUTE
Audio iestatījumi	Bass (+/-) Diskants (+/-) Runas Uzlabošana Telpiskās Skaņas Uzlabošana MĪLU SKAŅU Caurlaide Nakts	BAS LOW / BAS MEDIUM / BAS HIGH TRE LOW / TRE MEDIUM / TRE HIGH VOICE ON / VOICE OFF SURR ON / SURR OFF POSITION 1 / POSITION 2 / POSITION 3 / OFF PASS THROUGH / -X- & PASS THROUGH NIGHT ON / NIGHT OFF
Skaņas režīms	Standarta/Filmas/Mūzika/ Balss/Spēles/Sports	STANDARD MOVIE MUSIC VOICE GAME SPORTS
Gaisma	Apgaismojuma iestatījumi	LIGHT 1 / LIGHT 2 / LIGHT 3



Garso Juostos LED ekranas rodo įvairias
Garso Juostos funkcijas.

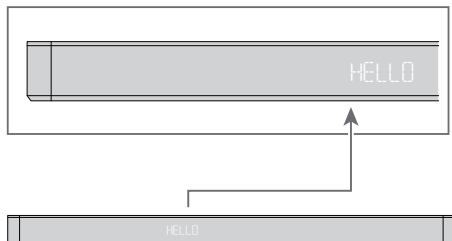

	Garso juostos Būsena	LED Ekranu Būsena
Maitinimo šaltinis	Įjungimas Išjungimas	HELLO STDBY / SLEEP
Šaltinis	HDMI eARC/ARC Optinis USB Bluetooth HDMI IN	HDMI eARC OPT USB BT HDMI IN
Bluetooth	Searching mode (Paieškos režimas) (mirksi) Pairing mode (Poravimo režimas)	BT PAIRING
Garso valdymas	Garsumo lygis Pasiekti minimalią garsumą Pasiekti maksimalų garsumą Tyli	V 36 MIN MAX MUTE
Garso nustatymus	Bosas (+/-) Aukštai (+/-) Kalbos Stiprinimas Erdvinio Garso Patobulinimas AI SONIC Praeiti Naktis	DPS LOW / DPS MEDIUM / DPS HIGH TRE LOW / TRE MEDIUM / TRE HIGH VOICE ON / VOICE OFF SURR ON / SURR OFF POSITION 1 / POSITION 2 / POSITION 3 / OFF PASS THROUGH / -X- & PASS THROUGH NIGHT ON / NIGHT OFF
Garso režimas	Standartinis/Filmai/Muzika/ Balsas/Žaidimai/Sportas	STANDARD MOVIE MUSIC VOICE GAME SPORTS
Šviesa	Apšvietimo Nustatymai	LIGHT 1 / LIGHT 2 / LIGHT 3



LED екранот на звучната лента ги покажува различните функции на Лентата За Звук.

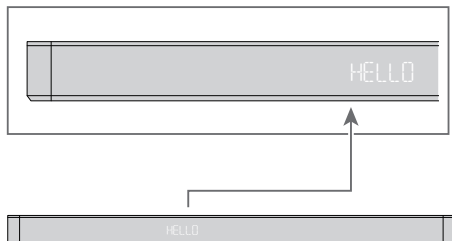

	Статус На Звучната Лента	Статус На LED Дисплејот
Напојување	Вклучување Исклучување	HELLO STBY / SLEEP
Извор	HDMI earc/ARC Оптика USB Bluetooth HDMI влез	HDMI EARC OPT USB BT HDMI IN
Bluetooth	Searching mode (Режим на пребарување) (трепка) Pairing mode (Режим на спарување)	BT PAIRING
Контрола на јачината на звукот	Ниво на јачина на звук Достигне минимален јачина Достигне максимална јачина Молчи	V 36 MIN MAX MUTE
Аудио поставки	Бас (+/-) Тројни (+/-) Подобрување На Говорот Подобрување На Опкружувачки Звук AI SONIC	BAS LOW / BAS MEDIUM / BAS HIGH TRE LOW / TRE MEDIUM / TRE HIGH VOICE ON / VOICE OFF SURR ON / SURR OFF POSITION 1 / POSITION 2 / POSITION 3 / OFF
	Помине Ноке	PASS THROUGH / -X- & PASS THROUGH NIGHT ON / NIGHT OFF
Режим на звук	Стандарден/филм/музика /глас/игри/спорт	STANDARD MOVIE MUSIC VOICE GAME SPORTS
Светлина	Поставки за осветлување	LIGHT 1 / LIGHT 2 / LIGHT 3



Lydplanke LED-skjermen viser ulike Sound Bar-funksjoner.

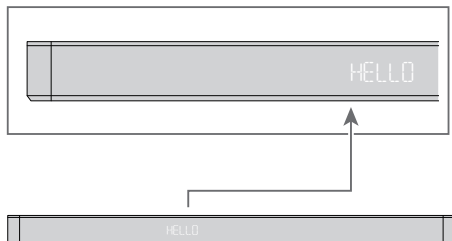

	Soundbar-status	LED-skjermstatus
Makt	Strøm på Strøm av	HELLO STDBY / SLEEP
Kilde	HDMI eARC/ARC Optisk USB Bluetooth HDMI IN	HDMI eARC OPT USB BT HDMI IN
Bluetooth	Searching mode (Søkemodus) (blinker) Pairing mode (Paringsmodus)	BT PAIRING
Volumkontroll	Volumnivå Minimum volum nådd Maksimalt volum nådd Stum	V 36 MIN MAX MUTE
Lydinnstillinger	Bass (+/-) Diskant (+/-) Taleforbedring Surround-forbedrings AI SONIC Pass gjennom Natt	BAS LOW / BAS MEDIUM / BAS HIGH TRE LOW / TRE MEDIUM / TRE HIGH VOICE ON / VOICE OFF SURR ON / SURR OFF POSITION 1 / POSITION 2 / POSITION 3 / OFF PASS THROUGH / -X- & PASS THROUGH NIGHT ON / NIGHT OFF
Lydmoduser	Standard/Filmer/Musikk/ Stemme/Spill/Sport	STANDARD MOVIE MUSIC VOICE GAME SPORTS
Lys	Lysinnstillinger	LIGHT 1 / LIGHT 2 / LIGHT 3



Wyświetlacz LED listwy dźwiękowej wskazuje różne funkcje listwy dźwiękowej.

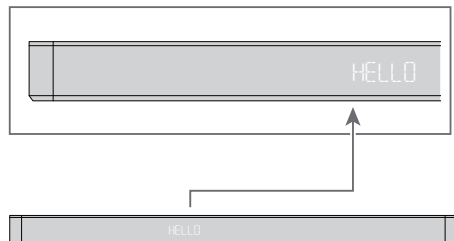

	Stan głośnika SoundBar	Stan na wyświetlaczu LED
Zasilanie	Zasilanie włączone Zasilanie wyłączenie	HELLO STDBY / SLEEP
Źródło	HDMI eARC/ARC Optyczny USB Bluetooth HDMI IN	HDMI EARC OPT USB BT HDMI IN
Bluetooth	Tryb Searching (Wyszukiwania) (migający) Tryb Pairing (Powiązania)	BT PAIRING
Regulacja głośności	Poziom głośności Osiągnięty najniższy poziom głośności Osiągnięty najwyższy poziom głośności Cichy	V 36 MIN MAX MUTE
Ustawienia dźwięku	Bas (+/-) Tony wysokie (+/-) Poprawy Mowy Wzmocnienie Dźwięku Przestrzennego AI SONIC	BAS LOW / BAS MEDIUM / BAS HIGH TRE LOW / TRE MEDIUM / TRE HIGH VOICE ON / VOICE OFF SURR ON / SURR OFF POSITION 1 / POSITION 2 / POSITION 3 / OFF
	Przejrzystość Nocny	PASS THROUGH / -X- & PASS THROUGH NIGHT ON / NIGHT OFF
Tryby dźwięku	Standardowy/Filmy/ Muzyka/Głos/Gry/Sport	STANDARD MOVIE MUSIC VOICE GAME SPORTS
Światło	Ustawienia Oświetlenia	LIGHT 1 / LIGHT 2 / LIGHT 3



O ecrã LED da Barra de Som indica várias funções da Barra de Som.

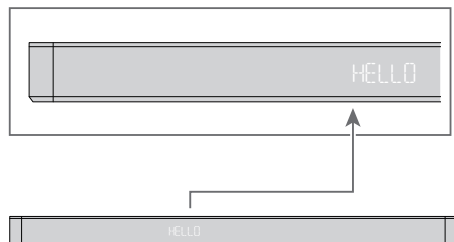

	Estado da Barra de Som	Estado do Ecrã LED
Fonte de alimentação	Ligar Desligar	HELLO STDBY / SLEEP
Fonte	HDMI eARC/ARC Ótica USB Bluetooth HDMI IN	HDMI eARC OPT USB BT HDMI IN
Bluetooth	Modo Searching (Pesquisa) (a piscar) Modo pairing (emparelhamento)	BT PAIRING
Controlo de volume	Nível do volume Volume mínimo atingido Volume máximo atingido Mudo	V 36 MIN MAX MUTE
Configuração de áudio	Graves (+/-) Agudos (+/-) Melhoramento de voz Melhoramento do som surround AI SONIC	BAS LOW / BAS MEDIUM / BAS HIGH TRE LOW / TRE MEDIUM / TRE HIGH VOICE ON / VOICE OFF SURR ON / SURR OFF POSITION 1 / POSITION 2 / POSITION 3 / OFF
	Transparência Noite	PASS THROUGH / -X- & PASS THROUGH NIGHT ON / NIGHT OFF
Modos de som	Padrão/Filme/Música/Voz/ Jogos/Desporto	STANDARD MOVIE MUSIC VOICE GAME SPORTS
Luz	Configuração da luz	LIGHT 1 / LIGHT 2 / LIGHT 3



Afișajul LED al barei de sunet indică diferite funcții ale barei de sunet.

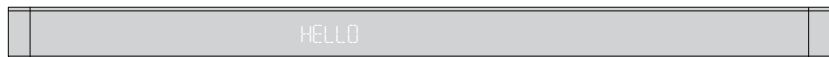
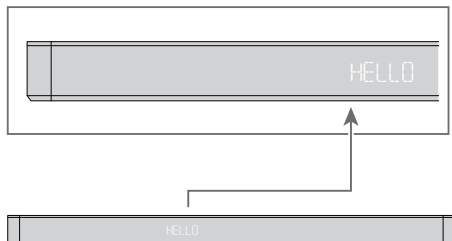

	Starea Sistemului Soundbar	Starea Afișajului LED
Putere	Pornire Oprire	HELLO STDBY / SLEEP
Sursa	HDMI eARC/ARC Optic USB Bluetooth HDMI IN	HDMI eARC OPT USB BT HDMI IN
Bluetooth	Mod de Searching (Căutare) (intermitent) Modul de Pairing (Împerechere)	BT PAIRING
Controlul volumului	Nivelul volumului Volumul minim atins Volumul maxim atins Mute (Mut)	V 36 MIN MAX MUTE
Setări audio	Bas (+/-) Înalte (+/-) Îmbunătățirea Vocii Îmbunătățirea Sunetului Surround AI SONIC Treceți Prin Nocturne	BAS LOW / BAS MEDIUM / BAS HIGH TRE LOW / TRE MEDIUM / TRE HIGH VOICE ON / VOICE OFF SURR ON / SURR OFF POSITION 1 / POSITION 2 / POSITION 3 / OFF PASS THROUGH / -X- & PASS THROUGH NIGHT ON / NIGHT OFF
Modul de sunet	Standard/Film/Muzică/Voce /Joc/Sport	STANDARD MOVIE MUSIC VOICE GAME SPORTS
Lumină	Setări de iluminare	LIGHT 1 / LIGHT 2 / LIGHT 3



Светодиодный дисплей саундбара отображает текущий режим работы.

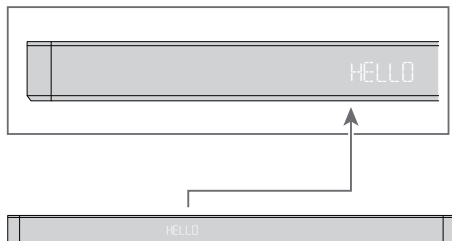

	Состояние саундбара	Состояние светодиодного дисплея
Питание	Включение мощности Отключение мощности	HELLO STBY / SLEEP
Источник	HDMI eARC/ARC Оптический USB Bluetooth HDMI IN	HDMI eARC OPT USB BT HDMI IN
Bluetooth	Режим поиска (мигающий) Режим сопряжения	BT PAIRING
Регулировка громкости	Уровень громкости Достигнут минимум Достигнут максимум Отключение звука	V 36 MIN MAX MUTE
Настройка аудио	Низкая частота (+/-) Высокая частота (+/-) Усиление голоса Усиление объемного звучания ИИ-ЗВУК Сквозной пропуск сигнала Пройти Throu Ночной режим	BAS LOW / BAS MEDIUM / BAS HIGH TRE LOW / TRE MEDIUM / TRE HIGH VOICE ON / VOICE OFF SURR ON / SURR OFF POSITION 1 / POSITION 2 / POSITION 3 / OFF PASS THROUGH / -X- & PASS THROUGH NIGHT ON / NIGHT OFF
Звуковые режимы	Стандарт/Кино/Музыка/ Голос/Игры/Спорт	STANDARD MOVIE MUSIC VOICE GAME SPORTS
Освещение	Настройка освещения	LIGHT 1 / LIGHT 2 / LIGHT 3



LED ekran sound bara prikazuje različite funkcije sound bara.

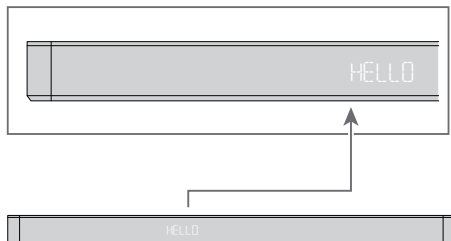

	Status sound bara	Status LED prikaza
Napajanje	Uključi struju Isključi struju	HELLO STDBY / SLEEP
Izvor	HDMI eARC/ARC Optička vlakna USB Bluetooth HDMI IN	HDMI EARC OPT USB BT HDMI IN
Bluetooth	Režim Searching (Pretrage) (flešing) Režim Pairing (Uparivanja)	BT PAIRING
Kontrola jačine zvuka	Nivo jačine zvuka Dostigni minimalnu zapreminu Dostigni maksimalnu jačinu zvuka Nem	V 36 MIN MAX MUTE
Postavke zvuka	Bas (+/-) Treble (+/-) Poboljšanje zvuka Poboljšanje okolnog zvuka AI SONIC Prołaze kroz Noćni	BAS LOW / BAS MEDIUM / BAS HIGH TRE LOW / TRE MEDIUM / TRE HIGH VOICE ON / VOICE OFF SURR ON / SURR OFF POSITION 1 / POSITION 2 / POSITION 3 / OFF PASS THROUGH / -X- & PASS THROUGH NIGHT ON / NIGHT OFF
Režim zvuka	Standard/Movie/ Music/Voice/Game/Sports	STANDARD MOVIE MUSIC VOICE GAME SPORTS
Lampa	Postavke osvetljenja	LIGHT 1 / LIGHT 2 / LIGHT 3



LED displej soundbaru indikuje rôzne funkcie soundbaru.

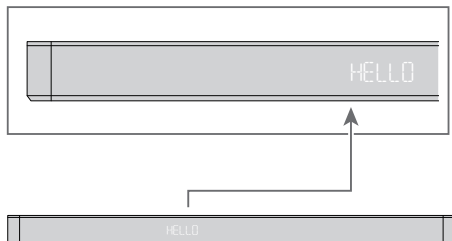

	Stav zvukovej lišty	Stav LED displeja
Sila	Zapnite Vypnite	HELLO STDBY / SLEEP
Zdroj	HDMI eARC/ARC Optický USB Bluetooth HDMI IN	HDMI eARC OPT USB BT HDMI IN
Bluetooth	Režim Searching (Vyhľadávania) (bliká) Režim Pairing (Párovania)	BT PAIRING
Ovládanie hlasitosti	Úroveň hlasitosti Dosiahnutý minimálny objem Dosiahnutá maximálna hlasitosť Stlmiť	V 36 MIN MAX MUTE
Nastavenia zvuku	Basová (+/-) Výšky (+/-) Vylepšenie hlasu Vylepšenie priestorového zvuku AI SONIC	BAS LOW / BAS MEDIUM / BAS HIGH TRE LOW / TRE MEDIUM / TRE HIGH VOICE ON / VOICE OFF SURR ON / SURR OFF POSITION 1 / POSITION 2 / POSITION 3 / OFF
	Prejsť V noci	PASS THROUGH / -X- & PASS THROUGH NIGHT ON / NIGHT OFF
Zvukový režim	Štandardné/Film/ Hudba/Hlas/Hra/Šport	STANDARD MOVIE MUSIC VOICE GAME SPORTS
Svetlo	Nastavenie osvetlenia	LIGHT 1 / LIGHT 2 / LIGHT 3



LED zaslon zvočne vrstice prikazuje različne funkcije zvočne vrstice.

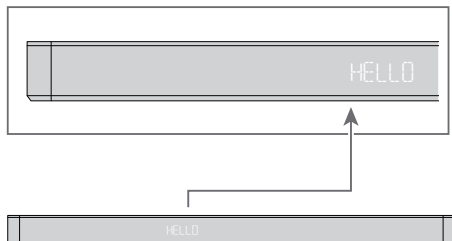

	Stanje zvočne vrstice	Stanje prikaza LED
Moč	Vklop Izklop	HELLO STDBY / SLEEP
Izvir	HDMI eARC/ARC Optičen USB Bluetooth HDMI IN	HDMI eARC OPT USB BT HDMI IN
Bluetooth	Način Searching (Iskanja) (utripa) Način Pairing (Seznanjanja)	BT PAIRING
Nadzor glasnosti	Glasnost Najmanjša dosežena prostornina Največja dosežena glasnost Mute	V 36 MIN MAX MUTE
Nastavitve zvoka	Bas (+/-) Tremor (+/-) Izboljšanje glasu Izboljšava prostorskega zvoka AI SONIC	BAS LOW / BAS MEDIUM / BAS HIGH TRE LOW / TRE MEDIUM / TRE HIGH VOICE ON / VOICE OFF SURR ON / SURR OFF POSITION 1 / POSITION 2 / POSITION 3 / OFF
	Preko Skozi Ponoči	PASS THROUGH / -X- & PASS THROUGH NIGHT ON / NIGHT OFF
Zvočni način	Standardno/Film/ Glasba/Glas/Igra/Šport	STANDARD MOVIE MUSIC VOICE GAME SPORTS
Luč	Nastavitve Osvetlitve	LIGHT 1 / LIGHT 2 / LIGHT 3



La pantalla LED de la barra de sonido indica varias funciones.

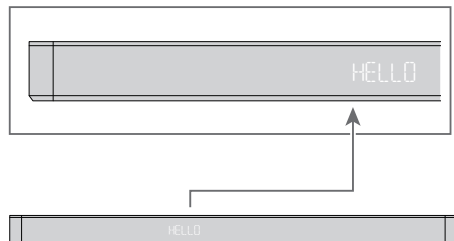

	Estado de la barra de sonido	Estado de la pantalla LED
Potencia	Encendido Apagado	HELLO STDBY / SLEEP
Fuente	HDMI eARC/ARC Óptico USB Bluetooth HDMI IN	HDMI eARC OPT USB BT HDMI IN
Bluetooth	Modo de búsqueda (parpadeo) Modo de emparejamiento	BT PAIRING
Control del volumen	Nivel de volumen Volumen mínimo alcanzado Volumen máximo alcanzado Mudo	V 36 MIN MAX MUTE
Configuración de audio	Graves (+/-) Agudos (+/-) Mejoramiento de Voz Mejoramiento del Sonido Envolverte IA SÓNICA	BAS LOW / BAS MEDIUM / BAS HIGH TRE LOW / TRE MEDIUM / TRE HIGH VOICE ON / VOICE OFF SURR ON / SURR OFF POSITION 1 / POSITION 2 / POSITION 3 / OFF
	Pass Through Nocturno	PASS THROUGH / -X- & PASS THROUGH NIGHT ON / NIGHT OFF
Modos de sonido	Estándar/Película/Música/Voz /Juego/Deportes	STANDARD MOVIE MUSIC VOICE GAME SPORTS
Ligero	Configuración de luz	LIGHT 1 / LIGHT 2 / LIGHT 3



Soundbarens LED-display indikerar olika soundbar-funktioner.

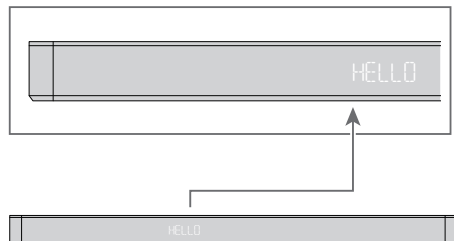

	Soundbarens-status	Status för LED-display
Kraft	Ström PÅ Stäng AV	HELLO STDBY / SLEEP
Källa	HDMI eARC/ARC Optisk USB Bluetooth HDMI IN	HDMI EARC OPT USB BT HDMI IN
Bluetooth	Searching (Sökläge) (blinkande) Pairing (Parningsläge)	BT PAIRING
Volymkontroll	Volymnivå Den minsta volymen har uppnåtts Den maximala volymen har uppnåtts Stum	V 36 MIN MAX MUTE
Ljud inställningar	Bas (+/-) Diskant (+/-) Förbättring av rösten Förbättring av surroundljud AI SONIC	BAS LOW / BAS MEDIUM / BAS HIGH TRE LOW / TRE MEDIUM / TRE HIGH VOICE ON / VOICE OFF SURR ON / SURR OFF POSITION 1 / POSITION 2 / POSITION 3 / OFF
	Passera igenom På natten	PASS THROUGH / -X- & PASS THROUGH NIGHT ON / NIGHT OFF
Ljudläge	Standard/Film/ Musik/Röst/Spel/Sport	STANDARD MOVIE MUSIC VOICE GAME SPORTS
Ljus	Belysning inställningar	LIGHT 1 / LIGHT 2 / LIGHT 3



Soundbar LED ekranı, çeşitli soundbar işlevlerini gösterir.



	Soundbar durumu	LED ekran durumu
Güç	Güç Kapat	HELLO STDBY / SLEEP
Kaynak	HDMI eARC/ARC Optik USB Bluetooth HDMI IN	HDMI eARC OPT USB BT HDMI IN
Bluetooth	Searching (Arama) Modu (Yanıp Sönüyor) Pairing (Esleştirme) modu	BT PAIRING
Ses kontrolü	Ses seviyesi Minimum hacme ulaşıldı Ulaşılan maksimum hacim Dilsiz	V 36 MIN MAX MUTE
Ses ayarları	Bas (+/-) Tiz (+/-) Ses geliştirme Surround ses geliştirme AI SONIC	BAS LOW / BAS MEDIUM / BAS HIGH TRE LOW / TRE MEDIUM / TRE HIGH VOICE ON / VOICE OFF SURR ON / SURR OFF POSITION 1 / POSITION 2 / POSITION 3 / OFF
	Geçmek Geceleyin	PASS THROUGH / -X- & PASS THROUGH NIGHT ON / NIGHT OFF
Ses modu	Standart/Film/ Müzik/Ses/Oyun/Spor	STANDARD MOVIE MUSIC VOICE GAME SPORTS
Işık	Aydınlatma ayarları	LIGHT 1 / LIGHT 2 / LIGHT 3



Світлодіодний дисплей звукової панелі відображає різні функції звукової панелі.

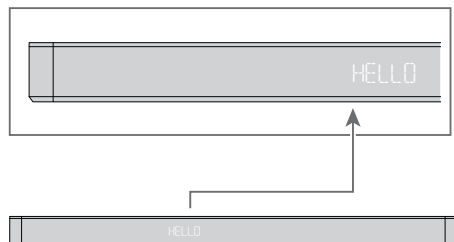

	Стан звукової панелі Soundbar	Стан світлодіодного дисплея
Міць	Увімкнення живлення Вимкніть живлення	HELLO STDBY / SLEEP
Target	HDMI eARC/ARC Оптичні USB Bluetooth HDMI IN	HDMI EARC OPT USB BT HDMI IN
Bluetooth	Режим Searching (пошуку) (блимає) Режим Pairing (сполучення)	BT PAIRING
Регулювання гучності	Рівень гучності Досягнутий мінімальний обсяг Досягнута максимальна гучність Відключення	V 36 MIN MAX MUTE
Налаштування звуку	Баси (+/-) Високі частоти (+/-) Покращення голосу Покращення об'ємного звуку AI SONIC	BAS LOW / BAS MEDIUM / BAS HIGH TRE LOW / TRE MEDIUM / TRE HIGH VOICE ON / VOICE OFF SURR ON / SURR OFF POSITION 1 / POSITION 2 / POSITION 3 / OFF
	Прохід Вночі	PASS THROUGH / -X- & PASS THROUGH NIGHT ON / NIGHT OFF
Звуковий режим	Стандартний/Фільм/ Музика/Голос/Ігри/Спорт	STANDARD MOVIE MUSIC VOICE GAME SPORTS
Світлий	Налаштування освітлення	LIGHT 1 / LIGHT 2 / LIGHT 3

4

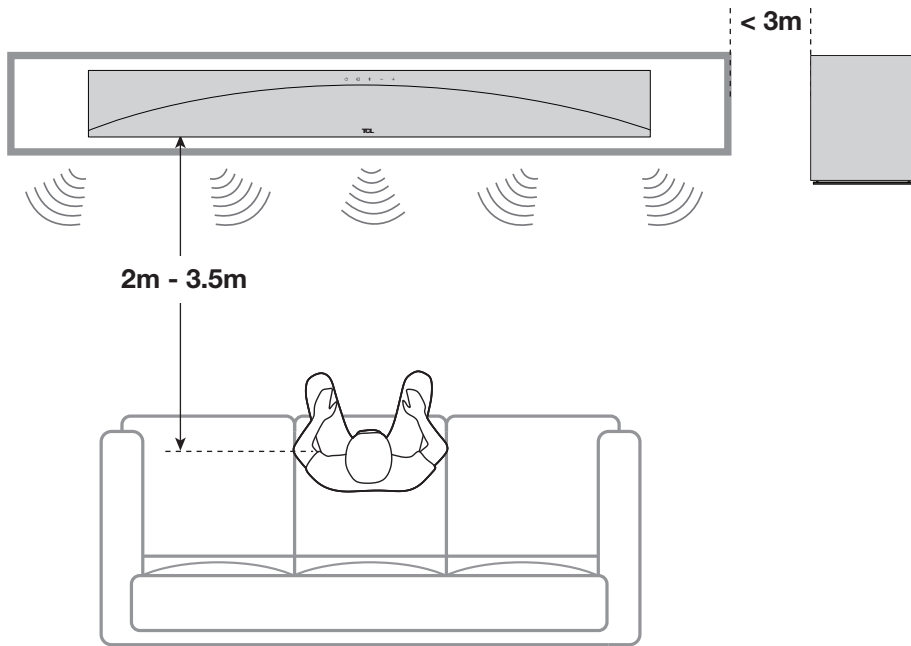

5a



1

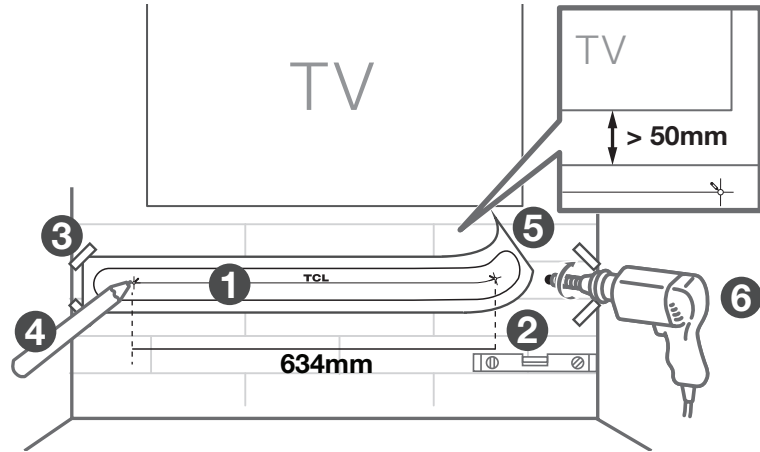
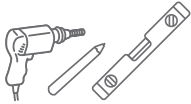
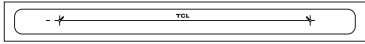

5b



E

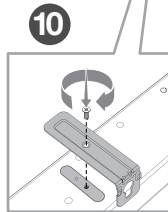
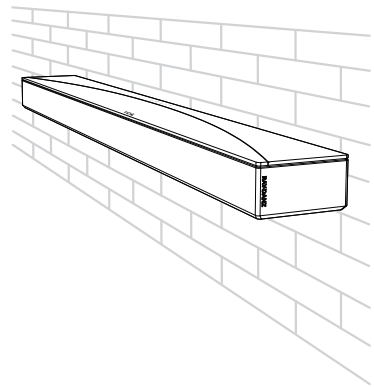
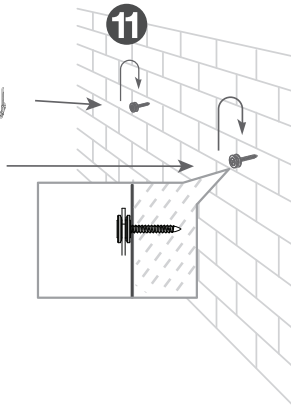
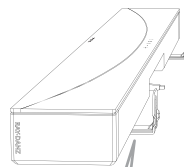
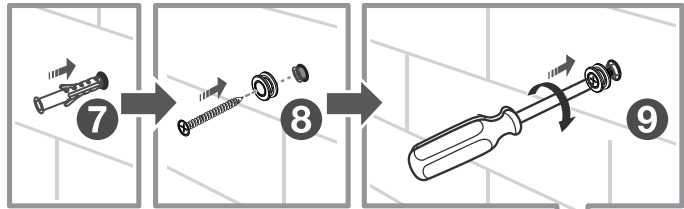
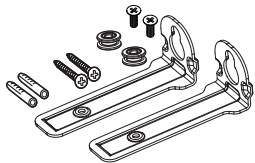

6



Battery type: 1.5V AAA battery x 2

D



Warning: Do not expose batteries to excessive heat such as sunshine, fire, or the like. Keep new and used batteries away from children. For disposal or recycling information, please contact your local authorities.



CAUTION: Danger of explosion if the battery is incorrectly replaced. Replace only with the same or equivalent type.

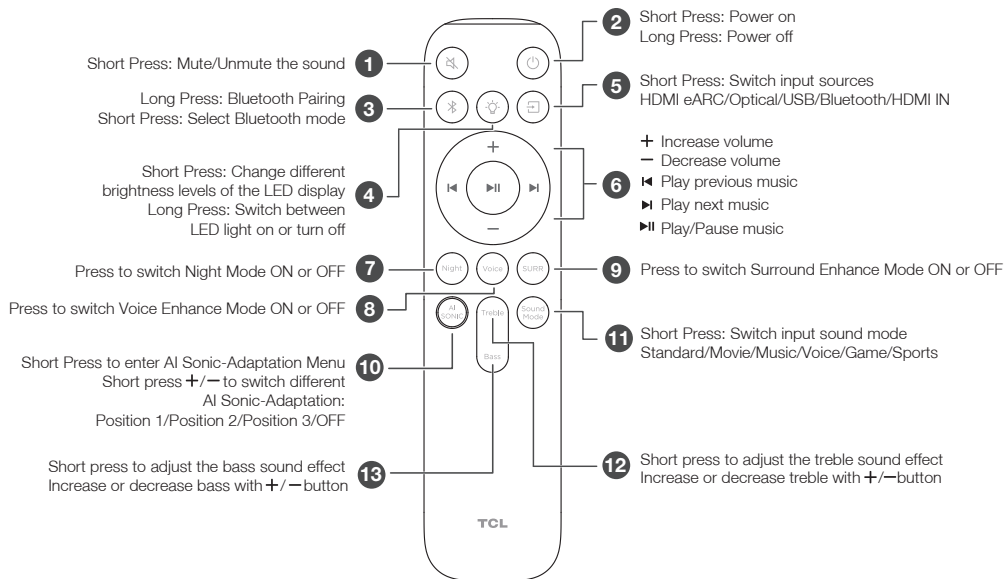
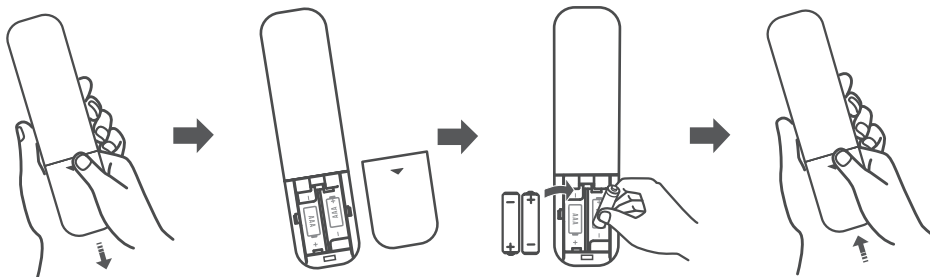

6



Loji i baterisë: 1,5V bateri AAA x 2

D



! Paralajmërim: Mos i ekspozoni bateritë ndaj nxehtësisë së tepërt si rrezet e diellit, zjarrit ose të ngjashme. Mbani bateritë e reja dhe të përdorura larg fëmijëve. Për informacion mbi asgjësimin ose riciklimin, ju lutemi kontaktoni autoritetet tuaja lokale.

! KUJDES: Rrezik shpërthimi nëse bateria është zëvendësuar gabimisht. Zëvendësoni vetëm me të njëjtin lloj ose ekuivalent.

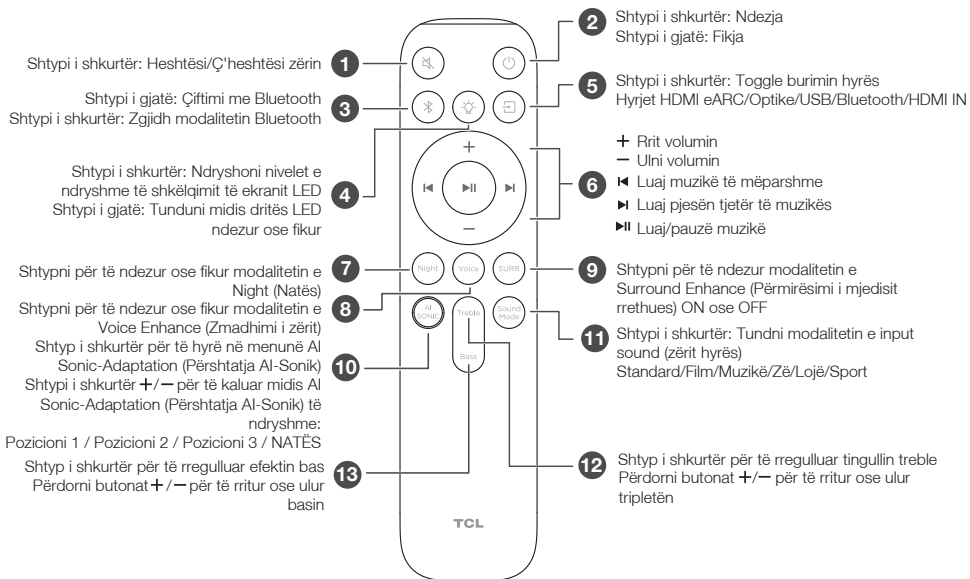
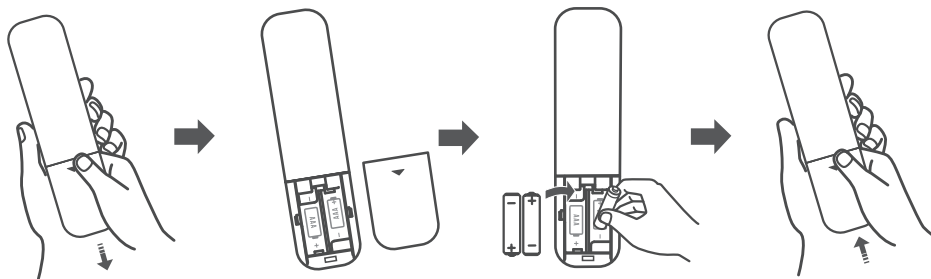



Тип батерия: 1,5 V AAA батерия x 2



! Предупреждение: Не излагайте батериите на прекомерна топлина, като слънчева светлина, огън или други подобни. Съхранявайте новите и използваните батерии далеч от деца. За информация за изхвърляне или рециклиране, моля, свържете се с местните власти.

! ВНИМАНИЕ: Опасност от експлозия, ако батерията бъде сменена неправилно. Сменяйте само със същия или еквивалентен тип.

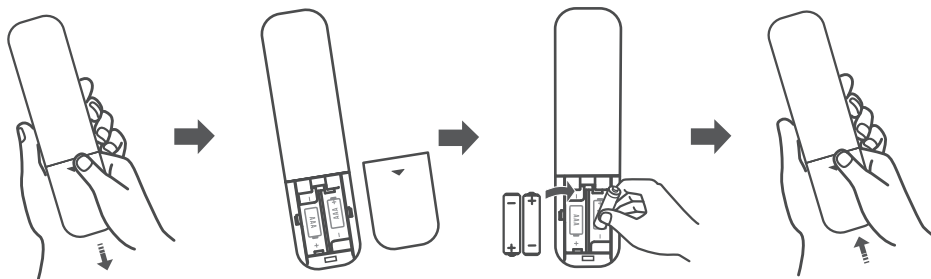

6



Vrsta baterije: 1,5 V AAA baterija x 2

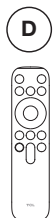

! Upozorenje: Ne izlažite baterije pretjeranoj toplini kao što je sunčeva svjetlost, vatra ili slično. Nove i iskorištene baterije držite podalje od djece. Za informacije o odlaganju ili recikliranju obratite se lokalnim vlastima.

! OPREZ: Opasnost od eksplozije ako se baterija neispravno zamijeni. Zamijenite samo istim ili ekvivalentnim tipom.

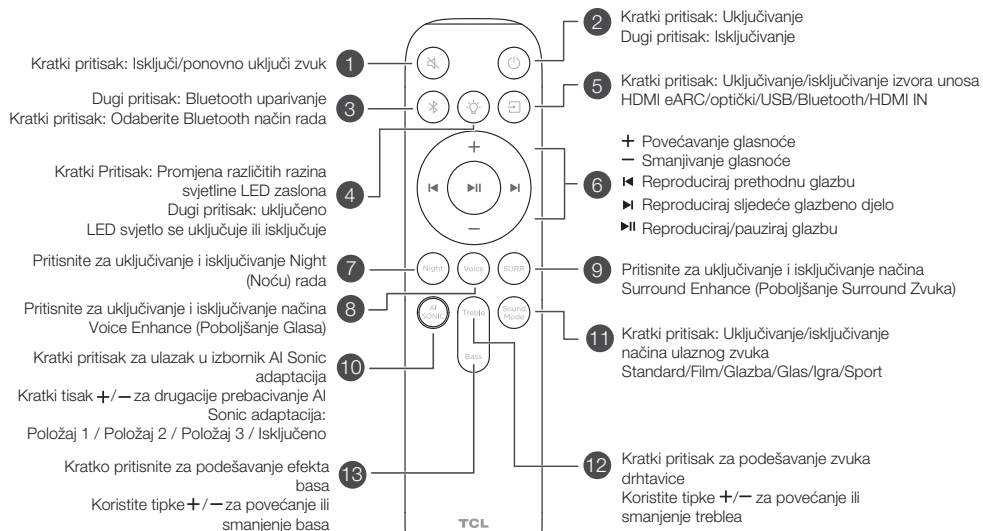
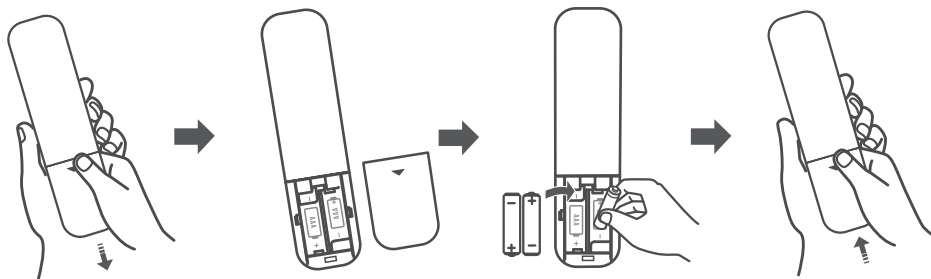

6



Typ baterie: 1,5V AAA baterie x 2

D



! Varování: Nevystavujte baterie nadměrnému teplu, jako je sluneční záření, oheň a podobně. Nové a použité baterie uchovávejte mimo dosah dětí. Informace o likvidaci nebo recyklaci vám poskytne místní úřad.

! POZOR: Při nesprávné výměně baterie hrozí nebezpečí výbuchu. Vyměňte pouze za stejný nebo ekvivalentní typ.

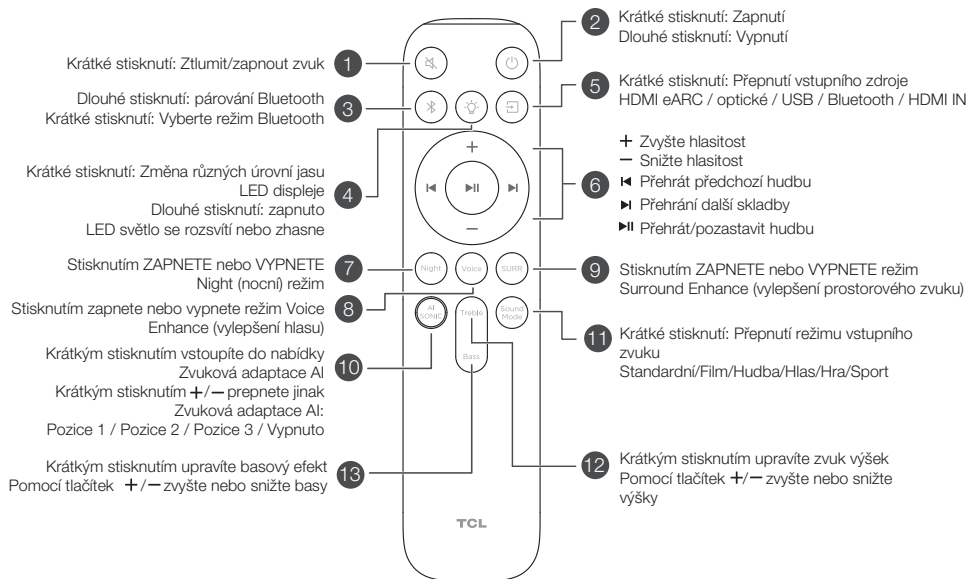
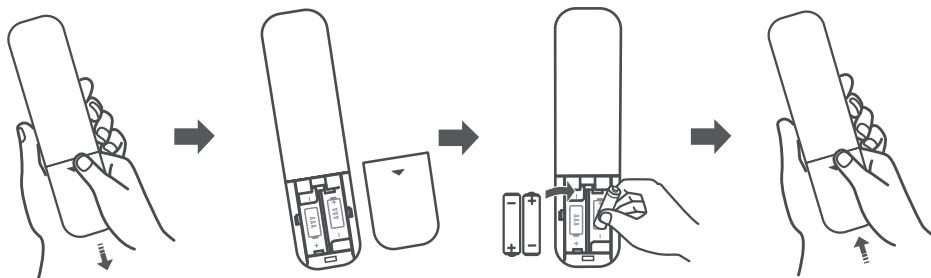

6



Batteritype: 1,5V AAA batteri x 2

D



Advarsel: Udsæt ikke batterier for høj varme såsom solskin, ild eller lignende. Hold nye og brugte batterier væk fra børn. For information om bortskaffelse eller genbrug, kontakt venligst de lokale myndigheder.



FORSIGTIG: Fare for eksplosion, hvis batteriet udskiftes forkert. Udskift kun med samme eller tilsvarende type.

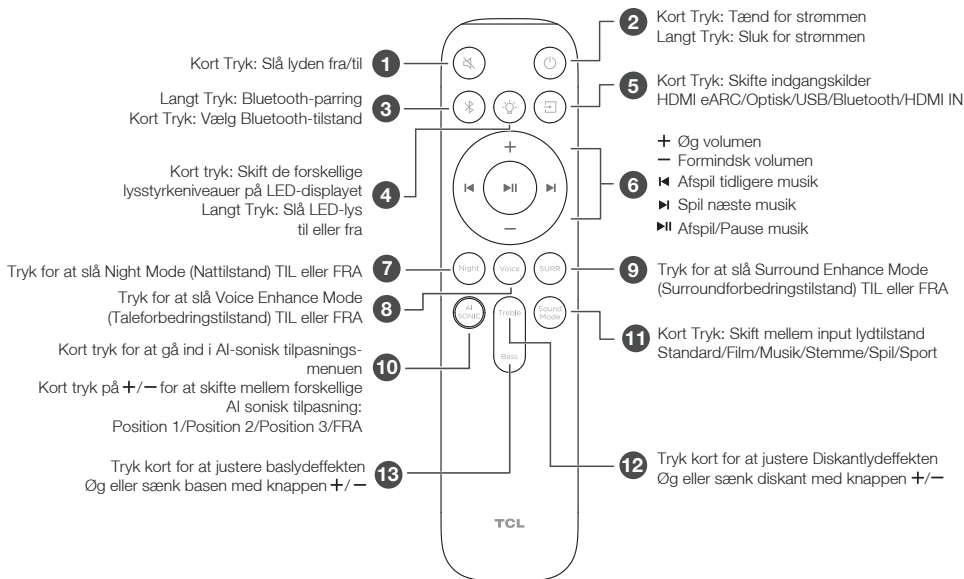
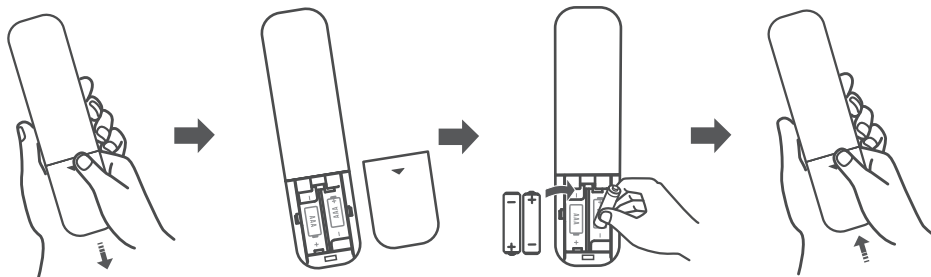

6



Batterijtype: 1,5 V AAA-batterij x 2

D



! Waarschuwing: Stel batterijen niet bloot aan overmatige hitte, zoals zonlicht, vuur en dergelijke. Houd nieuwe en gebruikte batterijen buiten het bereik van kinderen. Voor informatie over verwijdering of recycling kunt u contact opnemen met de plaatselijke autoriteiten.

! LET OP: Er bestaat explosiegevaar als de batterij onjuist wordt vervangen. Alleen vervangen door hetzelfde of gelijkwaardige type.

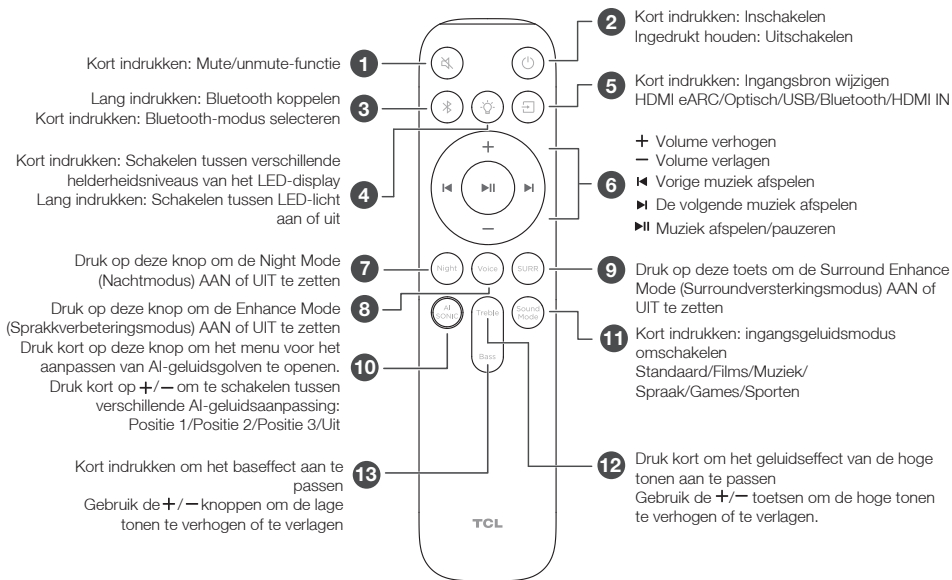
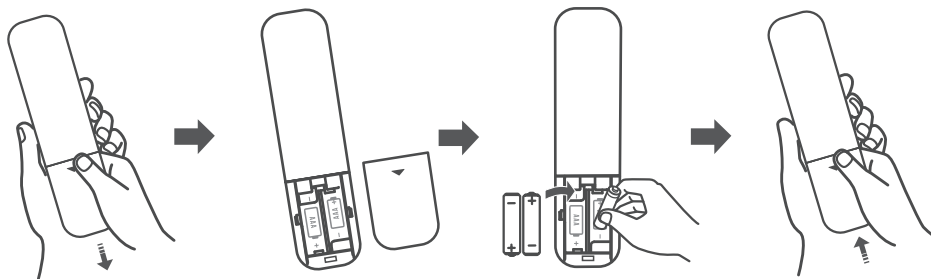

6



Aku tüüp: 1,5 V AAA aku x 2

D

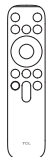

Hoiatus: Ärge jätke akusid liigse kuumuse (nt päikesevalguse, tule või muu sarnase) kätte. Hoidke uued ja kasutatud patareid lastele kättesaamatus kohas. Utiliseerimise või ringlussevõtu teabe saamiseks võtke ühendust kohalike ametiasutustega.



ETTEVAATUST: Aku valesti vahetamisel tekib plahvatusoht. Asendage ainult sama või samavärset tüüpi.

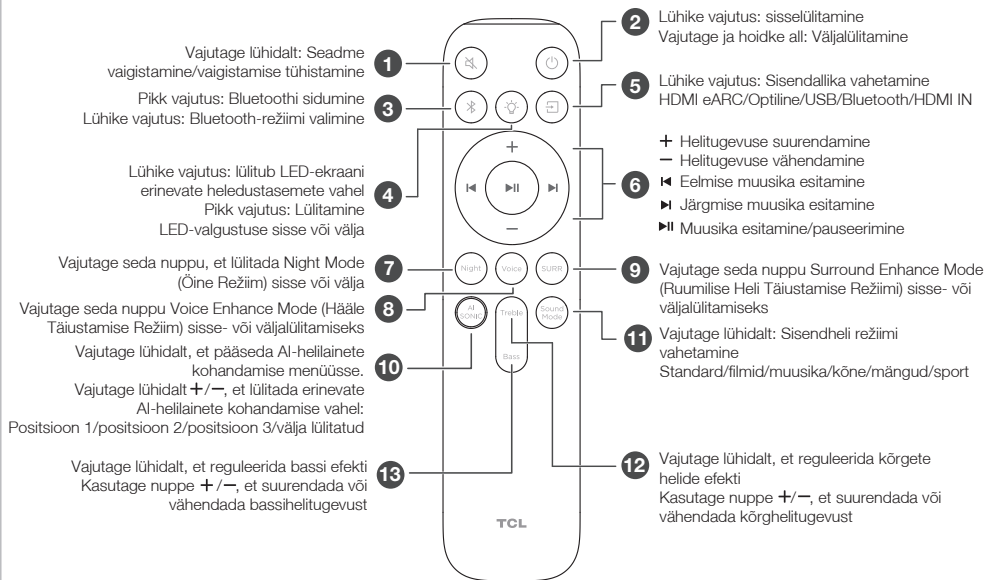
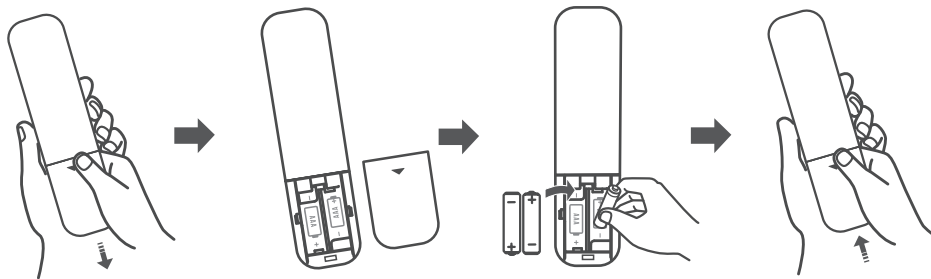

6



Paristotyyppi: 1,5V AAA-paristo x 2

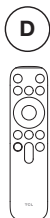

! Varoitus: Älä altista akkuja liialliselle kuumuudelle, kuten auringonpaisteelle, tulelle tai vastaavalle. Pidä uudet ja käytetyt paristot poissa lasten ulottuvilta. Ota yhteyttä paikallisiin viranomaisiin saadaksesi tietoja hävittämisestä tai kierrätyksestä.

! VAROITUS: Räjähdyksivaara, jos akku vaihdetaan väärin. Vaihda vain samaan tai vastaavaan tyyppiin.

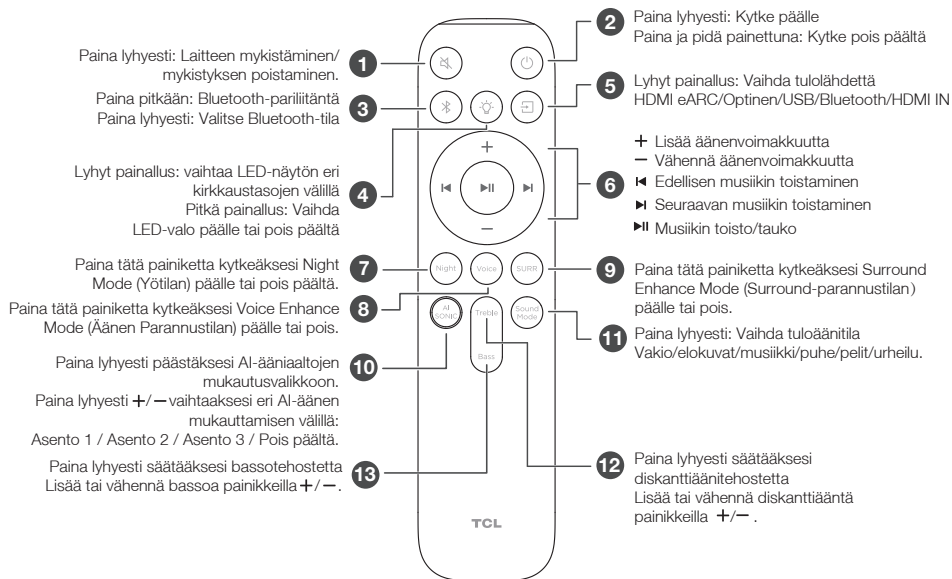
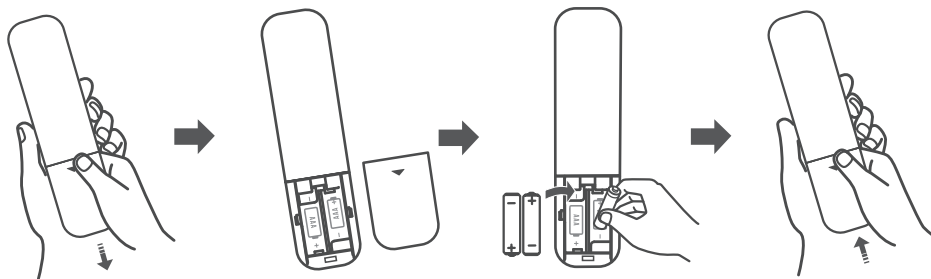

6



Type de batterie : Batterie AAA 1,5V x 2

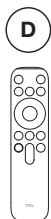

! Avertissement : N'exposez pas les batteries à une chaleur excessive, tel que le soleil, le feu, etc. Gardez les batteries neuves et usagées hors de portée des enfants. Pour obtenir des informations sur l'élimination ou le recyclage, veuillez contacter les autorités locales.

! ATTENTION : Risque d'explosion si la batterie n'est pas correctement remplacée. Remplacez uniquement par le même type ou un type équivalent.

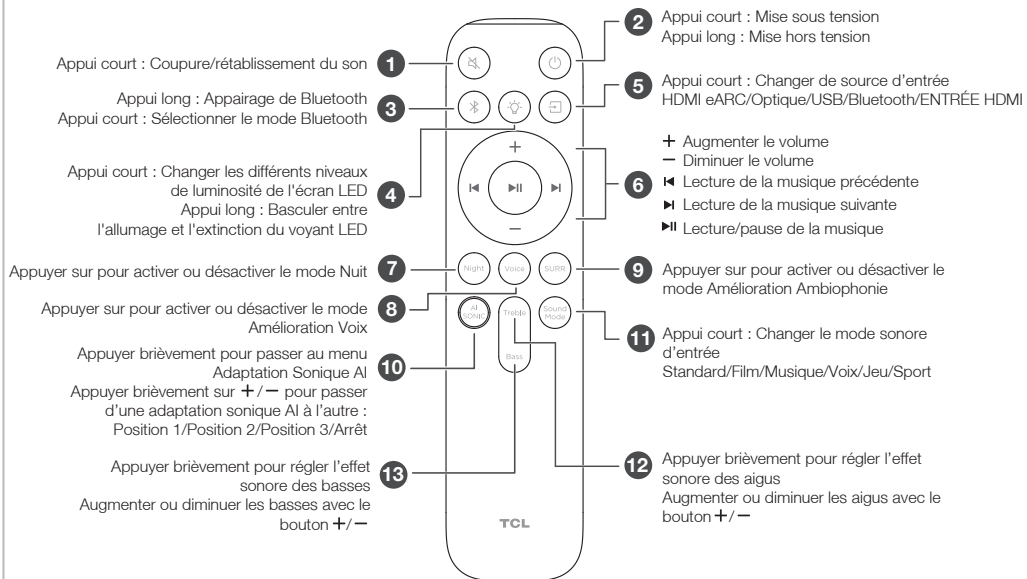
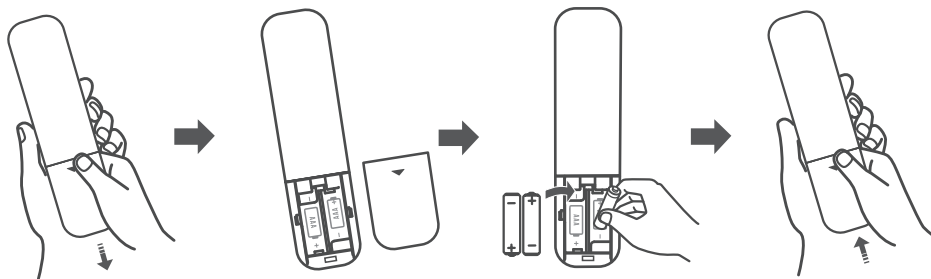

6



Batterietyp: 1,5V AAA-Batterie x 2

D



! Warnhinweis: Setzen Sie die Batterien nicht übermäßiger Hitze wie Sonnenschein, Feuer oder Ähnlichem aus. Halten Sie neue und gebrauchte Batterien von Kindern fern. Für Informationen zur Entsorgung oder zum Recycling wenden Sie sich bitte an Ihre örtlichen Behörden.

! ACHTUNG: Es besteht Explosionsgefahr, wenn die Batterie falsch ersetzt wird. Ersetzen Sie sie nur durch denselben oder einen gleichwertigen Typ.

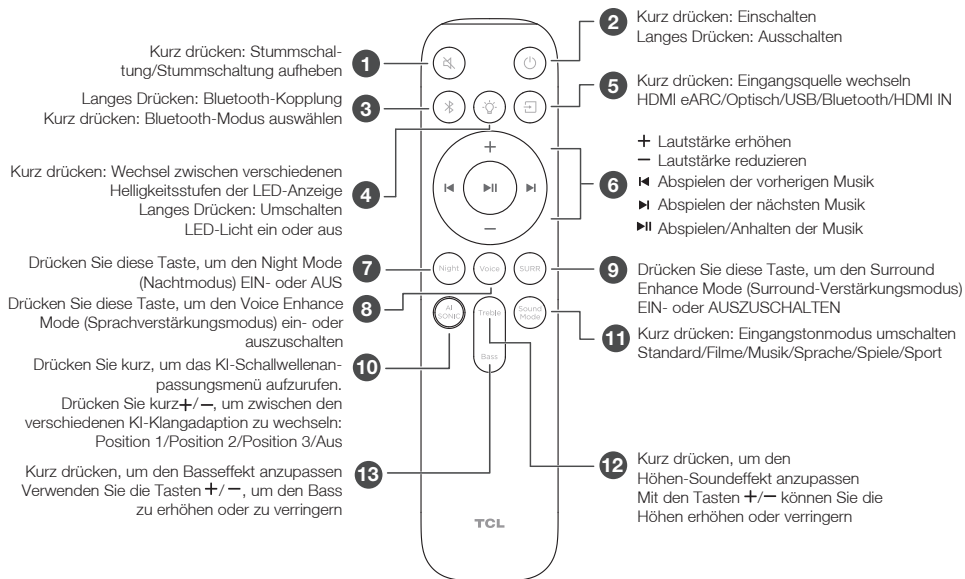
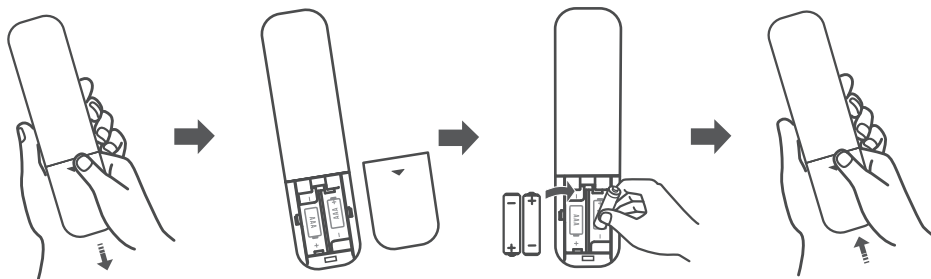

6



Τύπος μπαταρίας: Μπαταρία 1,5V AAA x 2

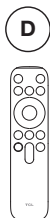

! Προειδοποίηση: Μην εκθέτετε τις μπαταρίες σε υπερβολική θερμότητα όπως ηλιοφάνεια, φωτιά ή κάτι παρόμοιο. Κρατήστε τις καινούριες και τις χρησιμοποιημένες μπαταρίες μακριά από παιδιά. Για πληροφορίες απόρριψης ή ανακύκλωσης, επικοινωνήστε με τις τοπικές αρχές.

! ΠΡΟΣΟΧΗ: Κίνδυνος έκρηξης εάν η μπαταρία δεν αντικατασταθεί σωστά. Αντικαταστήστε μόνο με τον ίδιο ή ισοδύναμο τύπο.

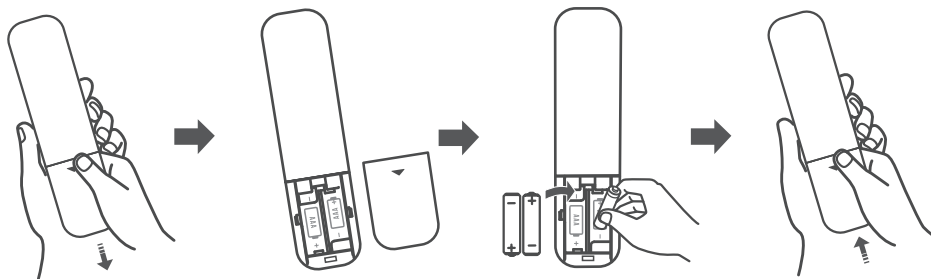

Σύντομος Τύπος: Σίγαση/κατάργηση σίγασης

Μακρύς Τύπος: Σύζευξη Bluetooth

Σύντομος Τύπος: Επιλέξτε λειτουργία Bluetooth

Σύντομο πάτημα: Αλλάξετε τα διαφορετικά επίπεδα φωτεινότητας της οθόνης LED

Μακρύς Τύπος: Ενεργοποιήστε ή απενεργοποιήστε τη λυχνία LED

Πατήστε για να ενεργοποιήσετε ή να απενεργοποιήσετε τη Night (Νυχτερινή) λειτουργία

Πατήστε για να ενεργοποιήσετε ή να απενεργοποιήσετε τη λειτουργία Voice Enhance (Βελτίωσης ομιλίας)

Σύντομο πάτημα για εισαγωγή στο μενού AI Sonic-Adaption

Σύντομο πάτημα + / - για να αλλάξετε διαφορετική AI Sonic Adaption: Θέση 1/Θέση 2/Θέση 3/Απενεργοποίηση

Πατήστε σύντομα για να ρυθμίσετε το ηχητικό εφέ μπάσων

Αυξήστε ή μειώστε το μπάσο με το κουμπί + / -

2 Σύντομος Τύπος: Ενεργοποίηση Μακρύς Τύπος: Απενεργοποίηση

5 Σύντομος Τύπος: Εναλλαγή πηγών εισόδου HDMI eARC/Οπτικός/USB/Bluetooth/ΕΙΣΟΔΟΣ HDMI

+ Αύξηση του όγκου
- Μείωση του όγκου

6 ◀ Παίξτε προηγούμενη μουσική
▶ Παίξτε την επόμενη μουσική
▶▶ Αναπαραγωγή/Παύση μουσικής

9 Πατήστε για να ενεργοποιήσετε ή να απενεργοποιήσετε τη λειτουργία βελτίωσης Surround Enhance (Νισχύστε Περιβάλλον)

11 Σύντομος Τύπος: Αλλαγή λειτουργίας ήχου εισόδου Πρότυπο/Ταινίες/Μουσική/Φωνή/Παιχνίδια/Αθλητισμός

12 Πατήστε σύντομα για να εισέλθετε στο ηχητικό εφέ των τριμών

Αύξηση ή μείωση των τριμών με το κουμπί + / -

6



Elem típusa: 1,5V AAA elem x 2

D

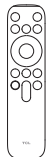

! Figyelmeztetés: Ne tegye ki az elemeket túlzott hőhatásnak, például napsütésnek, tűznek vagy hasonlóknak. Az új és a használt elemeket tartsa távol a gyermekektől. Az ártalmatlanítással vagy az újrahasznosítással kapcsolatos információkért forduljon a helyi hatóságokhoz.

! VIGYÁZAT: Az akkumulátor helytelen cseréje robbanásveszélyes. Csak azonos vagy azzal egyenértékű típusra cserélje ki.

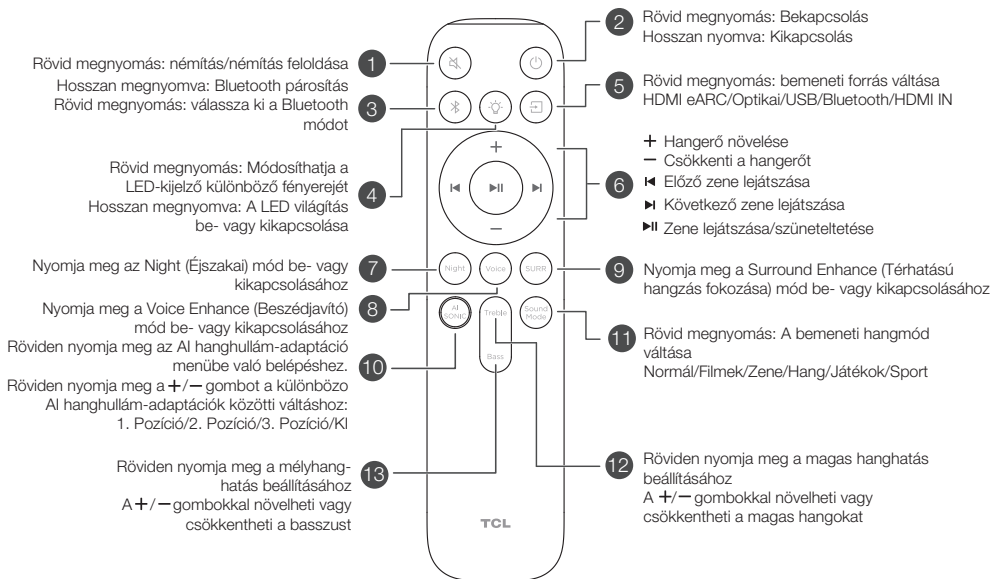
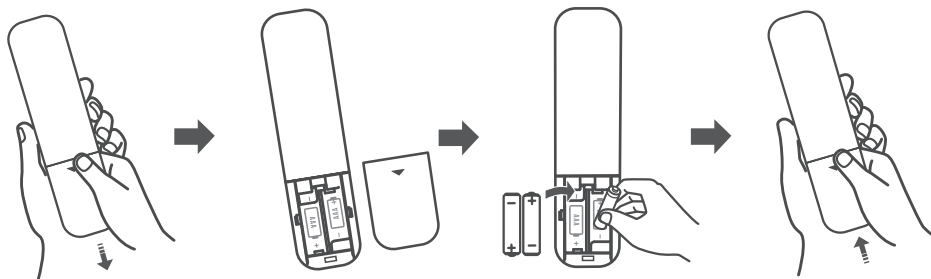

6



Tipo di batteria: Batteria AAA da 1,5V x2

D



! Attenzione: non esporre le batterie a calore eccessivo, ad esempio al sole, al fuoco o simili. Tenere le batterie nuove e usate lontano dalla portata dei bambini. Per informazioni sullo smaltimento o il riciclaggio, la preghiamo di contattare le autorità locali.

! ATTENZIONE: pericolo di esplosione se la batteria viene sostituita in modo errato. Sostituire solo con batterie dello stesso tipo o equivalenti.

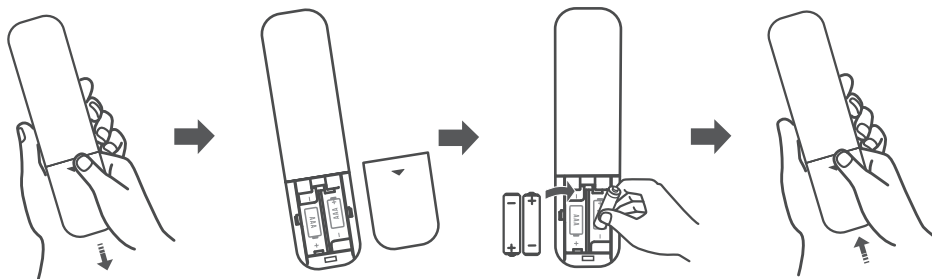

Premere brevemente: Disattivare/riattivare l'audio
 Premere a lungo: Associazione Bluetooth
 Premere brevemente: Selezionare la modalità Bluetooth

Pressione breve: consente di modificare i diversi livelli di luminosità del display a LED
 Premere a lungo: Accensione o spegnimento della luce LED

Premere per ATTIVARE o DISATTIVARE la modalità Night (Notturna)
 Premere per ATTIVARE o DISATTIVARE la modalità Voice Enhance (Miglioramento della voce)
 Premere brevemente per accedere al menu Adattamento sonoro AI
 Premere brevemente +/- per cambiare l'adattamento sonoro AI:
 Posizione 1/Posizione 2/Posizione 3/ DISATTIVARE

Premere brevemente per regolare l'effetto sonoro dei bassi
 Aumentare o diminuire i bassi con il pulsante +/-

1 [Mute] [Power]

2 Premere brevemente: Accensione
 Premere a lungo: Spegnimento

3 [Bluetooth] [Light] [HDMI]

5 Premere brevemente: Commutazione delle sorgenti di ingresso
 HDMI eARC/Ottica/USB/Bluetooth/HDMI IN

4 [Volume +] [Volume -] [Previous] [Next]

6 + Aumenta il volume
 - Diminuire il volume
 ◀ Riproduzione della musica precedente
 ▶ Riproduzione della musica successiva
 || Riproduzione/Pausa della musica

7 [Night] [Voice] [Game]

9 Premere per ATTIVARE o DISATTIVARE la modalità Surround Enhance (Miglioramento surround)

8 [AI Sound] [Tweeter] [Bass]

11 Premere brevemente: Commutare la modalità audio in ingresso
 Standard/Film/Musica/Voce/Gioco/Sport

10 [AI Sound] [Tweeter] [Bass]

12 Premere brevemente per regolare l'effetto sonoro degli acuti
 Aumentare o diminuire gli acuti con il pulsante +/-

13 [Bass]

TCL

6



Baterijas veids: 1,5 V AAA akumulators x 2

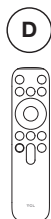

Brīdinājums: nepakļaujiet akumulatorus pārmērīgam karstumam, piemēram, saules stariem, ugunij vai tamīdizīgiem apstākļiem. Glabājiet jaunas un lietotas baterijas bērniem nepieejamā vietā. Lai iegūtu informāciju par utilizāciju vai pārstrādi, lūdzu, sazinieties ar vietējām iestādēm.



UZMANĪBU: Ja akumulators tiek nepareizi nomainīts, pastāv sprādziena risks. Nomainiet tikai ar tādu pašu vai līdzvērtīgu tipu.

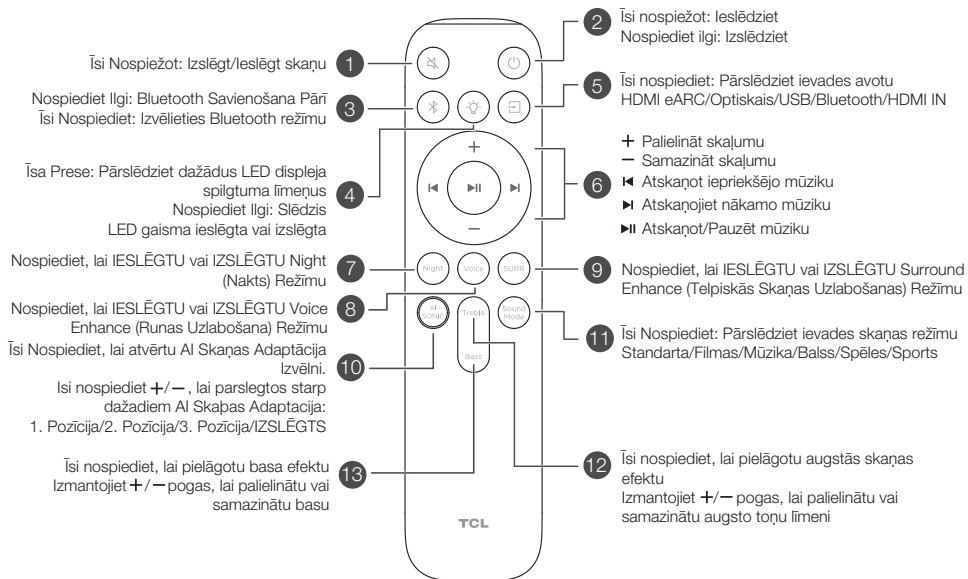
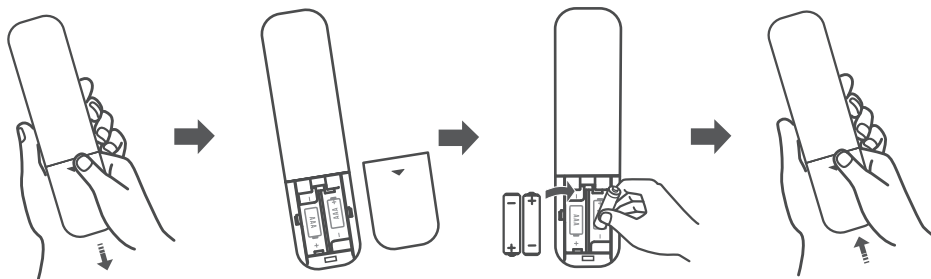

6



Baterijos tipas: 1,5 V AAA baterija x 2

D



⚠️ Įspėjimas: nelaikykite baterijų nuo per didelio karščio, pvz., saulės spindulių, ugnies ar pan. Naujas ir naudotas baterijas laikykite vaikams nepasiekiamoje vietoje. Norėdami gauti informacijos apie šalinimą arba perdirbimą, kreipkitės į vietos valdžios institucijas.

⚠️ **ATSARGIAI:** Netinkamai pakeitus bateriją, kyla sprogimo pavojus. Pakeiskite tik to paties arba lygiavertį tipo.

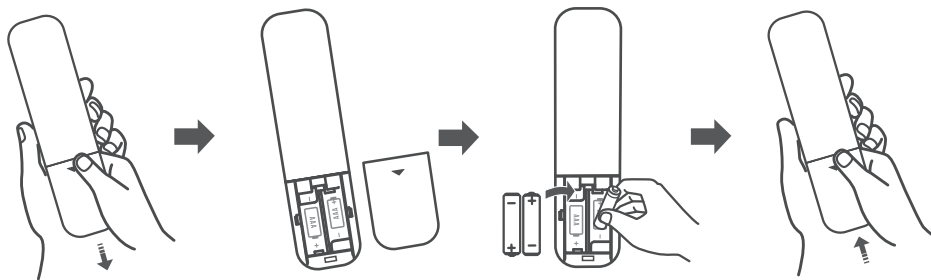

Trumpas paspaudimas: Nutildyti / Įjungti garsą

Ilgas paspaudimas: Bluetooth Susiejimas
Trumpas paspaudimas: Pasirinkite Bluetooth režimą

Trumpa Spauda: Keiskite skirtingus LED ekrano ryškumo lygius
Ilgas paspaudimas: Jungiklis LED lemputė įjungiama arba išjungiama

Paspauskite, kad įjungtumėte arba išjungtumėte Night (Naktis) režimą

Paspauskite, kad įjungtumėte arba išjungtumėte Voice Enhance (Kalbos Stiprinimas) režimą

Trumpai paspauskite, kad įeitumėte į AI garso bangų pritaikymo meniu
Trumpasis paspaudimas +/- perjungia skirtingus AI Garso Adaptacija:
1 Padėtis / 2 Padėtis / 3 Padėtis / Išjungta

Trumpai paspauskite, kad sureguliuotumėte žemųjų dažnių efektą
Norėdami padidinti arba sumažinti žemusius dažnius, naudokite +/- mygtukus

2 Trumpas Paspaudimas: Įjungtas
Ilgas Paspaudimas: Išjungti

3

4

5 Trumpas Paspaudimas: Perjunkite įvesties šaltinį HDMI eARC/Optinis/USB/Bluetooth/HDMI IN

6 + Padidinti garsumą
- Sumažinti garsumą
⏪ Groti ankstesnę muziką
▶▶ Leisti kitą muziką
▶▶▶▶ Leisti/Pristabdyti muziką

7

8

9 Paspauskite, kad įjungtumėte arba išjungtumėte Surround Enhance (Erdivinio Garso Patobulinimas) režimą

10

11 Trumpas Paspaudimas: Perjunkite įvesties garso režimą Standartinis/Filmai/Muzika/Balsas/Žaidimai/Sportas

12 Trumpai paspauskite, kad sureguliuotumėte aukštų dažnių garso efektą
Naudokite +/- mygtukus, kad padidintumėte arba sumažintumėte aukštus garsus

13

6



Тип на батерија: 1,5V AAA батерија x 2

D

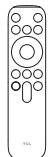

! Предупредување: Не изложувајте ги батериите на прекумерна топлина како што се сонце, оган или слично. Чувајте ги новите и користените батерии подалеку од деца. За информации за отстранување или рециклирање, ве молиме контактирајте со вашите локални власти.

! ВНИМАНИЕ: Опасност од експлозија доколку батеријата е неправилно заменета. Заменете само со ист или еквивалентен тип.

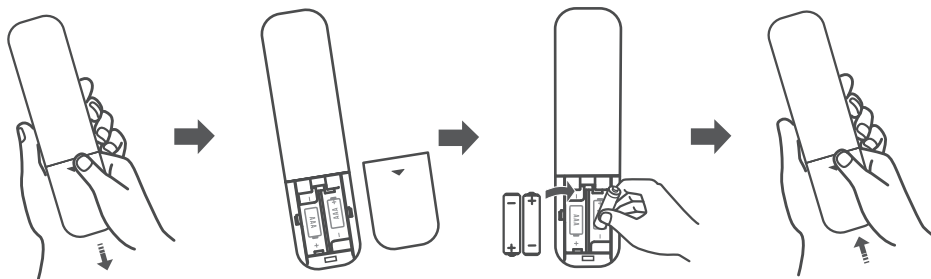

Кратко Притискање: Исклучување/Вклучи звук

Долго Притискање: Спарување со Bluetooth
Кратко Притискање: Изберете режим Bluetooth

Кратко Притискање: Променете ги различните нивоа на осветленост на LED дисплејот
Долго Притискање: Прекинувач Вклучено или исклучено LED светло
Притиснете за да го вклучите или исклучите Night (HoKe) режим
Притиснете за да го вклучите или исклучите режимот за Voice Enhance (Подобрување На Говорот)

Кратко Притиснете за да влезете во мениот за адаптација на звучни бранови со вештачка интелигенција

Кратко притиснете + / - за да се префрлате помеѓу различни Звучна Адаптација Со Вештачка Интелигенција:

Позиција 1/Позиција 2/Позиција 3/ИСКЛУЧЕНО
Кратко притиснете за да го прилагодите ефектот на бас

Користете ги копчињата + / - за да го зголемите или намалите басот



2 Кратко Притискање: Вклучување
Долго Притискање: Исклучи

5 Кратко Притискање: Сменете го влезниот извор HDMI eARC/Оптички/USB/Bluetooth/HDMI IN

+ Зголемете ја јачината на звукот
- Намалете ја јачината на звукот

6 ► Пуштете ја претходната музика

► Пушти ја следната музика

►► Репродуцирајте/Паузирајте музика

9 Притиснете за да го вклучите или исклучите режимот за Surround Enhance (Подобрување На Окружувачки Звук)

11 Кратко Притискање: префрлете го режимот за влезен звук
Стандарден/Филм/Музика/Глас/Игри/Спорт

12 Кратко притиснете за да го прилагодите звучниот ефект на високи тонови
Користете ги копчињата + / - за да ги зголемите или намалите високите тонови

6



Batteritype: 1,5V AAA-batteri x 2

D



Advarsel: Ikke utsett batterier for sterk varme som solskinn, ild eller lignende. Hold nye og brukte batterier unna barn. For informasjon om avhending eller resirkulering, vennligst kontakt lokale myndigheter.



FORSIKTIG: Fare for eksplosjon hvis batteriet skiftes ut på feil måte. Erstatt kun med samme eller tilsvarende type.

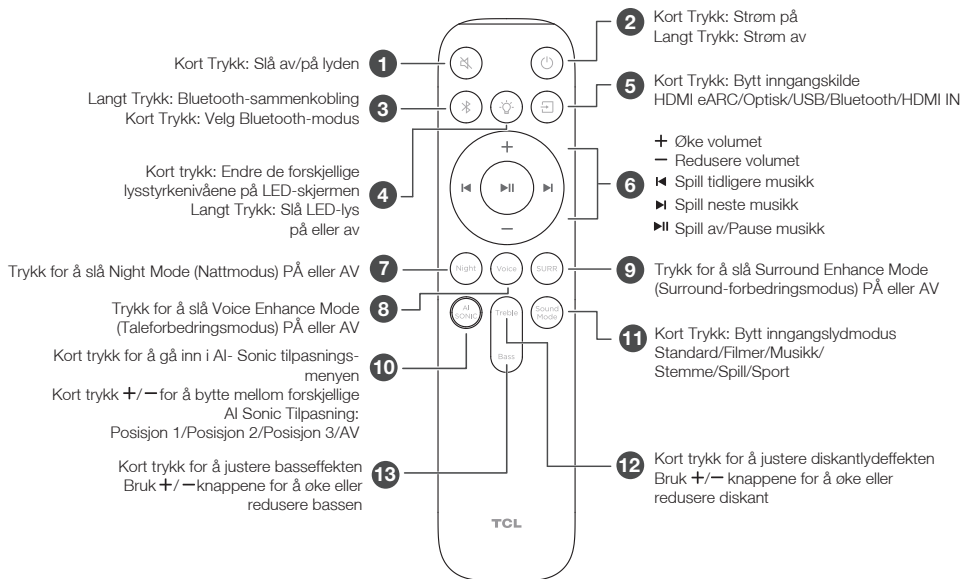
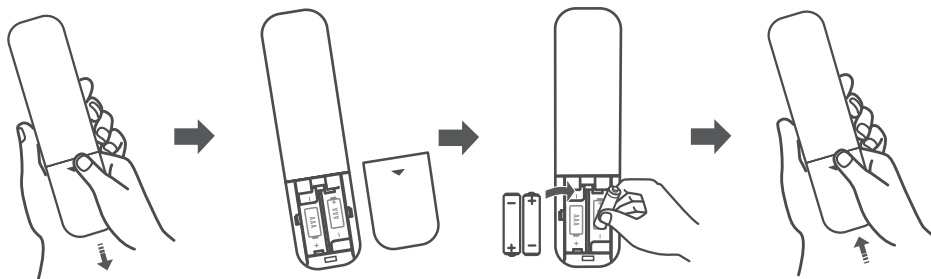



Typ baterii: bateria AAA 1,5 V x 2

D



! Ostrzeżenie: Nie należy wystawiać baterii na działanie nadmiernego ciepła, np. promieni słonecznych, ognia itp. Nowe i zużyte baterie należy umieścić poza zasięgiem dzieci. Aby uzyskać informacje na temat utylizacji lub recyklingu, należy skontaktować się z lokalnymi władzami.

! UWAGA: W przypadku nieprawidłowej wymiany baterii może dojść do wybuchu. Baterie należy wymienić na takie same lub ich odpowiedniki.

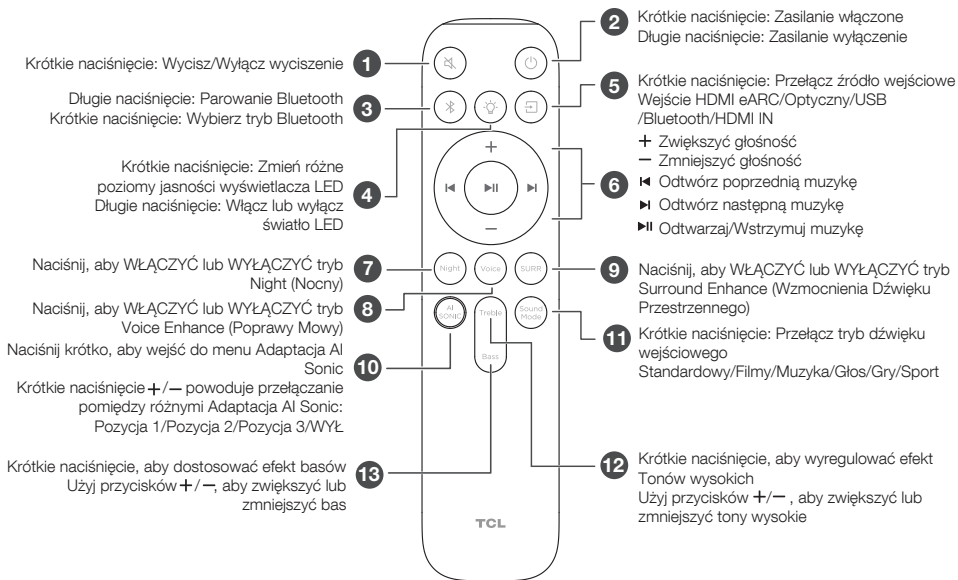
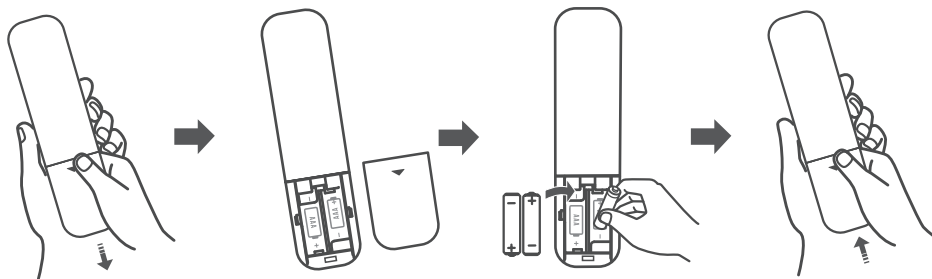

6



Tipo de bateria: Bateria AAA de 1,5V x 2

D



! Aviso: Não exponha as baterias a calor excessivo, como a luz solar, o fogo ou outros. Mantenha as baterias novas e usadas longe do alcance das crianças. Para obter mais informações sobre a eliminação ou a reciclagem, por favor, contate as autoridades locais.

! CUIDADO: Perigo de explosão se a bateria for substituída da forma incorreta. Substitua-a apenas por uma do mesmo tipo ou do tipo equivalente.

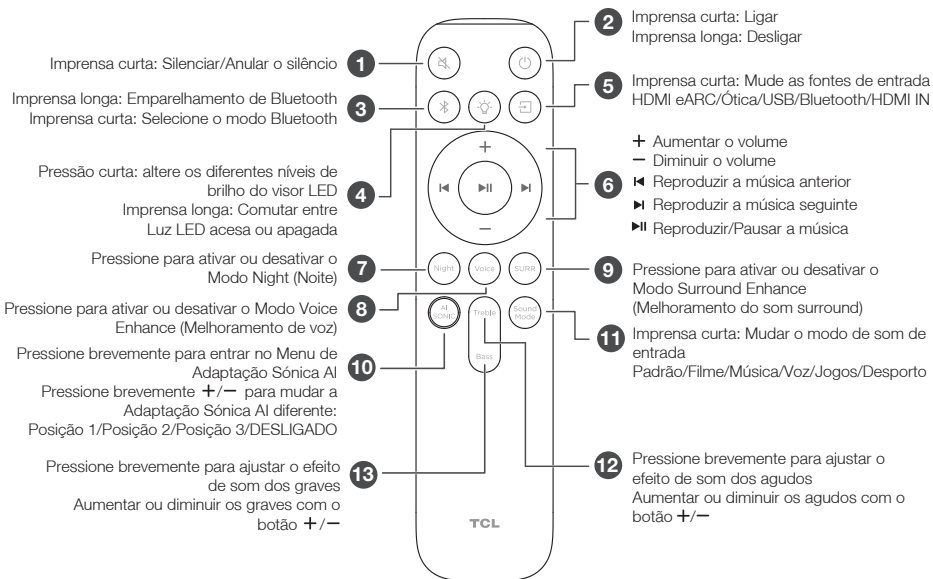
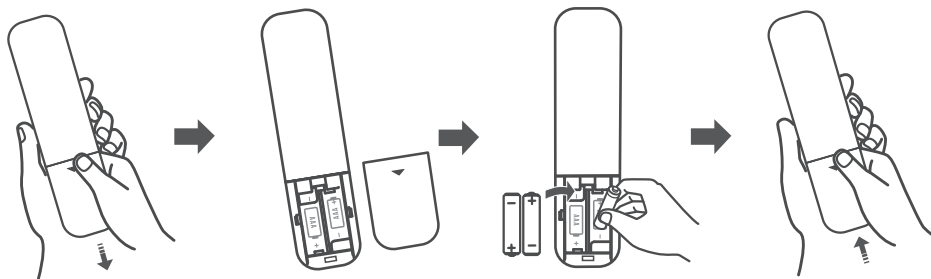



Tip baterie: baterie AAA de 1,5 V x 2

D

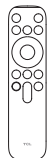

! Avertisment: Nu expuneți bateriile la căldură excesivă, cum ar fi soarele, focul sau altele asemenea. Păstrați bateriile noi și uzate departe de copii. Pentru informații despre eliminare sau reciclare, vă rugăm să contactați autoritățile locale.

! ATENȚIE: Pericol de explozie dacă bateria este înlocuită incorect. Înlocuiți numai cu același tip sau echivalent.

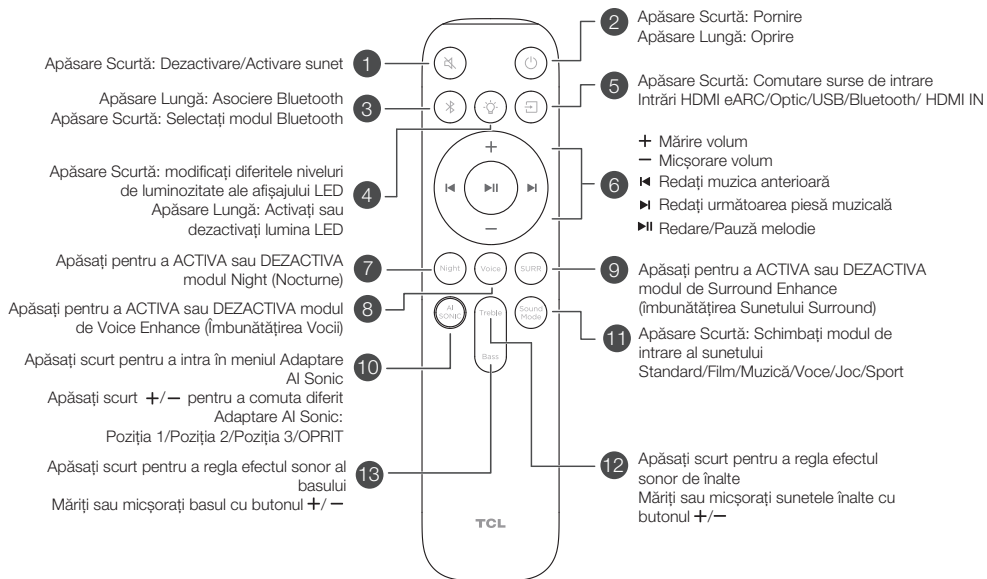
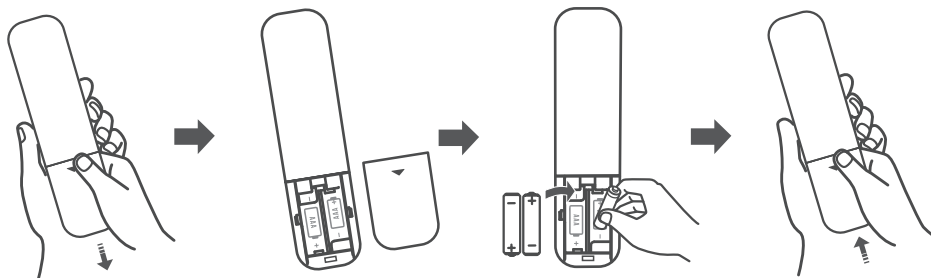

6



Тип батареи: 1,5 В батарея AAA x 2

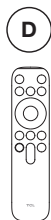

! Предупреждение: Не подвергайте элементы питания чрезмерному нагреву, например, солнечным лучам, огню или тому подобное. Храните новые и использованные элементы питания вдали от детей. Для получения информации об утилизации или переработке обратитесь в местные органы власти.

! ВНИМАНИЕ: Опасность возгорания при неправильной замене элементов питания. Заменяйте только на такие же или аналогичные.

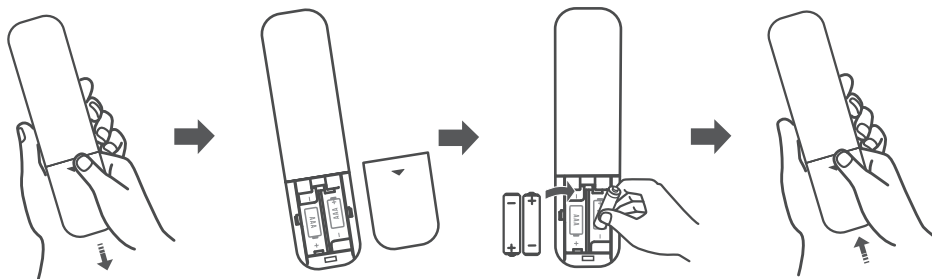



Tip baterije: 1,5V AAA baterija x 2

D



! Upozorenje: Ne izlažite baterije prekomernoj toploti kao što su sunce, vatra ili slično. Držite nove i iskorištene baterije dalje od dece. Za informacije o odlaganju ili reciklaži obratite se lokalnim vlastima.

! OPREZ: Opasnost od eksplozije ako je baterija nepravilno zamenjena. Zamenite samo istim ili ekvivalentnim tipom.

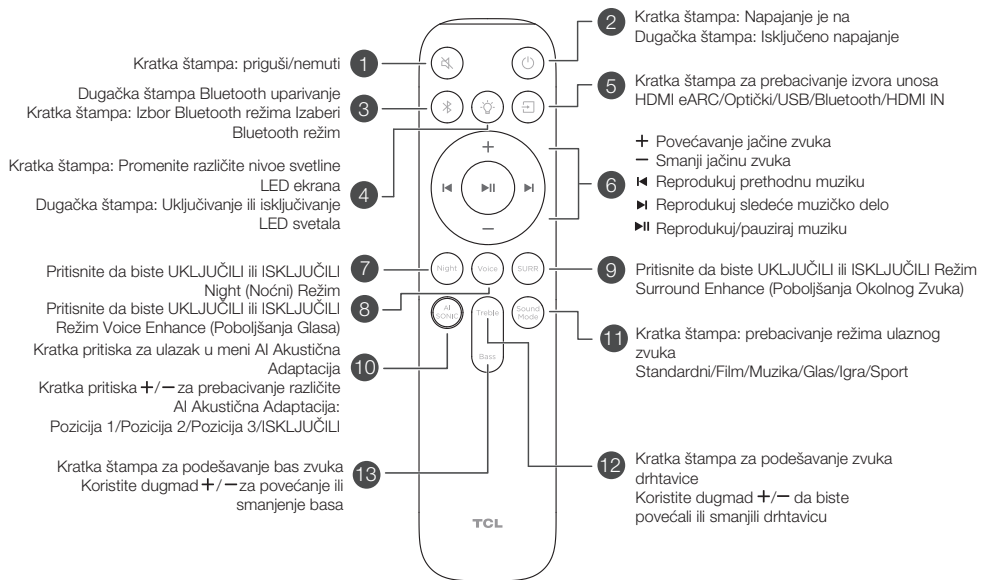
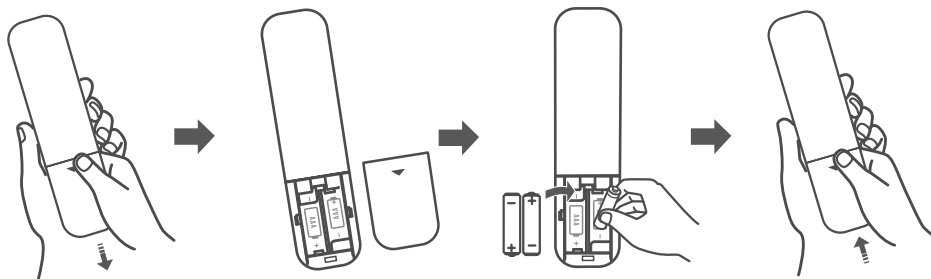

6



Typ batérie: 1,5V AAA batéria x 2

D



! Upozornenie: Nevystavujte batérie nadmernému teplu, ako je slnečné žiarenie, oheň a podobne. Nové a použité batérie uchovávajte mimo dosahu detí. Informácie o likvidácii alebo recyklácii získate od miestnych úradov.

! UPOZORNENIE: Pri nesprávnej výmene batérie hrozí nebezpečenstvo výbuchu. Vymeňte iba za rovnaký alebo ekvivalentný typ.

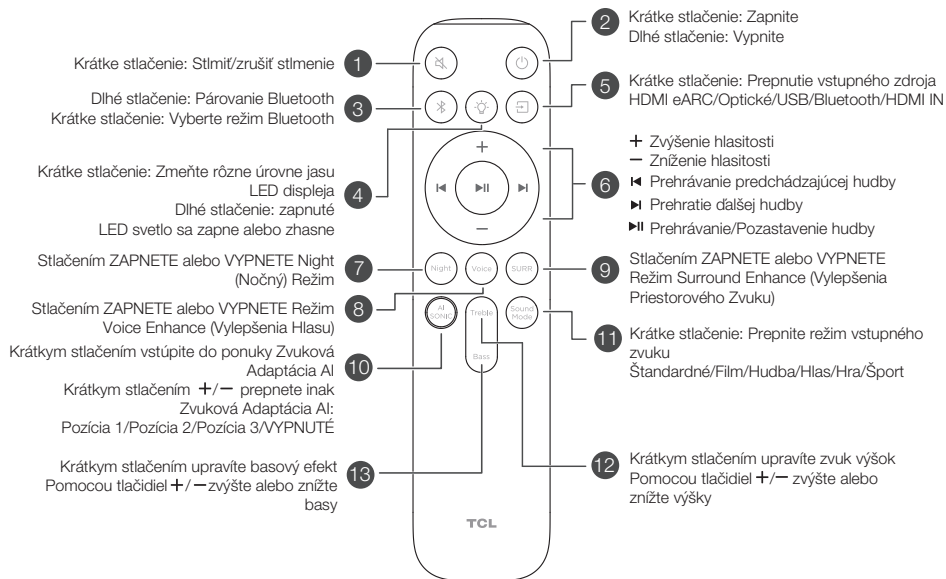
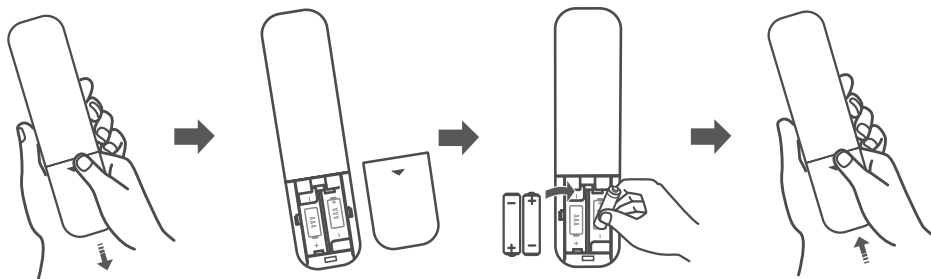

6



Vrsta baterije: 1,5 V AAA baterija x 2

D

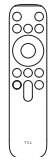

! Opozorilo: Baterij ne izpostavljajte prekomerni vročini, kot je sonce, ogenj ipd. Nove in rabljene baterije hranite izven dosega otrok. Za informacije o odlaganju ali recikliranju se obrnite na lokalne oblasti.

! POZOR: Nevarnost eksplozije, če baterijo ne zamenjate pravilno. Zamenjajte samo z enakim ali enakovrednim tipom.

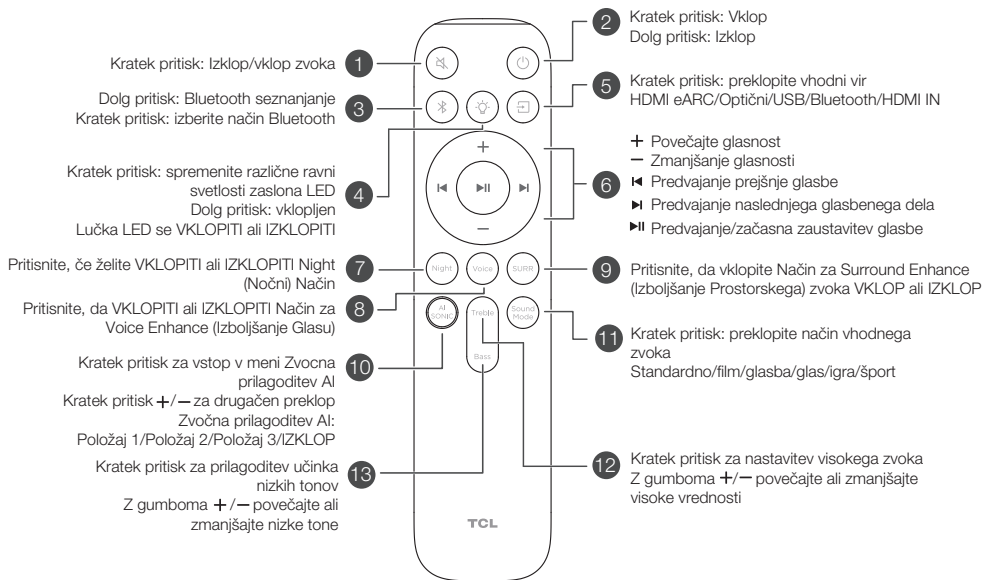
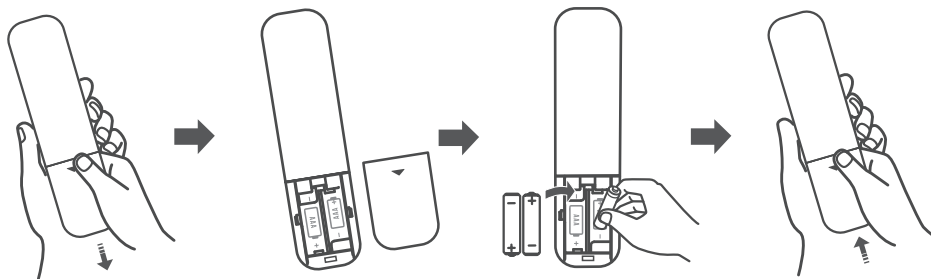

6



Tipo de batería: batería AAA de 1,5 V x 2

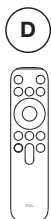

! Advertencia: No exponga las baterías al calor excesivo, como la luz del sol, el fuego o similares. Mantenga las baterías nuevas y usadas fuera del alcance de los niños. Para obtener información sobre cómo desechar o reciclar, comuníquese con las autoridades locales.

! PRECAUCIÓN: Peligro de explosión si la batería se reemplaza incorrectamente. Reemplace solo con el mismo tipo o equivalente.

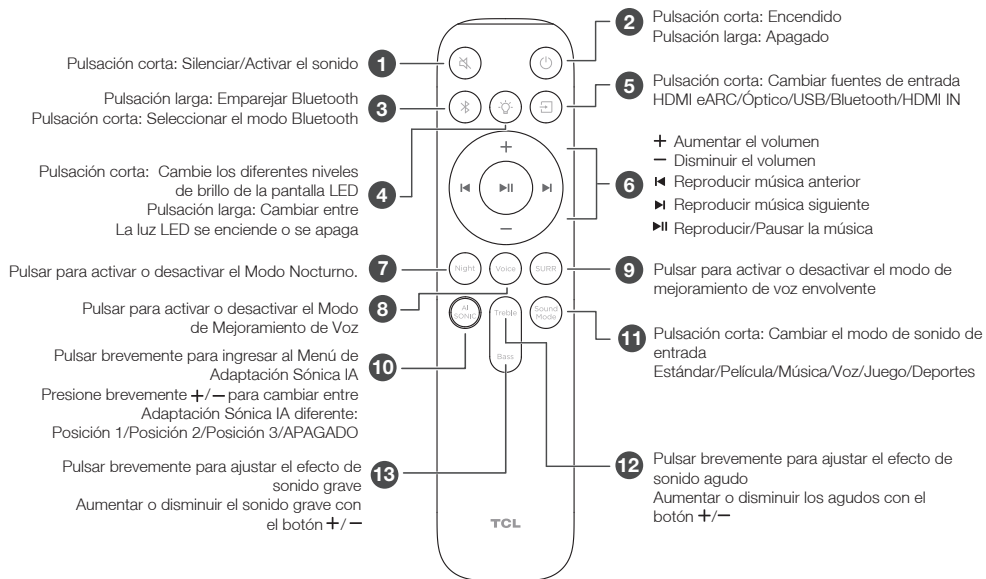
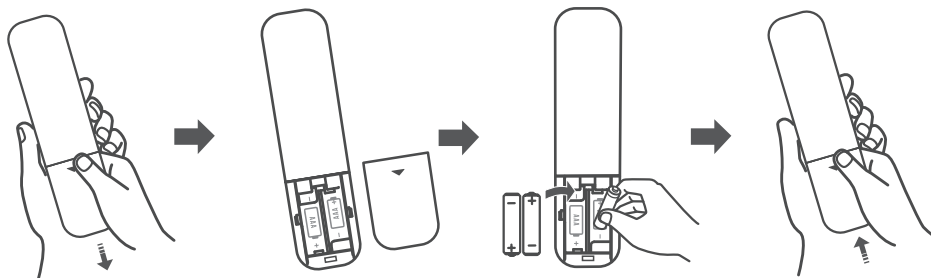

6



Batterityp: 1,5V AAA-batteri x 2

D



⚠ Varning: Utsätt inte batterier för stark värme som solsken, eld eller liknande. Håll nya och använda batterier borta från barn. Kontakta dina lokala myndigheter för information om avfallshantering eller återvinning.

⚠ VARNING: Risk för explosion om batteriet byts ut felaktigt. Ersätt endast med samma eller motsvarande typ.

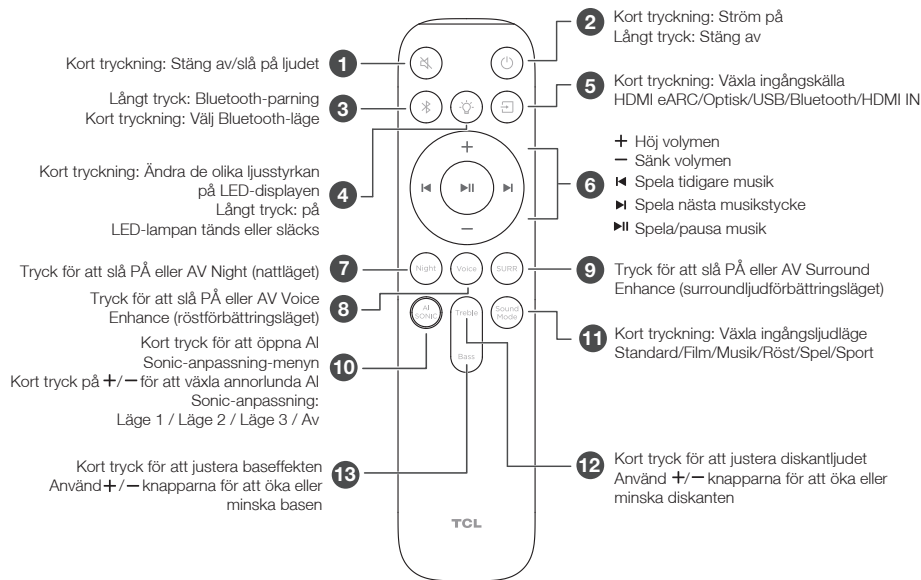
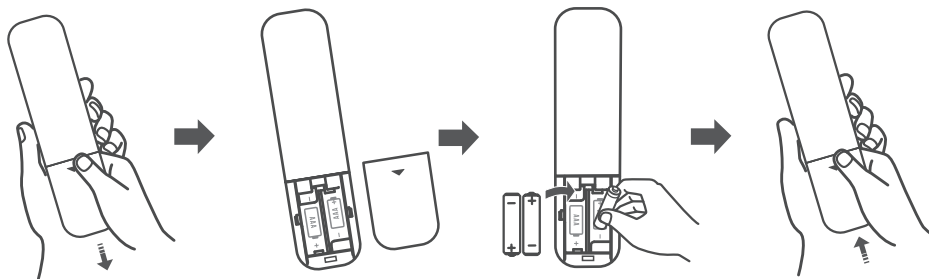

6



Pil tipi: 1,5V AAA pil x 2

D



⚠ Uyarı: Pilleri güneş ışığı, ateş veya benzeri aşırı ısıya maruz bırakmayın. Yeni ve kullanılmış pilleri çocuklardan uzak tutun. Bertaraf etme veya geri dönüştürme bilgileri için lütfen yerel yetkililerle iletişime geçin.

⚠ DİKKAT: Pilin yanlış değiştirilmesi durumunda patlama tehlikesi vardır. Yalnızca aynı veya eşdeğer türle değiştirin.

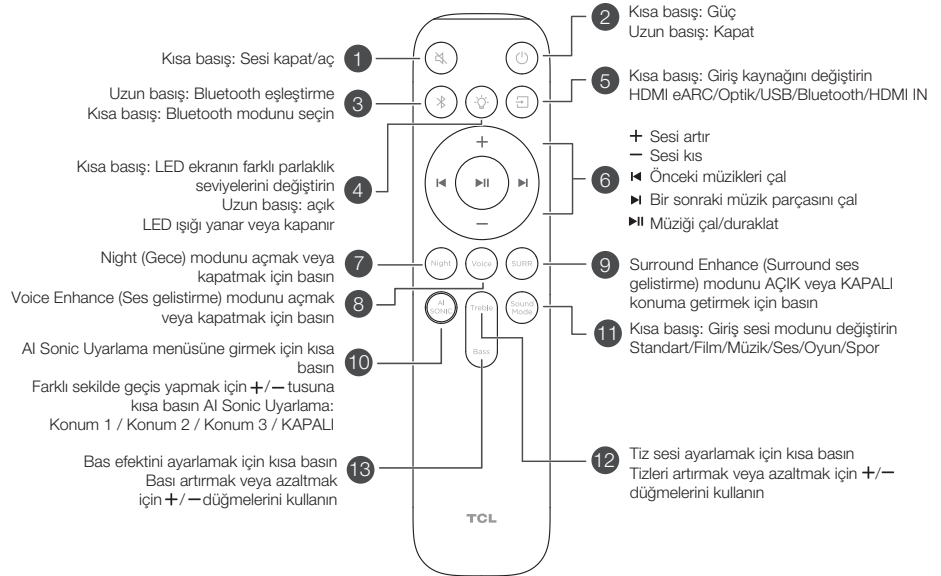
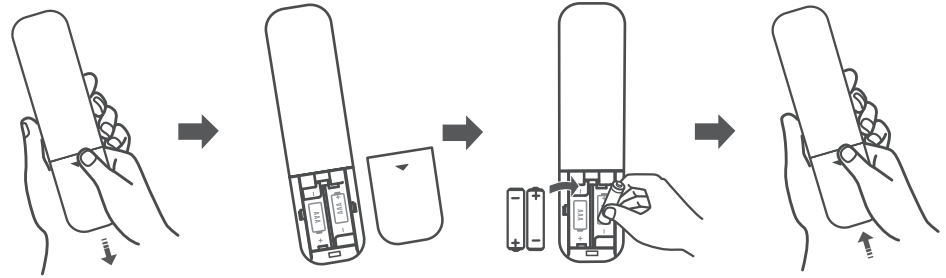

6



Тип батареї: 2 батареї типу AAA 1,5 В

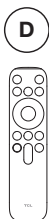

! Попередження: не піддавайте батареї впливу надмірного тепла, наприклад сонячного світла, вогню тощо. Тримайте нові та використані батареї подалі від дітей. Щоб отримати інформацію про утилізацію або переробку, зверніться до місцевих органів влади.

! УВАГА: небезпека вибуху, якщо батарею замінено неправильно. Замінійте лише на такий самий або еквівалентний тип.

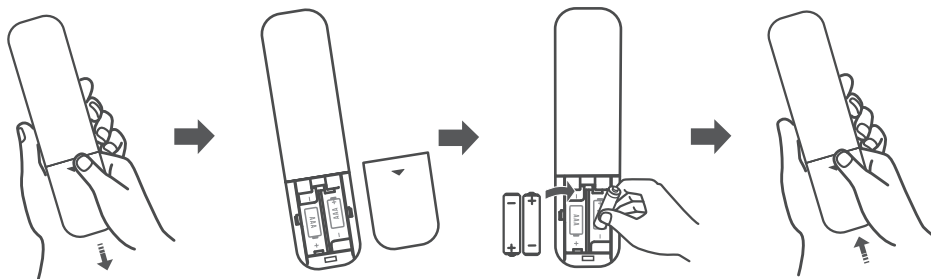

7a



EN This cable is sold separately.

SQ Ky kabëll shitet veçmas.

BG Този кабел се продава отделно.

HR Ovaj se kabel prodaje zasebno.

CZ Tento kabel se prodává samostatně.

DA Dette kabel sælges separat.

NL Deze kabel wordt apart verkocht.

ET Seda kaablit müüakse eraldi.

FI Kaapeli myydään erikseen.

FR Ce câble est vendu séparément.

DE Dieses Kabel wird separat verkauft.

EL Αυτό το καλώδιο πωλείται ξεχωριστά.

HU Ezt a kábelt külön értékesítik.

IT Questo cavo è venduto separatamente.

LV Šis kabelis tiek pārdots atsevišķi.

LT Šis kabelis parduodamas atskirai.

MK Овој кабел се продава одделно.

NO Denne kabelen selges separat.

PL Ten kabel jest sprzedawany osobno.

PT Este cabo é vendido separadamente.

RO Acest cablu este vândut separat.

RU Этот кабель продается отдельно.

SR Ovaj kabel se prodaje odvojeno.

SK Tento kábel sa predáva osobitne.

SL Ta kablo se prodaja ločeno.

ES Este cable se vende separadamente.

SV Denna kabel säljs separat.

TR Bu kablo ayrı satılır.

UA Цей кабель продається окремо.

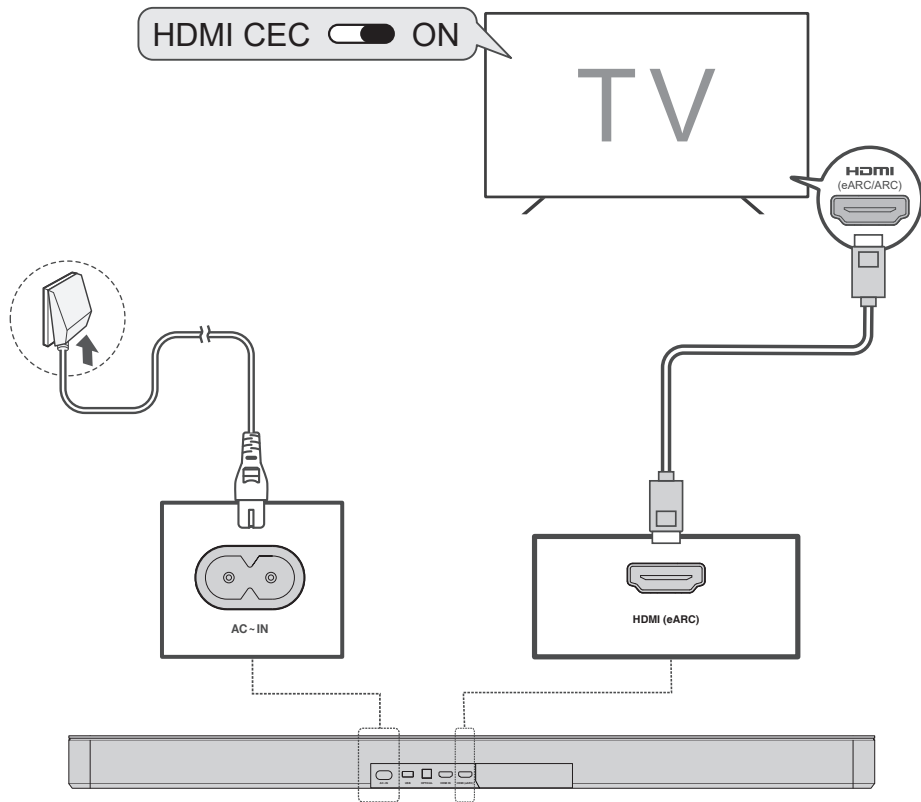

7a



EN This cable is sold separately.

SQ Ky kabëll shitet veçmas.

BG Този кабел се продава отделно.

HR Ovaj se kabel prodaje zasebno.

CZ Tento kabel se prodává samostatně.

DA Dette kabel sælges separat.

NL Deze kabel wordt apart verkocht.

ET Seda kaablit müüakse eraldi.

FI Kaapeli myydään erikseen.

FR Ce câble est vendu séparément.

DE Dieses Kabel wird separat verkauft.

EL Αυτό το καλώδιο πωλείται ξεχωριστά.

HU Ezt a kábelt külön értékesítik.

IT Questo cavo è venduto separatamente.

LV Šis kabelis tiek pārdots atsevišķi.

LT Šis kabelis parduodamas atskirai.

MK Овој кабел се продава одделно.

NO Denne kabelen selges separat.

PL Ten kabel jest sprzedawany osobno.

PT Este cabo é vendido separadamente.

RO Acest cablu este vândut separat.

RU Этот кабель продается отдельно.

SR Ovaj kabel se prodaje odvojeno.

SK Tento kábel sa predáva osobitne.

SL Ta kabel se prodaja ločeno.

ES Este cable se vende separadamente.

SV Denna kabel säljs separat.

TR Bu kablo ayrı satılır.

UA Цей кабель продається окремо.

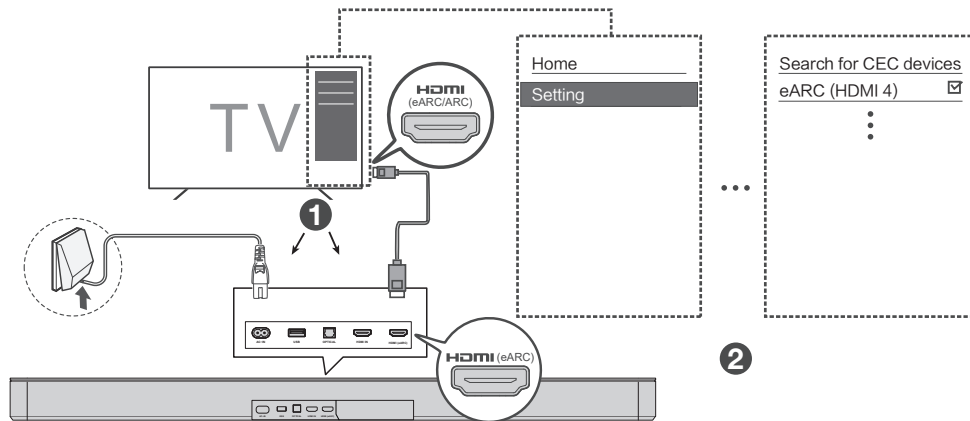
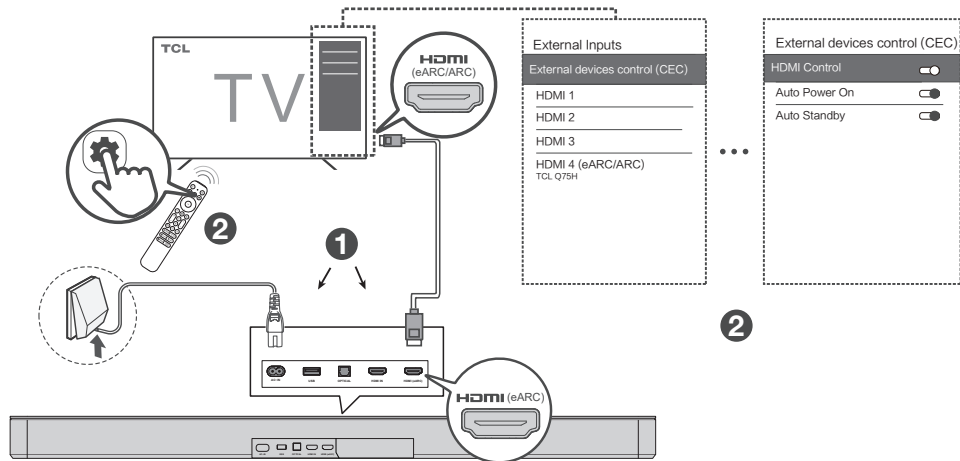

7b



- EN** This cable is sold seperately.
- SQ** Ky kabëll shitet veçmas.
- BG** Този кабел се продава отделно.
- HR** Ovaj se kabel prodaje zasebno.
- CZ** Tento kabel se prodává samostatně.
- DA** Dette kabel sælges separat.
- NL** Deze kabel wordt apart verkocht.
- ET** Seda kaablit müüakse eraldi.
- FI** Kaapeli myydään erikseen.
- FR** Ce câble est vendu séparément.
- DE** Dieses Kabel wird separat verkauft.
- EL** Αυτό το καλώδιο πωλείται ξεχωριστά.
- HU** Ezt a kábelt külön értékesítik.
- IT** Questo cavo è venduto separatamente.
- LV** Šis kabelis tiek pārdots atsevišķi.
- LT** Šis kabelis parduodamas atskirai.
- MK** Овој кабел се продава одделно.
- NO** Denne kabelen selges separat.
- PL** Ten kabel jest sprzedawany osobno.
- PT** Este cabo é vendido separadamente.
- RO** Acest cablu este vândut separat.
- RU** Этот кабель продается отдельно.
- SR** Ovaj kabel se prodaje odvojeno.
- SK** Tento kábel sa predáva osobitne.
- SL** Ta kabel se prodaja ločeno.
- ES** Este cable se vende separadamente.
- SV** Denna kabel säljs separat.
- TR** Bu kablo ayrı satılır.
- UA** Цей кабель продається окремо.

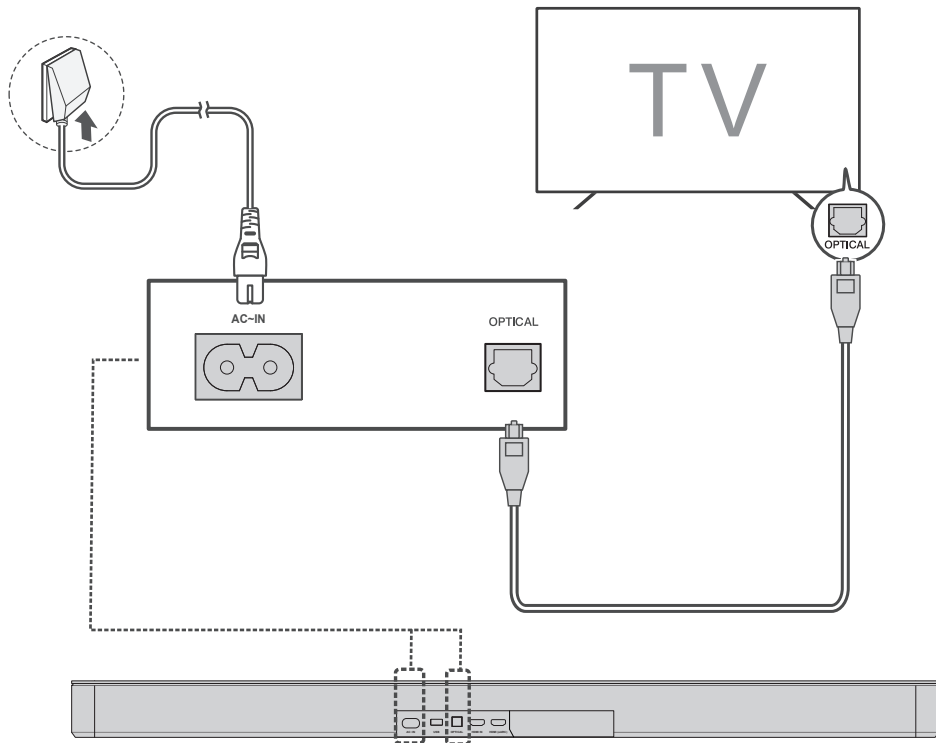

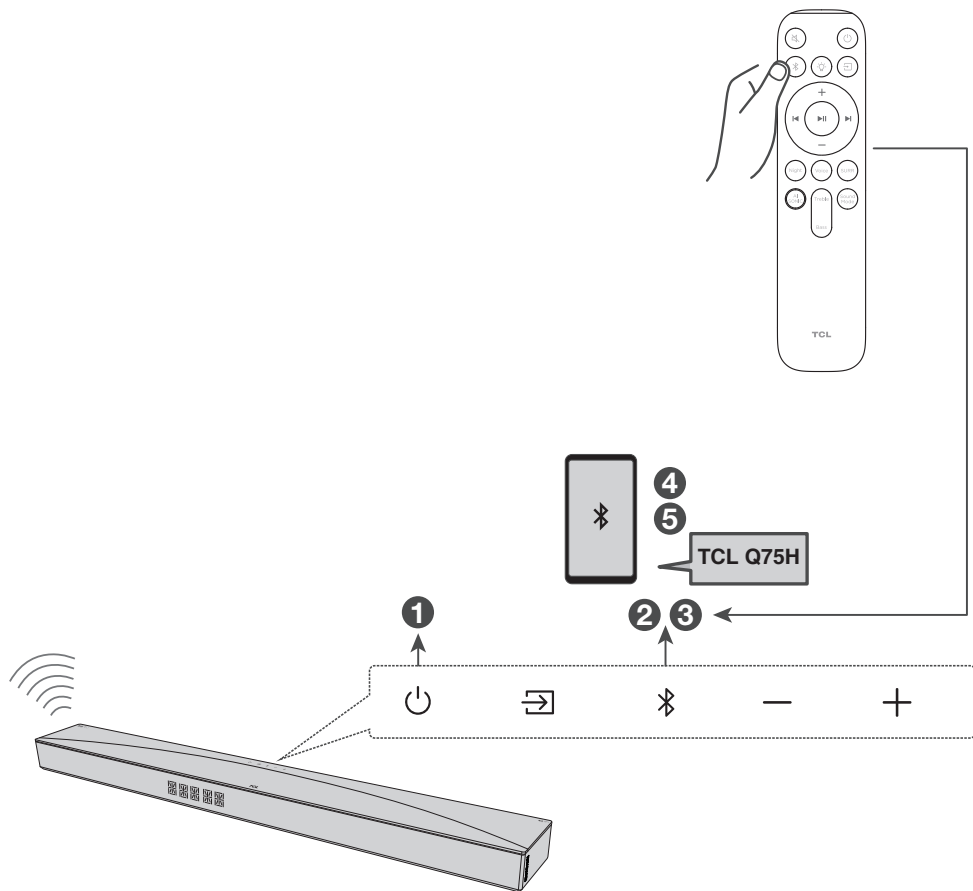



1

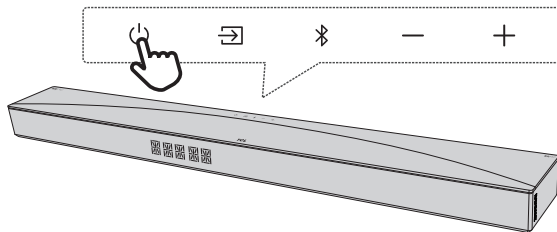

2

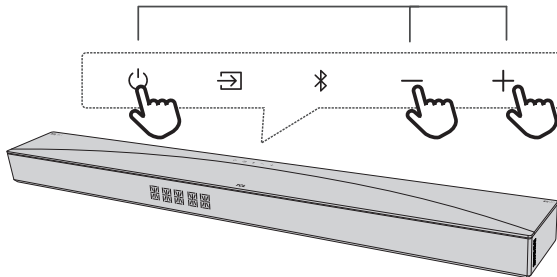

3



4



5

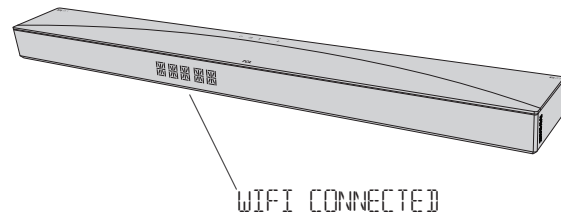



- EN** Supported audio files: MP3, WMA, WAV, FLAC. USB format: FAT and FAT 32.
- SQ** Skedarët audio të mbështetur: MP3, WMA, WAV, FLAC. Formatet USB: FAT dhe FAT 32.
- BG** Поддржани аудио файлове: MP3, WMA, WAV, FLAC. USB формати: FAT и FAT 32.
- HR** Podržane audio datoteke: MP3, WMA, WAV, FLAC. USB formati: FAT i FAT 32.
- CZ** Podporované zvukové soubory: MP3, WMA, WAV, FLAC. Formáty USB: FAT a FAT 32.
- DA** Understøttede lydfiler: MP3, WMA, WAV, FLAC. USB-format: FAT og FAT 32.
- NL** Ondersteunde audiobestanden: MP3, WMA, WAV, FLAC. USB-indelingen: FAT en FAT 32.
- ET** Toetatud audiofailid: MP3, WMA, WAV, FLAC. USB-formaadid: FAT ja FAT 32.
- FI** Tuetut äänitiedostot: MP3, WMA, WAV, FLAC. USB-formaatit: FAT ja FAT 32.
- FR** Fichiers audio compatibles : MP3, WMA, WAV, FLAC. Format USB : FAT et FAT 32.
- DE** Unterstützte Audiodateien: MP3, WMA, WAV, FLAC. USB-Formate: FAT und FAT 32.
- EL** Υποστηρίξιµενα αρχεία ήχου: MP3, WMA, WAV, FLAC. Μορφές USB: FAT και FAT 32.
- HU** Támogatott hangfájlok: MP3, WMA, WAV, FLAC. USB formátumok: FAT és FAT 32.
- IT** File audio supportati: MP3, WMA, WAV, FLAC. Formato USB: FAT e FAT 32.
- LV** Atbalstītie audio faili: MP3, WMA, WAV, FLAC. USB formāti: FAT un FAT 32.
- LT** Palaikomi garso failai: MP3, WMA, WAV, FLAC. USB formatai: FAT ir FAT 32.
- MK** Поддржани аудио датотеки: MP3, WMA, WAV, FLAC. USB формати: FAT и FAT 32.
- NO** Støttede lydfiler: MP3, WMA, WAV, FLAC. USB-format: FAT og FAT 32.
- PL** Obsługiwane pliki audio: MP3, WMA, WAV, FLAC. Format USB: TLUSZCZ i TLUSZCZ 32.
- PT** Ficheiros de áudio suportados: MP3, WMA, WAV, FLAC. Formato USB: FAT e FAT 32.
- RO** Fişiere audio acceptate: MP3, WMA, WAV, FLAC. Format USB: FAT și FAT 32.
- RU** Поддерживаемые аудиофайлы: MP3, WMA, WAV, FLAC. Формат USB: FAT и FAT 32.
- SR** Podržani audio formati: MP3, WMA, WAV, FLAC. USB formati: FAT i FAT 32.
- SK** Podporované zvukové súbory: MP3, WMA, WAV, FLAC. Formáty USB: FAT a FAT 32.
- SL** Podprte zvočne datoteke: MP3, WMA, WAV, FLAC. Formati USB: FAT in FAT 32.
- ES** Archivos de audio compatibles: MP3, WMA, WAV, FLAC. Formato USB: FAT y FAT 32.
- SV** Ljudfiler som stöds: MP3, WMA, WAV, FLAC. USB-format: FAT och FAT 32.
- TR** Desteklenen ses dosyaları: MP3, WMA, WAV, FLAC. USB formatları: FAT ve FAT 32.
- UA** Підтримувані аудіофайли: MP3, WMA, WAV, FLAC. Формати USB: FAT і FAT 32.

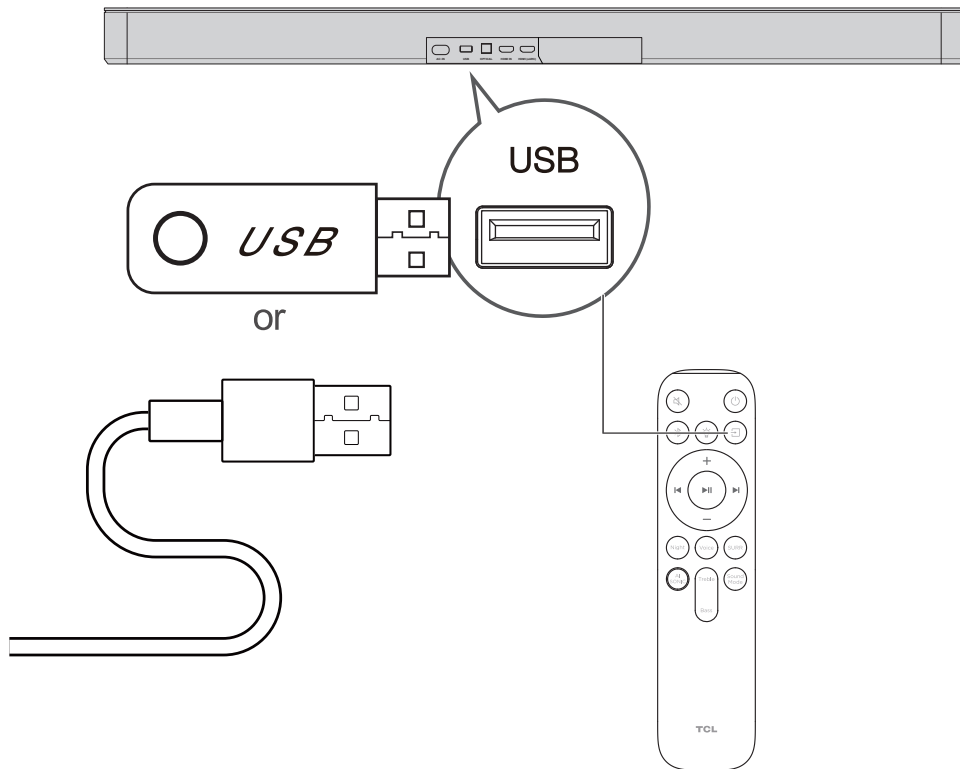



TCL Tutti Choral

Settings → Display & Sound → Audio Output →
Internal Speaker+Soundbar(HDMI)

TCL TV
Ready

EN This function is available in some TCL TVs and some TCL models.
BG Къто версия е налична на телевизорите и згідно TCL дні згідно моделі TCL.
HR Ova je značajka dostupna na odabranim TCL televizorima i odabranim TCL modelima.
CZ Tato funkce je k dispozici u vybraných televizorů TCL a vybraných modelů TCL.
DA Denne funktion er tilgængelig på udvalgte TCL tv'er og udvalgte TCL modeller.
NL Deze functie is beschikbaar op bepaalde TCL tv's en bepaalde TCL modellen.
FI Tämä ominaisuus on saatavilla valituilla TCL televisioilla ja tietyillä TCL mallieilla.
FR Cette fonction est disponible sur certains téléviseurs TCL et certains modèles TCL.
DE Diese Funktion ist auf ausgewählten TCL Fernsehern und ausgewählten TCL Modellen verfügbar.
EL Εξ αυτής της λειτουργίας είναι διαθέσιμη η λειτουργία αυτής της TCL μοντέλου.
HU Ez a funkció csak bizonyos TCL TV-ken és egyes TCL modelleken érhető el.
IT Questa funzione è disponibile su alcuni televisori TCL e su alcuni modelli TCL.
LV Šī funkcija ir pieejama atsevišķos TCL televizoru un atsevišķos TCL modeļos.
LT Ši funkcija pasiekiama tam tikrose TCL televizoruose ir tam tikrose TCL modeliuose.
NO Oessa funksjonen er tilgjengelig på utvalgte TCL TV-er og utvalgte TCL modeller.
PL Ta funkcja jest dostępna w wybranych telewizorach TCL i wybranych modelach TCL.
PT Este recurso está disponível em TVs TCL selecionadas e modelos TCL selecionados.
RO Această caracteristică este disponibilă pe anumite televizoare TCL și anumite modele TCL.
RU Эта функция доступна в некоторых телевизорах TCL и некоторых моделях TCL.
SR Ova funkcija je dostupna na odabranim TCL televizorima i izabranim TCL modelima.
SK Táto funkcia je k dispozícii na vybraných televízoroch TCL a vybraných modeloch TCL.
SL Ta funkcija je na voljo na izbranih televizorih TCL in izbranih modelih TCL.
ES Esta función está disponible en algunos televisores TCL y algunos modelos TCL.
SV Den här funktionen är tillgänglig på utvalda TCL TV-apparater och utvalda TCL modeller.
TR Bu özellik, belirli TCL TV'lerinde ve belirli TCL modellerinde mevcuttur.
UA Ця функція доступна на деяких телевізорах TCL і деяких моделях TCL.
EN The message displayed may differ with the TV model.
SO Información i shfaqur mund të ndryshojë në varësi të modelit televiziv.
BG Показаната информация може да варира в зависимост от модела на телевизора.
HR Prikazane informacije mogu se razlikovati ovisno o modelu televizora.
CZ Zobrazené informácie sa môžu líšiť v závislosti od modelu televízora.
DA De viste oplysninger kan variere afhængigt af tv modelen.
NL De weergegeven informatie kan variëren afhankelijk van het tvmodel.
NL Kuvutat teave võib teleri mudelst sõltuvalt erineda.
FI Näytettävät tiedot voivat vaihdella TV mallin mukaan.
FR Le message affiché peut varier selon le modèle de téléviseur.
DE Die angezeigten Informationen können je nach TV-Modell variieren.
EL Οι πληροφορίες που εμφανίζονται ενδέχεται να διαφέρουν ανάλογα με το μοντέλο της τηλεόρασης.
HU A megjelenített információk a TVmodellről függően változhatnak.
IT Le informazioni visualizzate possono variare a seconda del modello di TV.
LV Parādītā informācija var atšķirties atkarībā no televizora modeļa.
LT Rodoma informacija gali skirtis priklausomai nuo televizoriaus modelio.
NO Prækjænte informasjonsi kunne vere forskjellig avhengig av TV-modellen.
PL Wyświetlane informacje mogą się różnić w zależności od modelu telewizora.
PT As informações exibidas podem variar dependendo do modelo de TV.
RO Informațiile afișate pot varia în funcție de modelul televizorului.
RU Отображаемые сообщения могут отличаться в зависимости от модели телевизора.
SR Prikazane informacije mogu da se razlikuju u zavisnosti od TV modela.
SK Zobrazené informácie sa môžu líšiť v závislosti od modelu televízora.
SL Prikazane informacije se lahko razlikujejo glede na model televizora.
ES El mensaje mostrado puede diferir según el modelo del televisor.
SV Informationen som visas kan variera beroende på TV-modell.
TR Görüntülenen bilgiler TV modeline bağlı olarak değişebilir.
UA Інформація, що відображається, може відрзнятися залежно від моделі телевізора.

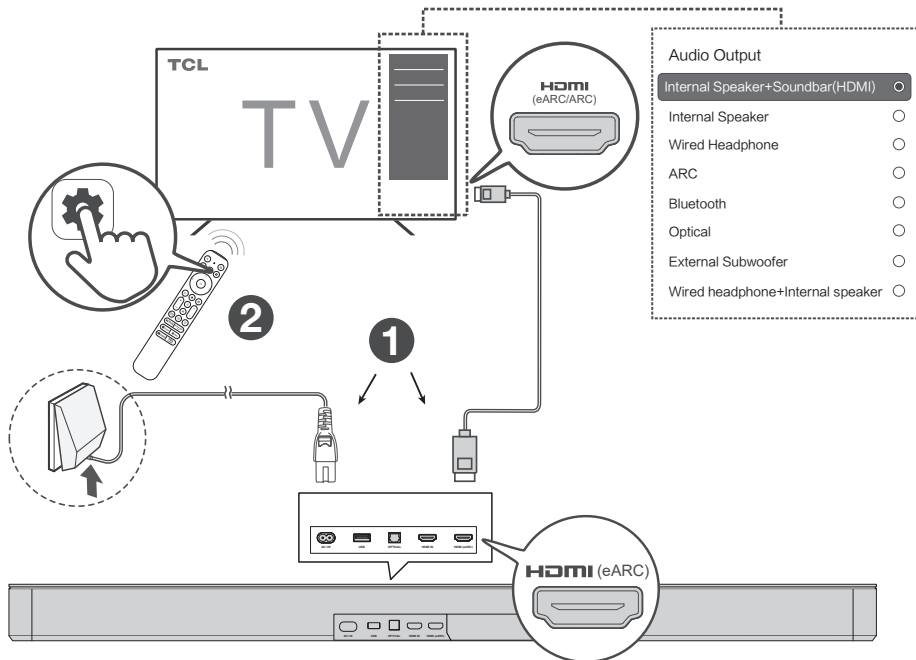

12



TCL HOME



TCL Home App
Your TCL Smart Hub.
Download Now!

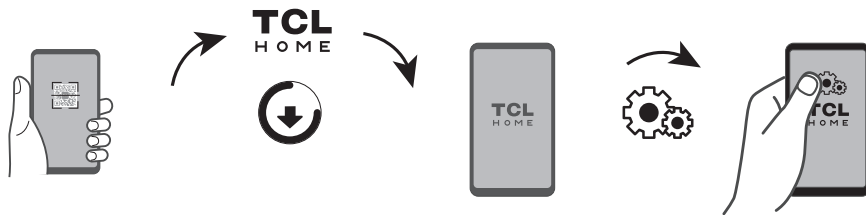

13



AI Sonic-Adaptation

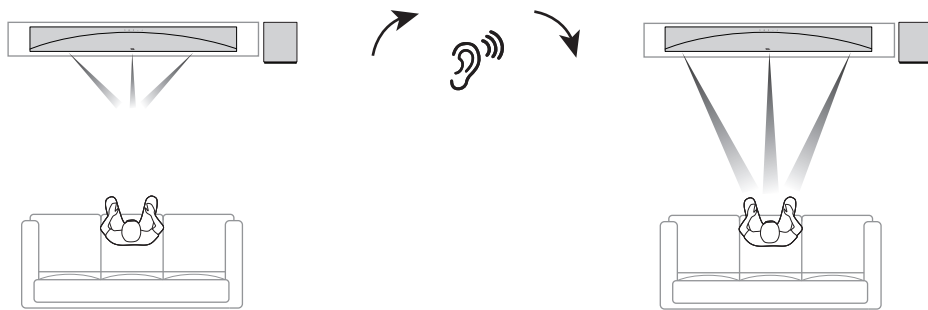

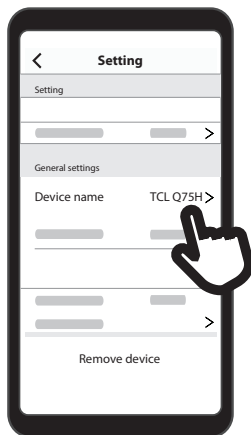

1

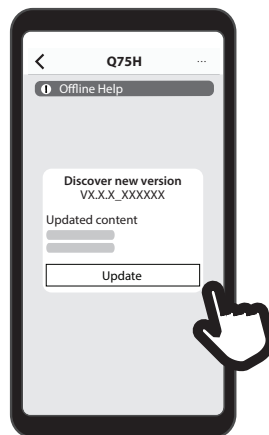

2

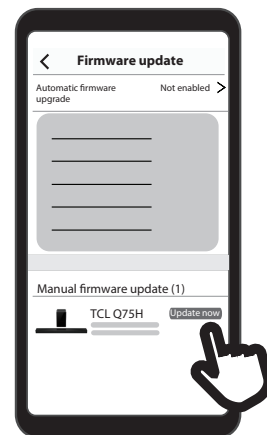

3

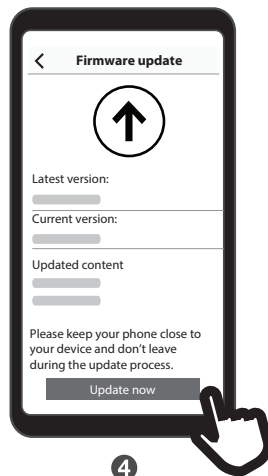

4

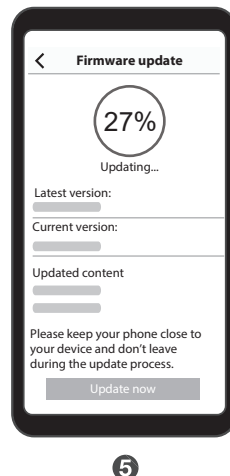

5

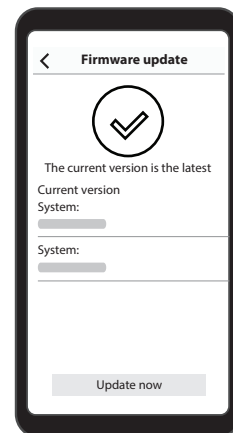

Trademarks



Apple, AirPlay, Apple Home, and Apple TV are trademarks of Apple Inc., registered in the U.S. and other countries and regions.



Dolby, Dolby Atmos, and the double-D symbol are registered trademarks of Dolby Laboratories Licensing Corporation. Manufactured under license from Dolby Laboratories. Confidential unpublished works. Copyright © 2012-2024 Dolby Laboratories. All rights reserved.



The Bluetooth® word mark and logos are registered trademarks owned by Bluetooth SIG, Inc. and any use of such marks by TTE Corporation is under license. Other trademarks and trade names are those of their respective owners.



For DTS patents, see <http://patents.dts.com>. Manufactured under license from DTS Licensing Limited. DTS, DTS:X, and the DTS:X logo are registered trademarks or trademarks of DTS, Inc. in the United States and other countries. © 2024 DTS, Inc. ALL RIGHTS RESERVED.



"The terms HDMI, HDMI High-Definition Multimedia Interface, HDMI trade dress and the HDMI Logos are trademarks or registered trademarks of HDMI Licensing Administrator, Inc."



The Wi-Fi CERTIFIED™ Logo is a certification mark of Wi-Fi Alliance®.

EN

Radio information

Soundbar

- Bluetooth frequency range: 2400 – 2483.5 MHz
- Bluetooth transmitter power: <13 dBm (EIRP)
- Wi-Fi network: IEEE 802.11 a/b/g/n/ac (2.4GHz/5GHz)
- 2.4G Wi-Fi frequency range: 2412 – 2472 MHz
- 2.4G Wi-Fi transmitter power: < 20 dBm (EIRP)
- 5G Wi-Fi frequency range: 5.15 – 5.35 GHz,
- 5.470 – 5.725 GHz, 5.725 – 5.825 GHz
- 5G Wi-Fi transmitter power: < 23 dBm (EIRP)
- 2.4G Wireless frequency range: 2406 – 2474MHz
- 2.4G Wireless transmitter power: <10 dBm (EIRP)

Radio information

Subwoofer

- Frequency range: 2406MHz-2474MHz
- Maximum power (EIRP): 10dBm

For 5G WIFI Device

The device for operation in the band 5150-5350 MHz is only for indoor use to reduce the potential for harmful interference to co-channel mobile satellite systems.

* Operation of 5150–5350MHz is restricted to indoor use only.

	BE	BG	CZ	DK	DE	EE	IE
	EL	ES	FR	HR	IT	CY	LV
	LT	LU	HU	MT	NL	AT	PL
	PT	RO	SI	SK	FI	SE	UK (NI)

HR

Informacije o radiju

Zvučna traka

- Bluetooth frekvenjski raspon: 2400 – 2483,5 MHz
- Snaga Bluetooth odašiljača: <13 dBm (EIRP)
- Wi-Fi mreža: IEEE 802.11 a/b/g/n/ac (2.4GHz/5GHz)
- 2,4G Wi-Fi frekvenjskog raspona: 2412 – 2472 MHz
- 2,4G Snaga Wi-Fi odašiljača: < 20 dBm (EIRP)
- Frekvenjski raspon 5G Wi-Fi: 5,15 – 5,35 GHz, 5,470 – 5,725 GHz, 5,725 – 5,825 GHz
- Snaga 5G Wi-Fi odašiljača: < 23 dBm (EIRP)
- 2,4G bežični frekvenjski raspon: 2406 – 2474MHz
- 2,4G snaga bežičnog odašiljača: <10 dBm (EIRP)

Informacije o radiju

Subwoofer

- Frekvenjski raspon: 2406MHz-2474MHz
- Maksimalna snaga (EIRP): 10dBm

RADI NA 5G WIFI Uredajima

Oprema koja radi u pojasu 5150–5350 MHz namijenjena je za unutarnju uporabu samo kako bi se smanjio potencijal štetnih smetnji za kokanalne mobilne satelitske sustave.

* Rad na 5150–5350MHz ograničen je samo na unutarnju upotrebu.

	BE	BG	CZ	DK	DE	EE	IE
	EL	ES	FR	HR	IT	CY	LV
	LT	LU	HU	MT	NL	AT	PL
	PT	RO	SI	SK	FI	SE	UK (NI)

SQ

Informacion radiofonik

Soundbar

- Gama e frekuencave Bluetooth: 2400 - 2483.5 MHz
- Fuqja e transmetuesit Bluetooth: <13 dBm (EIRP)
- Rrjeti Wi-Fi: IEEE 802.11 a/b/g/n/ac (2.4GHz/5GHz)
- Gama e frekuencave Wi-Fi 2.4G: 2412 - 2472 MHz
- Fuqja transmetuese Wi-Fi 2.4G: < 20 dBm (EIRP)
- Gama e frekuencave Wi-Fi 5G: 5.15 - 5.35 GHz, 5.470 - 5.725 GHz, 5.725 - 5.825 GHz
- Fuqja e transmetuesit Wi-Fi 5G: < 23 dBm (EIRP)
- 2,4G Gama e frekuencave Wireless: 2406 - 2474 MHz
- Fuqja transmetuese pa tel 2,4G: <10 dBm (EIRP)

Informacion radiofonik

Altoperant bas

- Gama e frekuencave: 2406 MHz - 2474 MHz
- Fuqja maksimale (EIRP): 10dBm

I disponueshëm për pajisjet 5G WIFI

Pajisjet që operojnë në bandën 5150-5350 MHz kanë për qëllim përdorimin e brendshëm vetëm për të zgjedhur mundësinë e ndërhyrjes së dëmshme në bashkë-kanalin e sistemeve satelitore mobile.

* Operacioni në 5150–5350MHz është i kufizuar vetëm në përdorim të brendshëm.

	BE	BG	CZ	DK	DE	EE	IE
	EL	ES	FR	HR	IT	CY	LV
	LT	LU	HU	MT	NL	AT	PL
	PT	RO	SI	SK	FI	SE	UK (NI)

CZ

Rádiové informace

Soundbaru

- Frekvenční rozsah Bluetooth: 2400 – 2483,5 MHz
- Výkon Bluetooth vysílače: <13 dBm (EIRP)
- Síť Wi-Fi: IEEE 802.11 a/b/g/n/ac (2.4GHz/5GHz)
- Frekvenční rozsah 2.4G Wi-Fi: 2412 – 2472 MHz
- Výkon vysílače 2.4G Wi-Fi: < 20 dBm (EIRP)
- Frekvenční rozsah 5G Wi-Fi: 5,15 – 5,35 GHz, 5,470 – 5,725 GHz, 5,725 – 5,825 GHz
- Výkon vysílače 5G Wi-Fi: < 23 dBm (EIRP)
- Bezdrátový frekvenční rozsah 2.4G: 2406 - 2474 MHz
- Výkon bezdrátového vysílače 2.4G: <10 dBm (EIRP)

Rádiové informace

Subwoofer

- Frekvenční rozsah: 2406MHz-2474MHz
- Maximální výkon (EIRP): 10dBm

K dispozici pro zařízení 5G WIFI

Zařízení pracující v pásmu 5150–5350 MHz jsou určena pouze pro vnitřní použití, aby se snížila možnost škodlivého rušení mobilních satelitních systémů na společném kanálu.

* Provoz na frekvenci 5150–5350 MHz je omezen pouze na vnitřní použití.

	BE	BG	CZ	DK	DE	EE	IE
	EL	ES	FR	HR	IT	CY	LV
	LT	LU	HU	MT	NL	AT	PL
	PT	RO	SI	SK	FI	SE	UK (NI)

BG

Радио информация

Саунд бар

- Bluetooth честотен диапазон: 2400 - 2483.5 MHz
- Мощност на Bluetooth предавателя: <13 dBm (EIRP)
- Wi-Fi мрежа: IEEE 802.11 a/b/g/n/ac (2.4 GHz / 5 GHz)
- 2.4G Wi-Fi честотен диапазон: 2412 - 2472 MHz
- Мощност на 2.4G Wi-Fi предавателя: < 20 dBm (EIRP)
- 5G Wi-Fi честотен диапазон: 5.15 - 5.35 GHz, 5.470 - 5.725 GHz, 5.725 - 5.825 GHz
- Мощност на 5G Wi-Fi предавателя: < 23 dBm (EIRP)
- 2.4G безжичен честотен диапазон: 2406 – 2474 MHz
- 2,4G мощност на безжичния предавател: <10 dBm (EIRP)

Радио информация

Събуфер

- Честотен диапазон: 2406 MHz - 2474 MHz
- Максимална мощност (EIRP): 10dBm

Предлага се за 5G WIFI устройства

Оборудването, работещо в радиочестотната лента 5150 - 5350 MHz, е предназначено за използване в закрити помещения само за намаляване на възможността за вредни смущения в коканалните мобилни състъпникови системи.

* Работата при 5150–5350MHz е ограничена само до вътрешна употреба.

	BE	BG	CZ	DK	DE	EE	IE
	EL	ES	FR	HR	IT	CY	LV
	LT	LU	HU	MT	NL	AT	PL
	PT	RO	SI	SK	FI	SE	UK (NI)

DA

Udsendelsesinformation

Soundbar

- Bluetooth frekvensområde: 2400 – 2483,5 MHz
- Bluetooth sendereffekt: <13 dbm (EIRP)
- Trådløs netværk: IEEE 802.11 a/b/g/n/ac (2.4ghz/5Ghz)
- 2,4G Wi-Fi frekvensområde: 2412 – 2472 MHz
- 2,4G Wi-Fi sendereffekt: <20 dbm (EIRP)
- 5G Wi-Fi frekvensområde: 5,15 – 5,35 GHz, 5,470 – 5,725 GHz, 5,725 – 5,825 GHz
- 5G Wi-Fi sendereffekt: < 23 dbm (EIRP)
- 2,4G trådløs frekvensområde: 2406 – 2474MHz
- 2,4G trådløs transmissionseffekt: <10 dbm (EIRP)

Udsendelsesinformation

Subwoofer

- Frekvensområde: 2406MHz-2474MHz
- Maksimal effekt (EIRP): 10dBm

Velegnet til 5G WIFI-enheder

Udstyr, der opererer i 5150-5350 mhz-båndet, er kun beregnet til indendørs brug for at reducere risikoen for skadelig interferens til mobile satellitsystemer med fælles kanaler.

*Drift ved 5150–5350mhz er kun til indendørs brug.

	BE	BG	CZ	DK	DE	EE	IE
	EL	ES	FR	HR	IT	CY	LV
	LT	LU	HU	MT	NL	AT	PL
	PT	RO	SI	SK	FI	SE	UK (NI)

NL

Radio-informatie

Soundbar

- Bluetooth-frequentiebereik: 2400 - 2483,5 MHz
- Bluetooth-zendvermogen: <13 dBm (EIRP)
- Wi-Fi-netwerk: IEEE 802.11 a/b/g/n/ac (2,4 GHz/5 GHz)
- 2,4G WLAN-frequentiebereik: 2412 - 2472 MHz
- 2,4G WLAN-transmissievermogen: < 20 dBm (EIRP)
- 5G WLAN-frequentiebereik: 5,15 - 5,35 GHz, 5,470 - 5,725 GHz, 5,725 - 5,825 GHz
- 5G WLAN-zendvermogen: < 23 dBm (EIRP)
- 2,4G-radiofrequentiebereik: 2406 - 2474 MHz
- 2,4G-radiotransmissievermogen: <10 dBm (EIRP)

Radio-informatie

Subwoofer

- Frequentiebereik: 2406 MHz-2474 MHz
- Maximaal vermogen (EIRP): 10 dBm

Geschikt voor 5G WLAN-apparaten

Apparaten die werken in de 5150-5350 MHz-band zijn alleen bedoeld voor gebruik binnenshuis om het risico van schadelijke interferentie met mobiele satellietstelsystemen op hetzelfde kanaal te minimaliseren.

*Werking op 5150-5350 MHz is alleen bedoeld voor gebruik binnenshuis.



BE	BG	CZ	DK	DE	EE	IE
EL	ES	FR	HR	IT	CY	LV
LT	LU	HU	MT	NL	AT	PL
PT	RO	SI	SK	FI	SE	UK (NI)

FR

Informations radio

Barre de son

- Plage de fréquences Bluetooth : 2400 – 2483,5 MHz
- Puissance de l'émetteur Bluetooth : <13 dBm (EIRP)
- Réseau Wi-Fi : IEEE 802.11 a/b/g/n/ac (2,4GHz/5GHz)
- Plage de fréquences du Wi-Fi 2.4G : 2412 – 2472 MHz
- Puissance de l'émetteur Wi-Fi 2.4G : < 20 dBm (EIRP)
- Plage de fréquences du Wi-Fi 5G : 5,15 – 5,35 GHz, 5,470 – 5,725 GHz, 5,725 – 5,825 GHz
- Puissance de l'émetteur Wi-Fi 5G : < 23 dBm (EIRP)
- Plage de fréquences sans fil 2.4G: 2406 – 2474MHz
- Puissance de l'émetteur sans fil 2.4G : <10 dBm (EIRP)

Informations radio

Caisson de basses

- Plage de fréquence : 2406MHz-2474MHz
- Puissance maximale (EIRP) : 10dBm

Pour l'appareil WIFI 5G

L'appareil fonctionnant dans la bande 5150-5350 MHz ne doit être utilisé qu'à l'intérieur des bâtiments afin de réduire le risque d'interférences nuisibles avec les systèmes mobiles par satellite à canal commun.

* L'utilisation de la bande 5150-5350 MHz est limitée à l'intérieur des bâtiments.



BE	BG	CZ	DK	DE	EE	IE
EL	ES	FR	HR	IT	CY	LV
LT	LU	HU	MT	NL	AT	PL
PT	RO	SI	SK	FI	SE	UK (NI)

ET

Raadioinfo

Soundbar

- Bluetoothi sagedusala: 2400 - 2483,5 MHz
- Bluetooth-ülekandevõimsus: <13 dBm (EIRP)
- Wi-Fi võrk: IEEE 802.11 a/b/g/n/ac (2,4 GHz/5 GHz)
- 2,4G WLAN-sagedusvahemik: 2412 - 2472 MHz
- 2,4G WLAN-i edastusvõimsus: < 20 dBm (EIRP)
- 5G WLAN-sagedusvahemik: 5,15-5,35 GHz, 5,470-5,725 GHz, 5,725-5,825 GHz.
- 5G WLAN saatja võimsus: < 23 dBm (EIRP)
- 2,4G raadiosagedusvahemik: 2406 - 2474 MHz
- 2,4G raadiosaatjate võimsus: <10 dBm (EIRP)

Raadioinfo

Subwoofer

- Sagedusvahemik: 2406 MHz-2474 MHz
- Maksimaalne võimsus (EIRP): 10 dBm

Sobib 5G WLAN-seadmetele

5150-5350 MHz sagedusala töötavad seadmed on ette nähtud ainult siseruumides kasutamiseks, et minimeerida kahjulike häirete tekkimise ohtu kaaskanaliga liikuvatele satelliitsüsteemidele.

*Kasutamine sagedusala 5150-5350 MHz on ette nähtud ainult siseruumides kasutamiseks.



BE	BG	CZ	DK	DE	EE	IE
EL	ES	FR	HR	IT	CY	LV
LT	LU	HU	MT	NL	AT	PL
PT	RO	SI	SK	FI	SE	UK (NI)

DE

Radio-Informationen

Soundbar

- Bluetooth-Frequenzbereich: 2400 – 2483,5 MHz
- Bluetooth-Sendeleistung: <13 dBm (EIRP)
- Wi-Fi-Netzwerk: IEEE 802.11 a/b/g/n/ac (2,4 GHz/5 GHz)
- 2,4G-WLAN-Frequenzbereich: 2412 – 2472 MHz
- 2,4G-WLAN-Sendeleistung: < 20 dBm (EIRP)
- 5G-WLAN-Frequenzbereich: 5,15 – 5,35 GHz, 5,470 – 5,725 GHz, 5,725 – 5,825 GHz
- 5G-WLAN-Senderleistung: < 23 dBm (EIRP)
- 2,4G-Funkfrequenzbereich: 2406 – 2474 MHz
- 2,4G-Funkübertragungsleistung: <10 dBm (EIRP)

Radio-Informationen

Subwoofer

- Frequenzbereich: 2406 MHz-2474 MHz
- Maximale Leistung (EIRP): 10 dBm

Geeignet für 5G-WLAN-Geräte

Geräte, die im 5150-5350-MHz-Band betrieben werden, sind nur für die Verwendung in Innenräumen vorgesehen, um das Risiko schädlicher Störungen bei mobilen Satellitensystemen mit Gleichkanal zu verringern.

*Der Betrieb bei 5150-5350 MHz ist nur für die Verwendung in Innenräumen vorgesehen.



BE	BG	CZ	DK	DE	EE	IE
EL	ES	FR	HR	IT	CY	LV
LT	LU	HU	MT	NL	AT	PL
PT	RO	SI	SK	FI	SE	UK (NI)

FI

Radiotiedot

Soundbar

- Bluetooth-taajuusalue: 2400 - 2483,5 MHz
- Bluetooth-lähetysteho: <13 dBm (EIRP)
- Wi-Fi-verkko: IEEE 802.11 a/b/g/n/ac (2,4 GHz/5 GHz)
- 2,4G WLAN-taajuusalue: 2412 - 2472 MHz
- 2,4G WLAN:n lähetysteho: < 20 dBm (EIRP)
- 5G WLAN-taajuusalue: 5,15 - 5,35 GHz, 5,470 - 5,725 GHz, 5,725 - 5,825 GHz.
- 5G WLAN-lähetysteho: < 23 dBm (EIRP)
- 2,4G-radiotaajuusalue: 2406 - 2474 MHz
- 2,4G-radiolähetysteho: <10 dBm (EIRP)

Radiotiedot

Subwoofer

- Taajuusalue: 2406 MHz-2474 MHz
- Suurin teho (EIRP): 10 dBm

Soveltuu 5G WLAN-laitteille

Laitteet, jotka toimivat 5150-5350 MHz:n taajuusalueella, on tarkoitettu vain sisäkäyttöön, jotta minimoitään haitallisten häiriöiden riski samankanaalisella satelliittivälitteille matkaviestinjärjestelmille.

*Toiminta 5150-5350 MHz:n taajuusalueella on tarkoitettu vain sisäkäyttöön.



BE	BG	CZ	DK	DE	EE	IE
EL	ES	FR	HR	IT	CY	LV
LT	LU	HU	MT	NL	AT	PL
PT	RO	SI	SK	FI	SE	UK (NI)

EL

Πληροφορίες εκπομπής

Ηχομητρ

- Έυρος συχνότητας Bluetooth: 2400 - 2483,5 MHz
- Ισχύς πομπού Bluetooth: <13 dBm (EIRP)
- Δίκτυο Wi-Fi: IEEE 802.11 a/b/g/n/ac (2,4 GHz/5 GHz)
- Έυρος συχνότητας 2,4G Wi-Fi: 2412 - 2472 MHz
- Ισχύς πομπού 2,4G Wi-Fi: < 20 dBm (EIRP)
- Έυρος συχνότητας 5G Wi-Fi: 5,15 - 5,35 GHz, 5,470 - 5,725 GHz, 5,725 - 5,825 GHz
- Ισχύς πομπού 5G Wi-Fi: < 23 dBm (EIRP)
- Έυρος ασύρματης συχνότητας 2,4 G: 2406 - 2474 MHz
- Ισχύς ασύρματης μετάδοσης 2,4G: <10 dBm (EIRP)

Πληροφορίες εκπομπής

Υποwoofer

- Έυρος συχνότητας: 2406 MHz - 2474 MHz
- Μέγιστη ισχύς (EIRP): 10 dBm

Κατάλληλο για συσκευές 5G WIFI

Ο εξοπλισμός που λειτουργεί στη ζώνη 5150-5350 MHz προορίζεται για χρήση σε εσωτερικούς χώρους μόνο για τη μείωση της πιθανότητας εμφάνισης παρεμβολών σε κινητά δορυφορικά συστήματα συν-καναλιών.

*Η λειτουργία στα 5150 - 5350 MHz είναι μόνο για χρήση σε εσωτερικούς χώρους.



BE	BG	CZ	DK	DE	EE	IE
EL	ES	FR	HR	IT	CY	LV
LT	LU	HU	MT	NL	AT	PL
PT	RO	SI	SK	FI	SE	UK (NI)

HU

Közvetítési információk

Hangsáv

- Bluetooth frekvenciatartomány: 2400 - 2483,5 MHz
- Bluetooth adóteljesítmény: <13 dBm (EIRP)
- Wi-Fi hálózat: IEEE 802.11 a/b/g/n/ac (2,4 GHz/5 GHz)
- 2,4G Wi-Fi frekvenciatartomány: 2412 - 2472 MHz
- 2,4 G Wi-Fi adóteljesítmény: < 20 dBm (EIRP)
- 5G Wi-Fi frekvenciatartomány: 5,15 - 5,35 GHz, 5,470 - 5,725 GHz, 5,725 - 5,825 GHz
- 5G Wi-Fi adóteljesítmény: < 23 dBm (EIRP)
- 2,4G vezeték nélküli frekvenciatartomány: 2406 - 2474 MHz
- 2,4G vezeték nélküli átviteli teljesítmény: <10 dBm (EIRP)

Közvetítési információk

Basszus

- Frekvencia tartomány: 2406 MHz - 2474 MHz
- Maximális teljesítmény (EIRP): 10 dBm

Alkalmas 5G WIFI eszközökhöz

Az 5150-5350 MHz -es sávban működő berendezéseket csak beltéri használatra szánják, hogy csökkentsek a közös csatornás mobil műholdas rendszereket érő radio interferencia lehetőségét.

- * Az 5150-5350 MHz-es frekvencia csak beltéri használatra korlátozódik.

	BE	BG	CZ	DK	DE	EE	IE
	EL	ES	FR	HR	IT	CY	LV
	LT	LU	HU	MT	NL	AT	PL
	PT	RO	SI	SK	FI	SE	UK (NI)

LT

Transliuoti informacija

Garso juosta

- Bluetooth dažnių diapazonas: 2400 – 2483,5 MHz
- Bluetooth siųstuvo galia: <13 dbm (EIRP)
- Wi-Fi tinklas: IEEE 802.11 a/b/g/n/ac (2,4 GHz/5 GHz)
- 2,4G Wi-Fi dažnių diapazonas: 2412 – 2472 MHz
- 2,4 G Wi-Fi siųstuvo galia: < 20 dBm (EIRP)
- 5G Wi-Fi dažnių diapazonas: 5,15–5,35 GHz, 5,470–5,725 GHz, 5,725–5,825 GHz
- 5G Wi-Fi siųstuvo galia: < 23 dBm (EIRP)
- 2,4G Belaidžio dažnių diapazonas: 2406 – 2474MHz
- 2,4 G Belaidžio perdavimo galia: <10 dBm (EIRP)

Transliuoti informacija

Bosas

- Dažnių diapazonas: 2406MHz-2474MHz
- Didžiausia galia (EIRP): 10 dBm

Tinka 5G WIFI įrenginiams

Įranga, veikianti 5150–5350 MHz dažnių juostoje, skirta naudoti tik patalpose, siekiant sumažinti galimus žalingus trikdžius bendro kanalo judriojo palydovinio ryšio sistemoms.

- * Veikimas 5150–5350 MHz dažnių skirtas naudoti tik patalpose.

	BE	BG	CZ	DK	DE	EE	IE
	EL	ES	FR	HR	IT	CY	LV
	LT	LU	HU	MT	NL	AT	PL
	PT	RO	SI	SK	FI	SE	UK (NI)

IT

Informazioni sulla radio

Soundbar

- Intervallo di frequenze Bluetooth: 2400 - 2483,5 MHz
- Potenza del trasmettitore Bluetooth: <13 dBm (EIRP)
- Rete Wi-Fi: IEEE 802.11 a/b/g/n/ac (2,4GHz/5GHz)
- Intervallo di frequenze Wi-Fi 2,4G: 2412 - 2472 MHz
- Potenza del trasmettitore Wi-Fi 2,4G: < 20 dBm (EIRP)
- Intervallo di frequenze Wi-Fi 5G: 5,15 - 5,35 GHz, 5,470 - 5,725 GHz, 5,725 - 5,825 GHz
- Potenza del trasmettitore Wi-Fi 5G: < 23 dBm (EIRP)
- Intervallo di frequenze wireless 2,4G: 2406 - 2474 MHz
- Potenza wireless del trasmettitore 2,4G: <10 dBm (EIRP)

Informazioni sulla radio

Subwoofer

- Intervallo di frequenze: 2406 MHz - 2474 MHz
- Potenza massima (EIRP): 10dBm

Per il Dispositivo WIFI 5G

Il dispositivo per il funzionamento nella banda 5150-5350 MHz è destinato esclusivamente all'uso in interni per ridurre il potenziale di interferenza dannose ai sistemi satellitari mobili co-canale.

- * Il funzionamento di 5150-5350 MHz è limitato all'uso in interni.

	BE	BG	CZ	DK	DE	EE	IE
	EL	ES	FR	HR	IT	CY	LV
	LT	LU	HU	MT	NL	AT	PL
	PT	RO	SI	SK	FI	SE	UK (NI)

МК

Информации за емитување

Лента за звук

- Фреквентен опсег на Bluetooth: 2400 – 2483,5 MHz
- Моќност на предавателот на Bluetooth: <13 dBm (EIRP)
- Wi-Fi мрежа: IEEE 802.11 a/b/g/n/ac (2,4GHz/5GHz)
- 2,4G Wi-Fi фреквентен опсег: 2412 – 2472 MHz
- Моќност на предавателот на 2,4G Wi-Fi: < 20 dBm (EIRP)
- 5G Wi-Fi фреквентен опсег: 5,15 – 5,35 GHz, 5,470 – 5,725 GHz, 5,725 – 5,825 GHz
- Моќност на предавателот 5G Wi-Fi: < 23 dBm (EIRP)
- 2,4G безжичен фреквентен опсег: 2406 – 2474 MHz
- Моќност на безжичен пренос 2,4G: <10 dBm (EIRP)

Информации за емитување

Сабвуфер

- Фреквентен опсег: 2406MHz-2474MHz
- Максимална моќност (EIRP): 10dBm

Погоден за 5G WIFI Уреди

Опремата што работи во опсегот 5150-5350 MHz е наменета само за внатрешна употреба само за да се намали потенцијалот за штетни пречки на мобилните сателитски системи за истоканални канали.

*Работата на 5150–5350 MHz е само за внатрешна употреба.

	BE	BG	CZ	DK	DE	EE	IE
	EL	ES	FR	HR	IT	CY	LV
	LT	LU	HU	MT	NL	AT	PL
	PT	RO	SI	SK	FI	SE	UK (NI)

LV

Apraides informācija

Soundbar

- Bluetooth frekvenču diapazons: 2400 – 2483,5 MHz
- Bluetooth raidītāja jauda: <13 dbm (EIRP)
- Wi-Fi tīkls: IEEE 802.11 a/b/g/n/ac (2,4 GHz/5 GHz)
- 2,4G Wi-Fi frekvenču diapazons: 2412 – 2472 MHz
- 2,4G Wi-Fi raidītāja jauda: < 20 dBm (EIRP)
- 5G Wi-Fi frekvenču diapazons: 5,15–5,35 GHz, 5,470–5,725 GHz, 5,725–5,825 GHz
- 5G Wi-Fi raidītāja jauda: < 23 dBm (EIRP)
- 2,4G Bevadu frekvence diapazons: 2406 – 2474MHz
- 2,4G Bevadu pāraides jauda: <10 dBm (EIRP)

Apraides informācija

Subvāfers

- Frekvencu diapazons: 2406MHz-2474MHz
- Maksimālā jauda (EIRP): 10 dBm

Piemērots 5G WIFI Ierīcēm

Iekārtas, kas darbojas 5150–5350 MHz joslā, ir paredzētas lietošanai tikai iekšējās, lai samazinātu iespējamus kaitīgus traucējumus viena kanāla mobilo satelītu sistēmām.

- *Darbība 5150–5350 MHz ir paredzēta tikai lietošanai iekšējās.

	BE	BG	CZ	DK	DE	EE	IE
	EL	ES	FR	HR	IT	CY	LV
	LT	LU	HU	MT	NL	AT	PL
	PT	RO	SI	SK	FI	SE	UK (NI)

NO

Kringkastingsinformasjon

Soundbar

- Bluetooth frekvensområde: 2400 – 2483,5 MHz
- Bluetooth sendereffekt: <13 dbm (EIRP)
- Trådløst nettverk: IEEE 802.11 a/b/g/n/ac (2,4GHz/5GHz)
- 2,4G Wi-Fi frekvensområde: 2412 – 2472 MHz
- 2,4G Wi-Fi sendereffekt: <20 dBm (EIRP)
- 5G Wi-Fi frekvensområde: 5,15 – 5,35 GHz, 5,470 – 5,725 GHz, 5,725 – 5,825 GHz
- 5G Wi-Fi-sendereffekt: < 23 dbm (EIRP)
- 2,4G trådløs frekvensområde: 2406 – 2474MHz
- 2,4G trådløs sendereffekt: <10 dbm (EIRP)

Kringkastingsinformasjon

Subwoofer

- Frekvensområde: 2406MHz-2474MHz
- Maksimal effekt (EIRP): 10dBm

Passer for 5G WIFI-enheter

Utstyr som opererer i 5150-5350 mhz-båndet er kun beregnet for innendørs bruk for å redusere potensialet for skadelig interferens for co-kanal mobile satellittsystemer.

*Drift ved 5150–5350mhz er kun for innendørs bruk.

	BE	BG	CZ	DK	DE	EE	IE
	EL	ES	FR	HR	IT	CY	LV
	LT	LU	HU	MT	NL	AT	PL
	PT	RO	SI	SK	FI	SE	UK (NI)

PL

Informacje o transmisji

Głośnik SoundBar

- Zakres częstotliwości Bluetooth: 2400 – 2483,5 MHz
- Moc nadajnika Bluetooth: <13 dbm (EIRP)
- Sieć Wi-Fi: IEEE 802.11 a/b/g/n/ac (2,4 GHz/5 GHz)
- Zakres częstotliwości Wi-Fi 2,4G: 2412 – 2472 MHz
- Moc nadajnika Wi-Fi 2,4G: <20 dbm (EIRP)
- Zakres częstotliwości Wi-Fi 5G: 5,15 – 5,35 GHz, 5,470 – 5,725 GHz, 5,725 – 5,825 GHz
- Moc nadajnika Wi-Fi 5G: < 23 dbm (EIRP)
- Zakres częstotliwości bezprzewodowej 2,4G: 2406 – 2474MHz
- Moc nadajnika bezprzewodowej 2,4G: <10 dbm (EIRP)

Informacje o transmisji

Subwoofer

- Zakres częstotliwości: 2406MHz-2474MHz
- Moc maksymalna (EIRP): 10dBm

Nadaje się do urządzeń 5G WIFI

Sprzęt pracujący w paśmie 5150–5350 mhz jest przeznaczony wyłącznie do użytku w pomieszczeniach zamkniętych w celu zmniejszenia potencjału szkodliwych zakłóceń w systemach satelitarnych komunikacji ruchomej współpracujących.

*Praca przy częstotliwości 5150–5350 mhz jest przeznaczona wyłącznie do użytku w pomieszczeniach zamkniętych.



BE	BG	CZ	DK	DE	EE	IE
EL	ES	FR	HR	IT	CY	LV
LT	LU	HU	MT	NL	AT	PL
PT	RO	SI	SK	FI	SE	UK (NI)

RU

Радиоинформация

Канальная звуковая панель (Саундбар)

- Диапазон частот Bluetooth: 2400 - 2483,5 МГц
- Мощность передатчика Bluetooth: <13 дБм (EIRP)
- Сеть Wi-Fi: IEEE 802.11 a/b/g/n/ac (2,4 GHz/5 GHz)
- Диапазон частот 2.4G Wi-Fi: 2412 - 2472 МГц
- Мощность передатчика Wi-Fi 2.4G: < 20 дБм (EIRP)
- Диапазон частот Wi-Fi 5G: 5,15 - 5,35 ГГц, 5,470 - 5,725 ГГц, 5,725 - 5,825 ГГц
- Мощность передатчика Wi-Fi 5G: < 23 дБм (EIRP)
- Беспроводной диапазон частот 2.4G: 2406 - 2474 МГц
- Мощность беспроводного передатчика 2.4G: <10 дБм (EIRP)

Радиоинформация

Сабвуфер

- Диапазон частоты: 2406 МГц – 2474 МГц
- Максимальная мощность (EIRP): 10 дБм

Для устройств 5G WIFI

Устройство для работы в диапазоне 5150-5350 МГц предназначено только для использования в помещении, чтобы уменьшить вероятность вредных помех для одноканальных мобильных спутниковых систем.

* Работа в диапазоне 5150-5350 МГц ограничена использованием только внутри помещений.



BE	BG	CZ	DK	DE	EE	IE
EL	ES	FR	HR	IT	CY	LV
LT	LU	HU	MT	NL	AT	PL
PT	RO	SI	SK	FI	SE	UK (NI)

PT

Informações de rádio

Barra de som

- Gama de frequências Bluetooth: 2400 - 2483,5 MHz
- Potência do transmissor Bluetooth: <13 dBm (EIRP)
- Rede Wi-Fi: IEEE 802.11 a/b/g/n/ac (2,4GHz/5GHz)
- Gama de frequências Wi-Fi 2,4G: 2412 - 2472 MHz
- Potência do transmissor Wi-Fi 2,4G: < 20 dBm (EIRP)
- Gama de frequências Wi-Fi 5G: 5,15 - 5,35 GHz, 5,470 - 5,725 GHz, 5,725 - 5,825 GHz
- Potência do transmissor Wi-Fi 5G: < 23 dBm (EIRP)
- Gama de frequências sem fios 2.4G: 2406 - 2474 MHz
- Potência do transmissor sem fios 2.4G: < 10 dBm (EIRP)

Informações de rádio

Subwoofer

- Gama de frequências: 2406 MHz - 2474 MHz
- Potência máxima (EIRP): 10dBm

Para dispositivo 5G WIFI

O dispositivo para funcionamento na banda 5150 - 5350 MHz destina-se apenas a utilização em interiores para reduzir o potencial de interferências nocivas nos sistemas móveis por satélite co-canal.

* O funcionamento de 5150 - 5350 MHz está restringido apenas à utilização em interiores.



BE	BG	CZ	DK	DE	EE	IE
EL	ES	FR	HR	IT	CY	LV
LT	LU	HU	MT	NL	AT	PL
PT	RO	SI	SK	FI	SE	UK (NI)

SR

Radio informacije

Audio

- Opseg Bluetooth frekvencije: 2400 - 2483,5 MHz
- Napajanje Bluetooth predajnika: <13 dBm (EIRP)
- Wi-Fi mreže IEEE 802.11 a/b/g/n/ac (2,4 GHz/5 GHz)
- 2,4G Wi-Fi Frekventni opseg: 2412 - 2472 MHz
- 2,4G Wi-Fi Snaga predajnika: < 20 dBm (EIRP)
- 5G Wi-Fi Frekventni opseg 5,15 - 5,35 GHz, 5,470 - 5,725 GHz, 5,725 - 5,825 GHz
- 5G Wi-Fi Snaga predajnika: < 23 dBm (EIRP)
- 2,4G Opseg bežične frekvencije: 2406 - 2474 MHz
- 2,4G Snaga bežičnog predajnika: <10 dBm (EIRP)

Radio informacije

Sabvufer

- Frekventni opseg: 2406MHz - 2474MHz
- Maksimalna snaga (EIRP): 10dBm

Za 5G WIFI Uređaje

Uređaji koji rade u bendu 5150 - 5350 MHz trebalo bi da se koriste samo u zatvorenom prostoru kako bi se smanjile potencijalno štetne smetnje za ko-kanalne mobilne satelitske sisteme.

* Bend 5150 - 5350 MHz je samo za upotrebu u zatvorenom prostoru.



BE	BG	CZ	DK	DE	EE	IE
EL	ES	FR	HR	IT	CY	LV
LT	LU	HU	MT	NL	AT	PL
PT	RO	SI	SK	FI	SE	UK (NI)

RO

Informații radio

Soundbar

- Gama de frecvență Bluetooth: 2400 – 2483,5 MHz
- Puterea transmisiilor Bluetooth: <13 dbm (EIRP)
- Rețea Wi-Fi: IEEE 802.11 a/b/g/n/ac (2,4GHz/5GHz)
- Gama de frecvență Wi-Fi 2,4G: 2412 – 2472 MHz
- Putere transmisiator Wi-Fi 2,4G: <20 dbm (EIRP)
- Gama de frecvență Wi-Fi 5G: 5,15 – 5,35 GHz, 5,470 – 5,725 GHz, 5,725 – 5,825 GHz
- Putere transmisiator Wi-Fi 5G: < 23 dbm (EIRP)
- Gama de frecvență wireless 2,4G: 2406 – 2474MHz
- Puterea transmisiatorului fără fir 2,4G: <10 dBm (EIRP)

Informații radio

Subwoofer

- Gamă de frecvență: 2406MHz-2474MHz
- Putere maximă (EIRP): 10dBm

Disponibil pentru dispozitive WIFI 5G

Echipamentele care funcționează în banda de 5150-5350 MHz sunt destinate utilizării în interior numai pentru a reduce potențialul de interferențe dăunătoare pentru sistemele mobile prin satelit oceanic.

* Funcționarea la 5150–5350MHz este limitată doar la utilizarea în interior.



BE	BG	CZ	DK	DE	EE	IE
EL	ES	FR	HR	IT	CY	LV
LT	LU	HU	MT	NL	AT	PL
PT	RO	SI	SK	FI	SE	UK (NI)

SK

Rádiové informácie

Zvuková lišta

- Frekvencijný rozsah Bluetooth: 2400 – 2483,5 MHz
- Výkon vysielateľa Bluetooth: <13 dBm (EIRP)
- Wi-Fi sieť: IEEE 802.11 a/b/g/n/ac (2,4 GHz/5 GHz)
- Frekvencijný rozsah 2,4G Wi-Fi: 2412 – 2472 MHz
- Výkon vysielateľa 2,4G Wi-Fi: < 20 dBm (EIRP)
- Frekvencijný rozsah 5G Wi-Fi: 5,15 – 5,35 GHz, 5,470 – 5,725 GHz, 5,725 – 5,825 GHz
- Výkon vysielateľa 5G Wi-Fi: < 23 dBm (EIRP)
- Bezdrôtový frekvencijný rozsah 2,4G: 2406 – 2474MHz
- Výkon bezdrôtového vysielateľa 2,4G: <10 dBm (EIRP)

Rádiové informácie

Subwoofer

- Frekvencijný rozsah: 2406MHz - 2474MHz
- Maximálny výkon (EIRP): 10dBm

K dispozícií pre 5G WIFI zariadenia

Zariadenia pracujúce v pásme 5150 - 5350 MHz sú určené na použitie vo vnútorných priestoroch iba na zníženie potenciálneho škodlivého rušenia spoločných mobilných satelitných systémov.

* Prevádzka na frekvencii 5150 - 5350 MHz je obmedzená len na použitie v interiéri.



BE	BG	CZ	DK	DE	EE	IE
EL	ES	FR	HR	IT	CY	LV
LT	LU	HU	MT	NL	AT	PL
PT	RO	SI	SK	FI	SE	UK (NI)

SL

Radjijske informacije

Zvočna vristica

- Frekvenčno območje Bluetooth: 2400 - 2483.5 MHz
- Moč oddajnika Bluetooth: <13 dBm (EIRP)
- Omrežje Wi-Fi: IEEE 802.11 a/b/g/n/ac (2,4 GHz/5GHz)
- 2,4G Wi-Fi Frekvenčno območje: 2412 - 2472 MHz
- 2,4G Wi-Fi Oddajnik moč: < 20 dBm (EIRP)
- Frekvenčno območje 5G Wi-Fi: 5,15 - 5,35 GHz, 5,470 - 5,725 GHz, 5,725 - 5,825 GHz
- 5G Wi-Fi Oddajnik moč: < 23 dBm (EIRP)
- 2,4G Brežično frekvenčno območje: 2406 - 2474MHz
- 2,4G Moč brezžičnega oddajnika: <10 dBm (EIRP)

Radjijske informacije

Globalkotonec

- Frekvenčno območje: 2406MHz- 2474MHz
- Največja moč (EIRP): 10dBm

Na voljo za naprave 5G WIFI

Oprema, ki deluje v frekvenčnem pasu 5150 - 5350 MHz, je namenjena uporabi v zaprtih prostorih samo za zmanjšanje možnosti motenja mobilnih satelitskih sistemov, ki delujejo na istih kanalih.

* Delovanje pri 5150 - 5350 MHz je omejeno samo na uporabo v zaprtih prostorih.

	BE	BG	CZ	DK	DE	EE	IE
	EL	ES	FR	HR	IT	CY	LV
	LT	LU	HU	MT	NL	AT	PL
	PT	RO	SI	SK	FI	SE	UK (NI)

TR

Radjo bilgileri

Ses çubuğu

- Bluetooth frekans aralığı: 2400 – 2483.5 MHz
- Bluetooth verici gücü: <13 dBm (EIRP)
- Wi-Fi ağı: IEEE 802.11 a/b/g/n/ac (2,4 GHz/5 GHz)
- 2,4G Wi-Fi frekans aralığı: 2412 - 2472 MHz
- 2,4G Wi-Fi verici gücü: < 20 dBm (EIRP)
- 5G Wi-Fi frekans aralığı: 5,15 - 5,35 GHz, 5,470 - 5,725 GHz, 5,725 - 5,825 GHz
- 5G Wi-Fi Verici Gücü: < 23 dBm (EIRP)
- 2,4G Kablosuz Frekans Aralığı: 2406 - 2474MHz
- 2,4G kablosuz verici gücü: <10 dBm (EIRP)

Radjo bilgileri

Subwoofer (Subwoofer)

- Frekans aralığı: 2406MHz-2474MHz
- Maksimum güç (EIRP): 10dBm

5G WIFI cihazları için kullanılabılır

5150-5350 MHz bandında çalışan ekipman, ortak kanalı mobil uydu sistemlerine zararı paraziti olasılığı azaltmak için yalnızca iç mekan kullanımı için tasarlanmıştır.

* 5150-5350MHz'de çalışma yalnızca iç mekan kullanımıyla sınırlıdır.

	BE	BG	CZ	DK	DE	EE	IE
	EL	ES	FR	HR	IT	CY	LV
	LT	LU	HU	MT	NL	AT	PL
	PT	RO	SI	SK	FI	SE	UK (NI)

ES

Información de radio

Barra de Sonido

- Rango de frecuencia Bluetooth: 2400 - 2483.5 MHz
- Potencia del transmisor Bluetooth: <13 dBm (EIRP)
- Redes Wi-Fi: IEEE 802.11 a/b/g/n/ac (2,4GHz/5GHz)
- Rango de frecuencia Wi-Fi 2.4G: 2412 - 2472 MHz
- Potencia del transmisor Wi-Fi 2.4G: < 20 dBm (EIRP)
- Rango de frecuencia Wi-Fi 5G: 5,15 - 5,35 GHz, 5,470 - 5,725 GHz, 5,725 - 5,825 GHz
- Potencia del transmisor Wi-Fi 5G: < 23 dBm (EIRP)
- Rango de frecuencia inalámbrica 2.4G: 2406 - 2474MHz
- Potencia del transmisor inalámbrico 2.4G: <10 dBm (EIRP)

Información de radio

Subwoofer

- Rango de frecuencia: 2406MHz-2474MHz
- Potencia máxima (EIRP): 10dBm

Para dispositivos WIFI 5G

El dispositivo que funciona en la banda de 5150 a -5350 MHz es únicamente para uso en interiores con el fin de reducir las posibles interferencias perjudiciales para los sistemas móviles por satélite cocanal.
* El funcionamiento de 5150-5350MHz está restringido únicamente al uso en interiores.

	BE	BG	CZ	DK	DE	EE	IE
	EL	ES	FR	HR	IT	CY	LV
	LT	LU	HU	MT	NL	AT	PL
	PT	RO	SI	SK	FI	SE	UK (NI)

UA

Інформація про радіо

Сабвуфер

- Діапазон частот Bluetooth: 2400 – 2483.5 МГц
- Потужність передавача Bluetooth: <13 дБм (EIRP)
- Мережа Wi-Fi: IEEE 802.11 a/b/g/n/ac (2,4 ГГц/5 ГГц)
- Діапазон частот 2.4G Wi-Fi: 2412 - 2472 МГц
- Потужність передавача 2.4G Wi-Fi: < 20 дБм (EIRP)
- Діапазон частот 5G Wi-Fi: 5,15 - 5,35 ГГц, 5,470 - 5,725 ГГц, 5,725 - 5,825 ГГц
- Потужність передавача 5G Wi-Fi: < 23 дБм (EIRP)
- Діапазон бездротових частот 2.4G: 2406 - 2474 МГц
- Потужність бездротового передавача 2.4G: <10 дБм (EIRP)

Інформація про радіо

Сабвуфер

- Діапазон частот: 2406 МГц-2474 МГц
- Максимальна потужність (EIRP): 10 дБм

Доступно для пристроїв 5G WIFI

Обладнання, що працює в діапазоні 5150-5350 МГц, призначене лише для використання всередині приміщень, щоб зменшити потенційні шкідливі перешкоди для мобільних супутникових систем зі спільним каналом.

* Робота на частоті 5150-5350 МГц обмежена лише внутрішнім використанням.

	BE	BG	CZ	DK	DE	EE	IE
	EL	ES	FR	HR	IT	CY	LV
	LT	LU	HU	MT	NL	AT	PL
	PT	RO	SI	SK	FI	SE	UK (NI)

SV

Radioinformation

Soundbar

- Bluetooth-frekvensområde: 2400 - 2483.5 MHz
- Bluetooth-sändarens effekt: <13 dBm (EIRP)
- Wi-Fi-nätverk: IEEE 802.11 a/b/g/n/ac (2,4 GHz/5 GHz)
- 2,4G Wi-Fi-frekvensområde: 2412 - 2472 MHz
- 2,4G Wi-Fi-sändarens effekt: < 20 dBm (EIRP)
- 5G Wi-Fi-frekvensområde: 5,15 - 5,35 GHz, 5,470 - 5,725 GHz, 5,725 - 5,825 GHz
- 5G Wi-Fi-sändareffekt: < 23 dBm (EIRP)
- 2,4G trådlöst frekvensområde: 2406 - 2474MHz
- 2,4G trådlös sändareffekt: <10 dBm (EIRP)

Radioinformation

Subwoofer

- Frekvensområde: 2406MHz-2474MHz
- Maximal effekt (EIRP): 10dBm

Tillgänglig för 5G WIFI-enheter

Utrustning som arbetar i 5150-5350 MHz-bandet är endast avsedd för inomhusbruk för att minska risken för skadlig störning av mobila satellitsystem i samkanal.
* Drott vid 5150-5350MHz är begränsad till endast inomhusbruk.

	BE	BG	CZ	DK	DE	EE	IE
	EL	ES	FR	HR	IT	CY	LV
	LT	LU	HU	MT	NL	AT	PL
	PT	RO	SI	SK	FI	SE	UK (NI)

Statement of Compliance:

2023 No. 1007 The Product Security and Telecommunications Infrastructure (Security Requirements for Relevant Connectable Products) Regulations 2023

The product is in compliance with the following standard(s) or normative document(s):

- ETSI EN 303 645 V2.1.1:2020-06
- Provision 5.1-1
- Provision 5.1-2
- Provision 5.2-1
- Provision 5.3-13

The full text of the UK declaration of conformity is available at the following internet address: www.tcl.com.

Choose the model name and go to DOWNLOADS.

DO NOT RETURN TO STORE

**WE ARE
READY TO
HELP** contact us first
with any questions



TCL SUPPORT:
www.tcl.com



**TAKE CARE WHEN
REMOVING THE SOUND BAR**