

Z120 COMPACT STEREO SPEAKERS

Complete Setup Guide

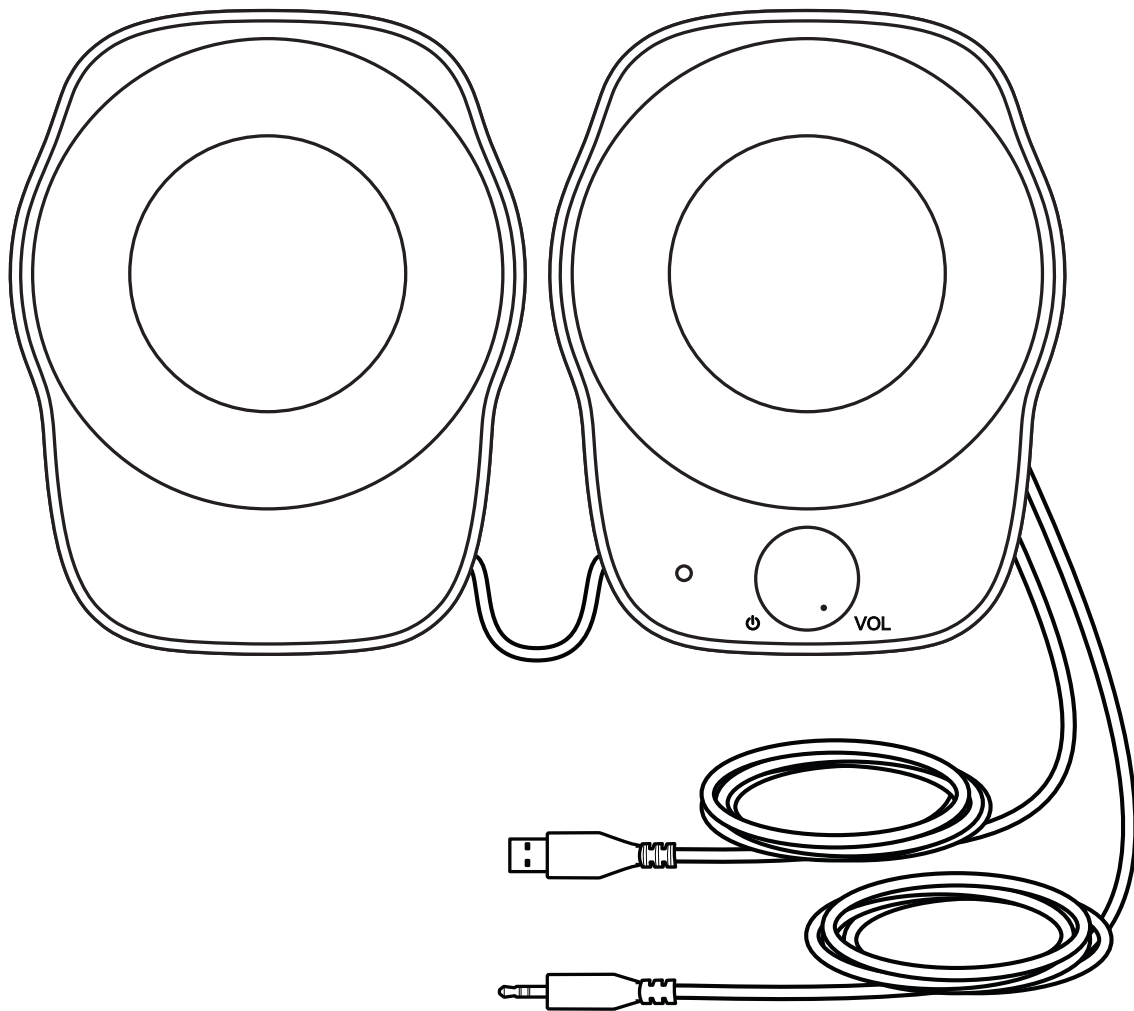

logitech®

CONTENTS

English	3	Česká verze	48
Deutsch	6	Slovenčina	51
Français	9	Українська	54
Italiano	12	Eesti	57
Español	15	Latviski	60
Português	18	Lietuvių	63
Nederlands	21	Български	66
Svenska	24	Hrvatski	69
Dansk	27	Srpski	72
Norsk	30	Slovenščina	75
Suomi	33	Română	78
Ελληνικά	36	Türkçe	81
По-русски	39	84 العربية	
Po polsku	42	87. עברית	
Magyar	45		

KNOW YOUR PRODUCT

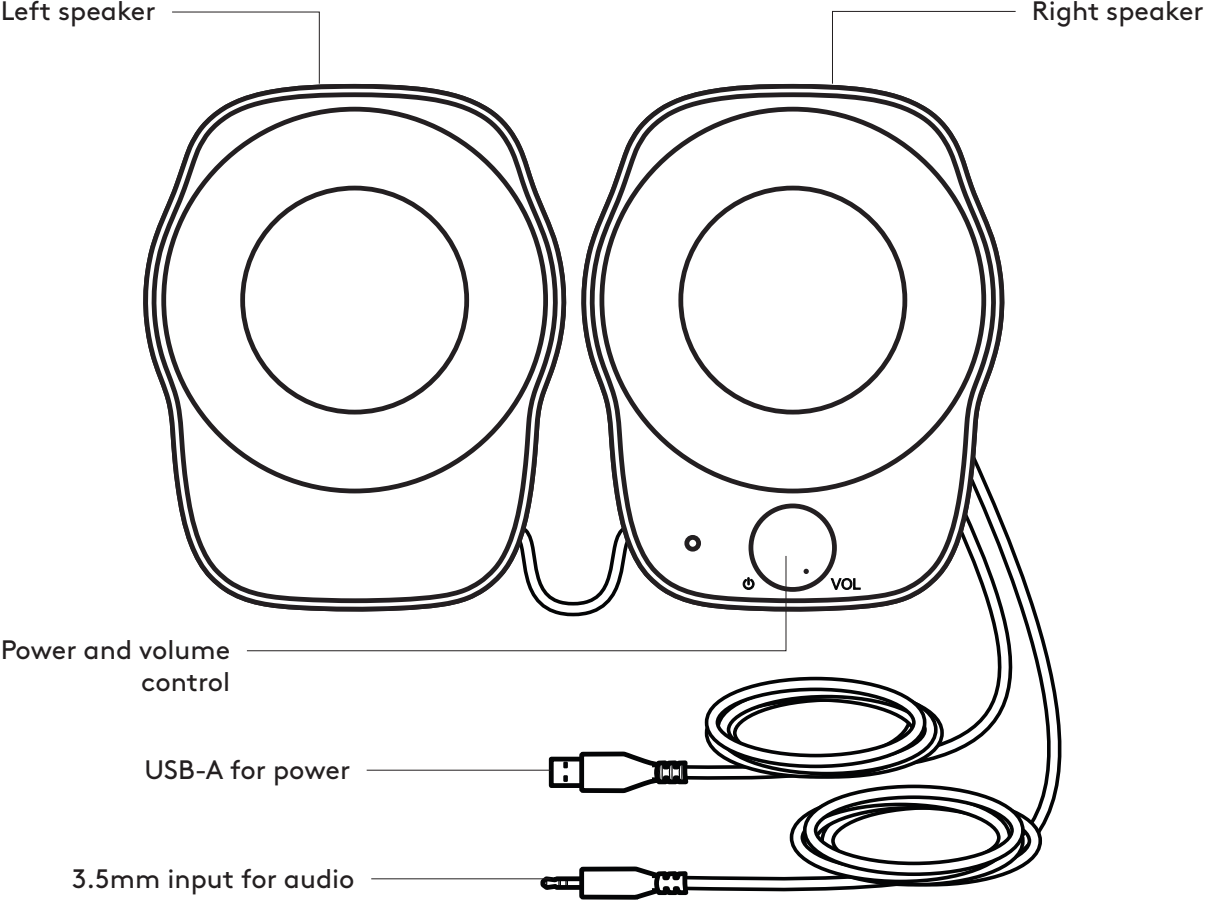
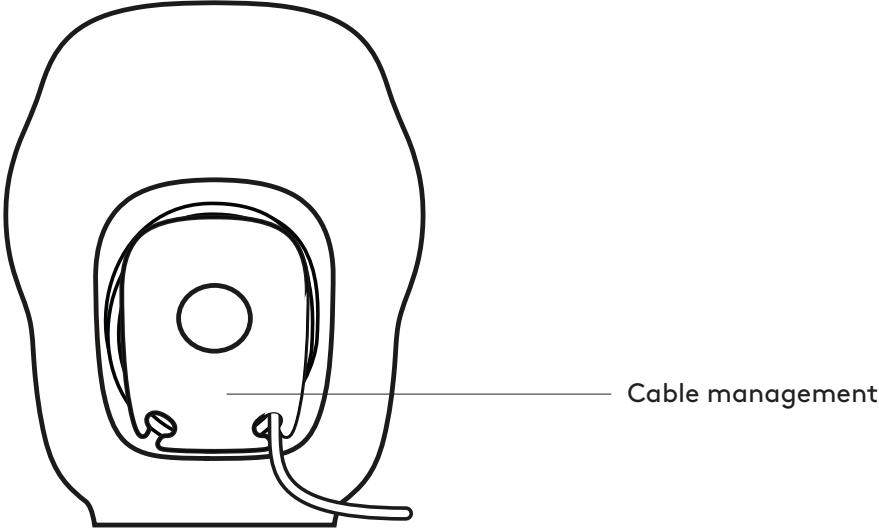

CONNECT THE SPEAKERS

1. Plug the USB-A plug into the USB-A port on your computer for power.
2. Plug the 3.5mm connector into the 3.5mm jack on your audio device.
3. Turn the speaker on using the power knob.

1

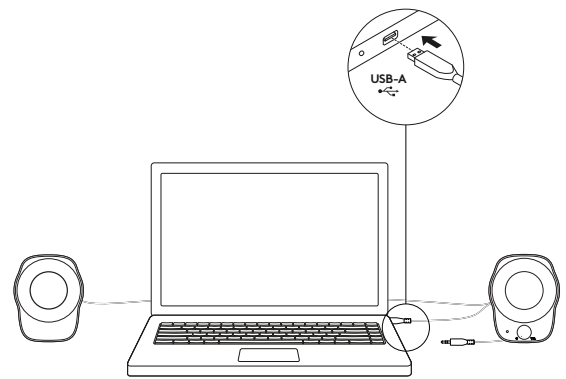

2

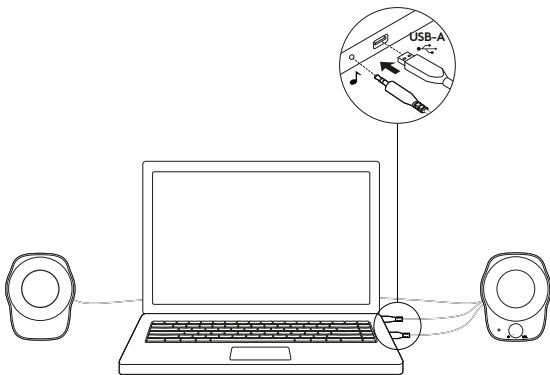

3

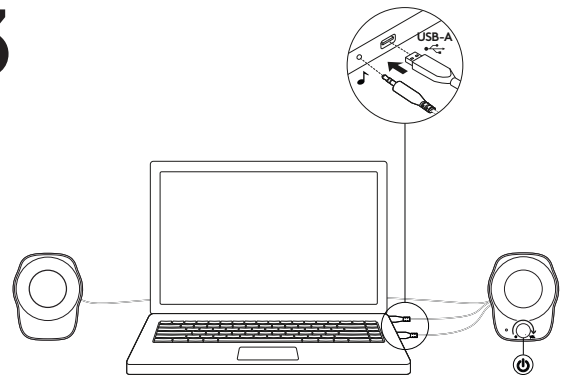

ADJUST THE VOLUME

Increase (or decrease) the volume of speakers by rotating the volume control knob clockwise (counter-clockwise) on the right speaker.

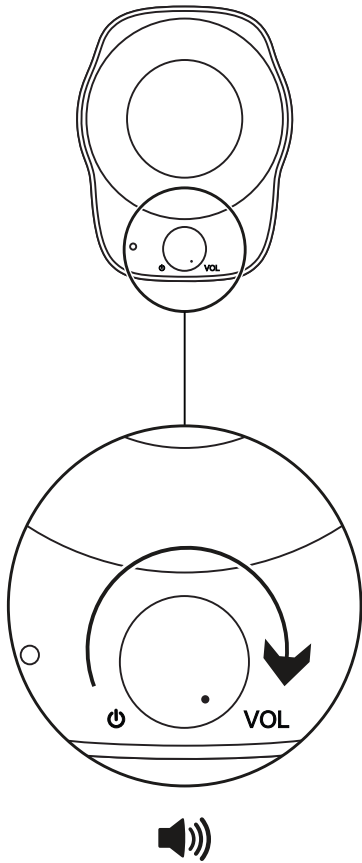

CABLE MANAGEMENT

Wind up extra cable length inside convenient wells behind each speaker.

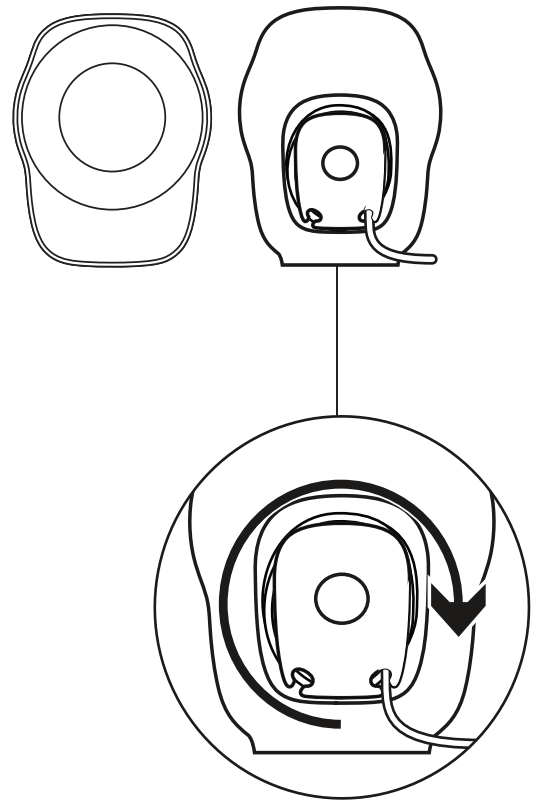

www.logitech.com/support/Z120

PRODUKT AUF EINEN BLICK

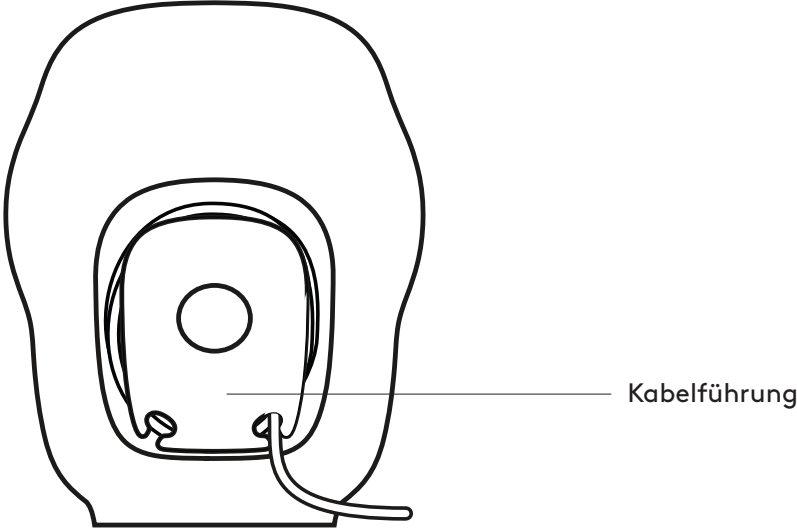

Linker Lautsprecher

Rechter Lautsprecher

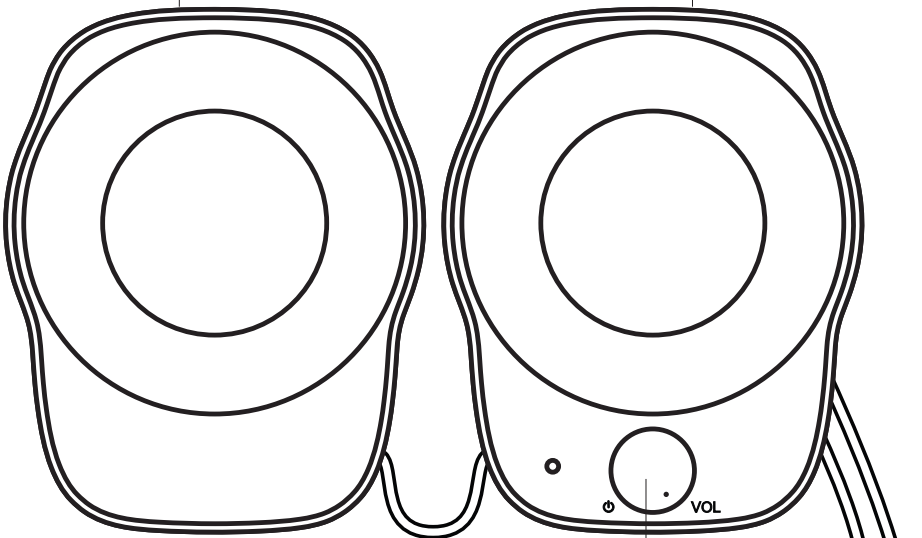

Ein/Aus-Schalter
und Lautstärkereger

USB-A für Stromversorgung

3,5-mm-Eingang (für Audio)

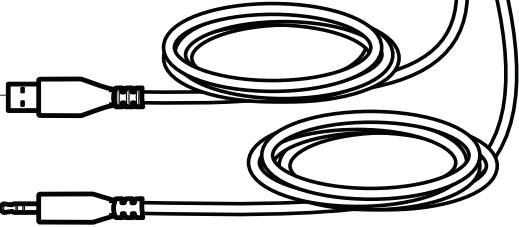

VERBINDEN DER LAUTSPRECHER

1. Schließen Sie für die Stromversorgung das USB-A-Kabel am USB-A-Anschluss an Ihrem Computer an.
2. Schließen Sie den 3,5-mm-Stecker an der 3,5-mm-Buchse an Ihrem Audiogerät an.
3. Schalten Sie den Lautsprecher mit dem Ein/Aus-Schalter ein.

1

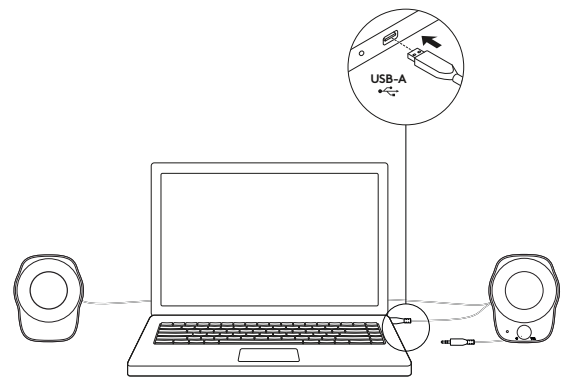

2

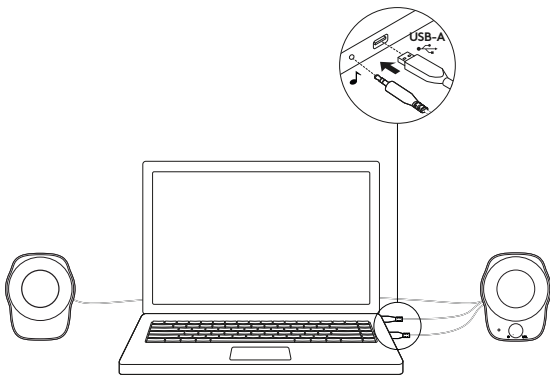

3

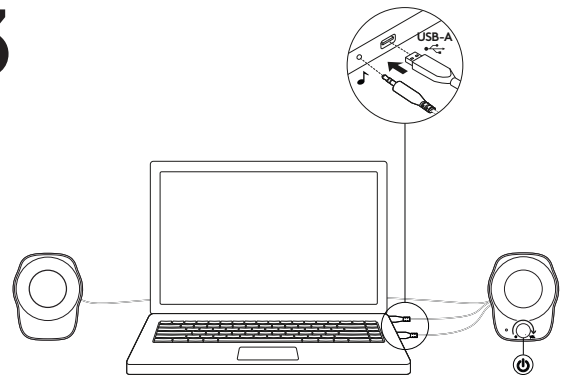

ANPASSEN DER LAUTSTÄRKE

Erhöhen (oder verringern) Sie die Lautstärke der Lautsprecher durch Drehen des Lautstärkereglers am rechten Lautsprecher im Uhrzeigersinn (bzw. gegen den Uhrzeigersinn).

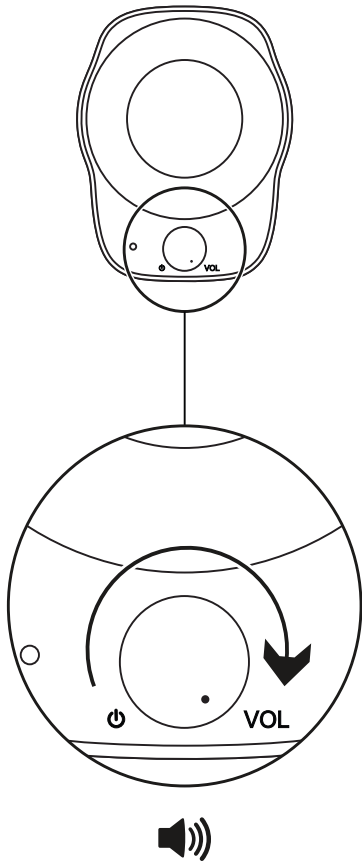

KABELFÜHRUNG

Der nicht benötigte Teil des Kabels lässt sich in praktischen Vertiefungen hinter jedem Lautsprecher aufwickeln.

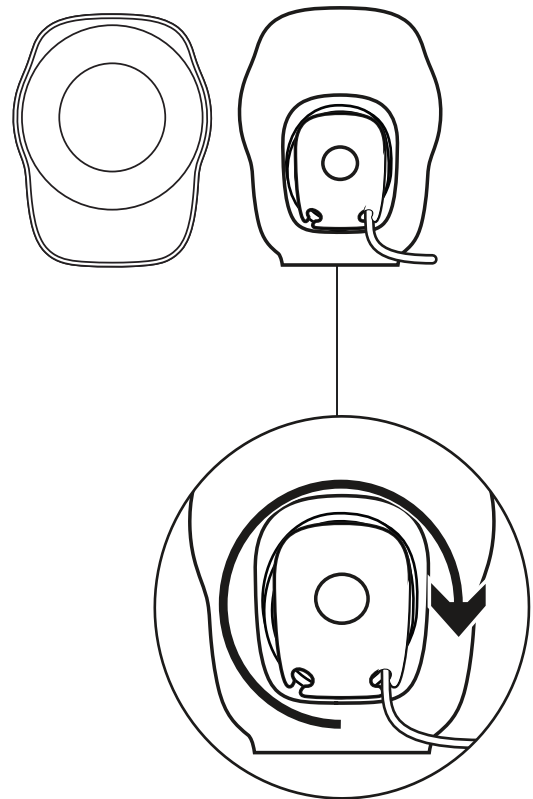

www.logitech.com/support/Z120

PRÉSENTATION DU PRODUIT

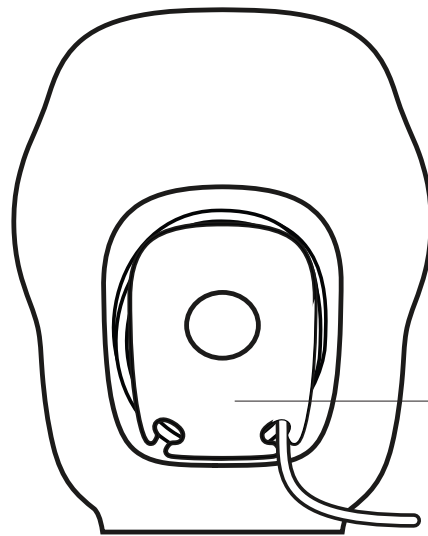

Rangement des câbles

Haut-parleur gauche

Haut-parleur droit

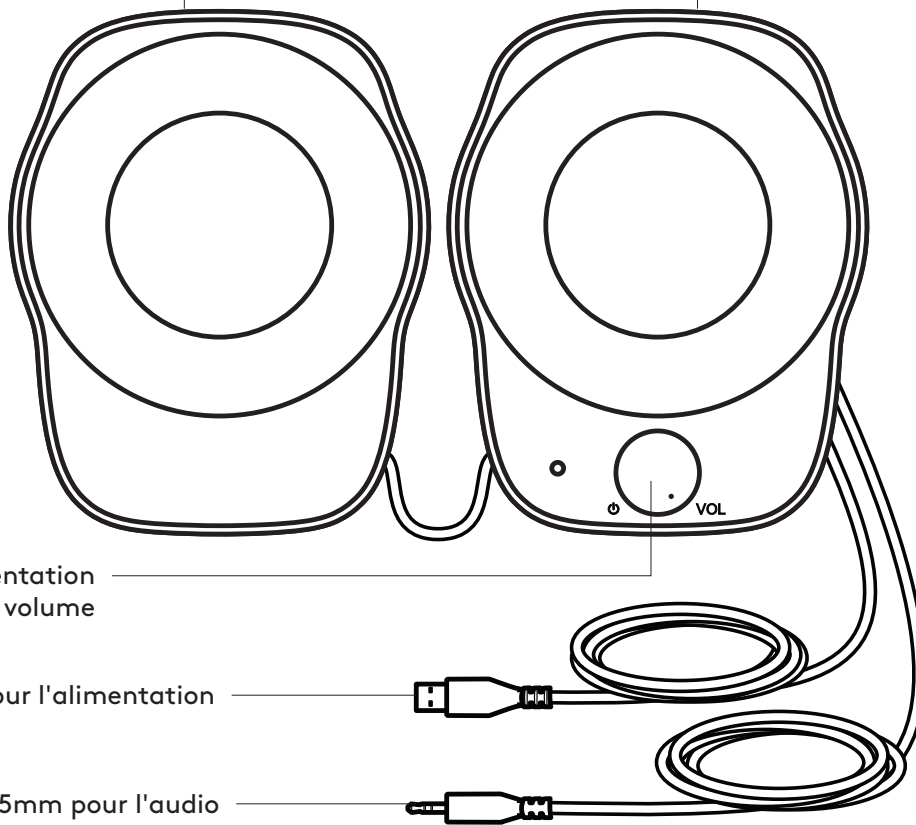

Bouton d'alimentation
et de volume

USB-A pour l'alimentation

Entrée 3,5mm pour l'audio

CONNEXION DES HAUT-PARLEURS

1. Branchez l'extrémité USB-A au port USB-A de votre ordinateur pour l'alimentation.
2. Branchez le connecteur 3,5mm à la prise jack 3,5mm de votre dispositif audio.
3. Allumez votre haut-parleur en utilisant le bouton d'alimentation.

1

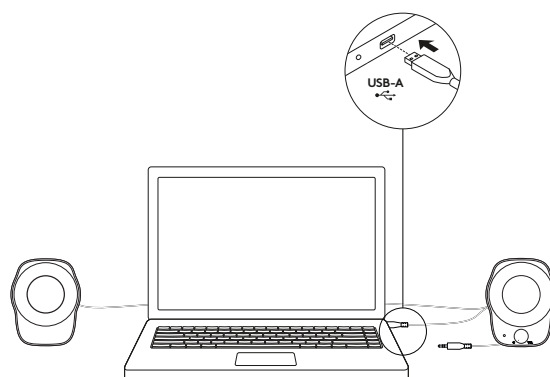

2

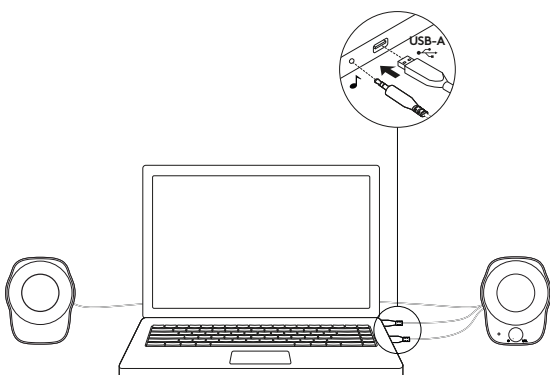

3

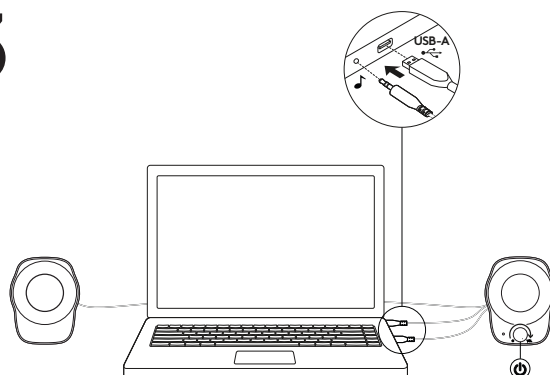

AJUSTEMENT DU VOLUME

Augmentez (ou baissez) le volume des haut-parleurs en faisant tourner la molette de contrôle du volume dans le sens horaire (antihoraire) sur le haut-parleur droit.

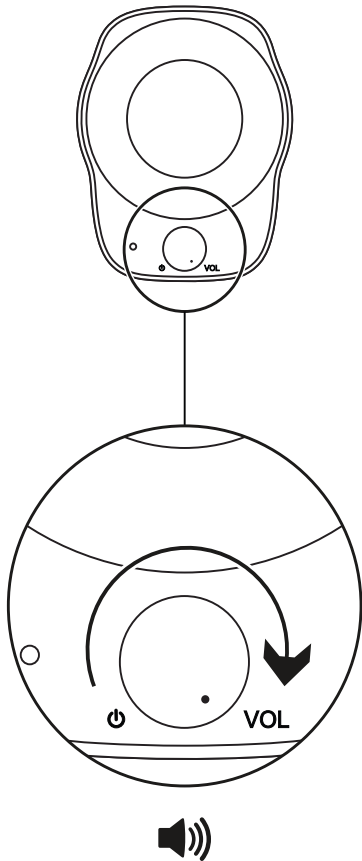

RANGEMENT DES CÂBLES

Enroulez la longueur restante du câble dans des compartiments pratiques prévus à cet effet derrière chaque haut-parleur.

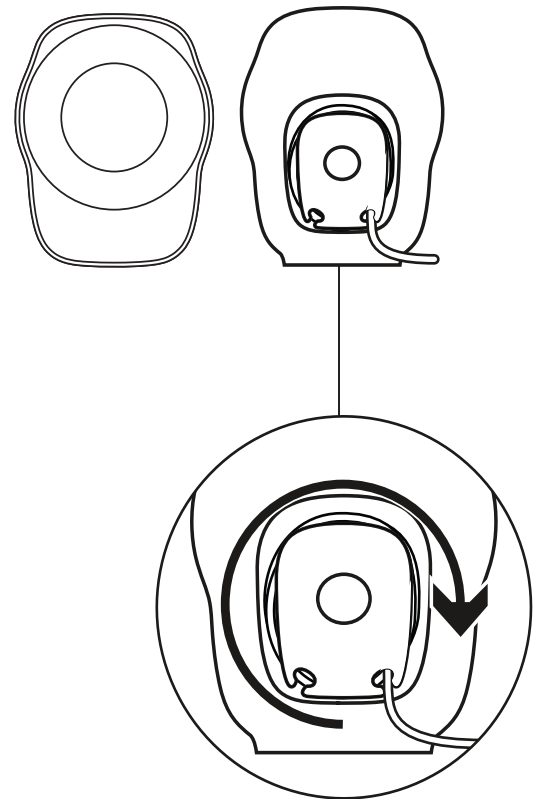

www.logitech.com/support/Z120

PANORAMICA DEL PRODOTTO

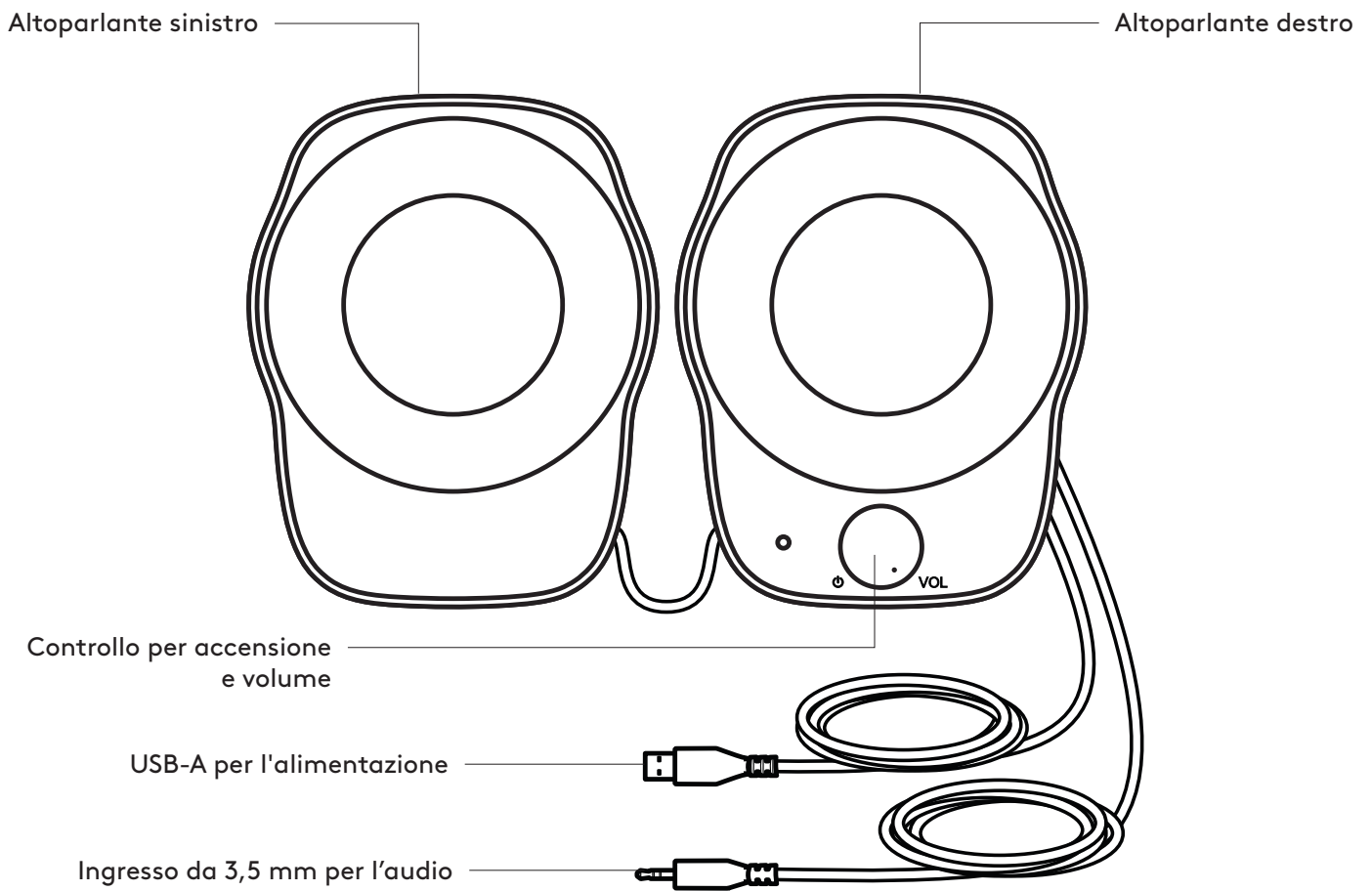
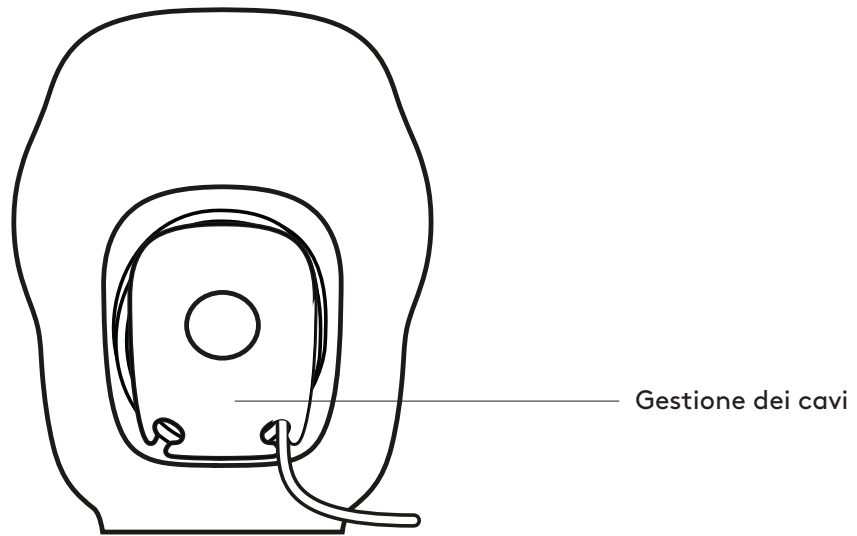

CONNESSIONE DEGLI ALTOPARLANTI

1. Inserire il connettore USB-A nella porta USB-A del computer per l'alimentazione.
2. Inserire il connettore da 3,5 mm nell'ingresso da 3,5 mm sul dispositivo audio.
3. Accendere l'altoparlante utilizzando la manopola di accensione.

1

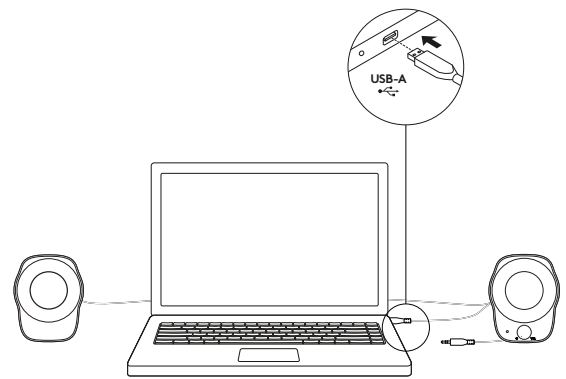

2

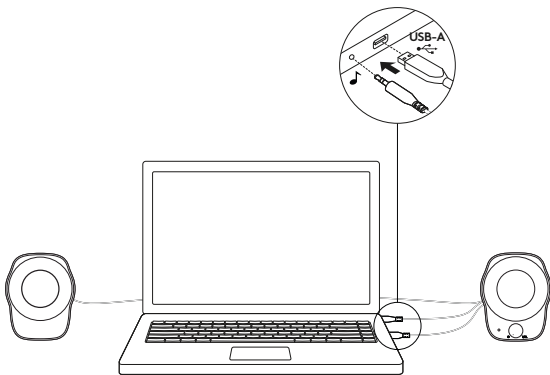

3

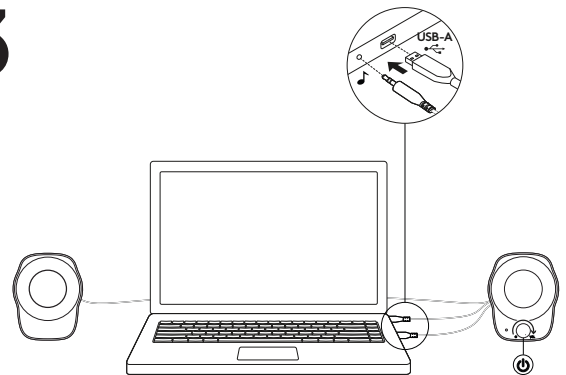

REGOLAZIONE DEL VOLUME

Aumentare o ridurre il volume degli altoparlanti ruotando rispettivamente in senso orario o antiorario la manopola di controllo del volume posta sull'altoparlante destro.

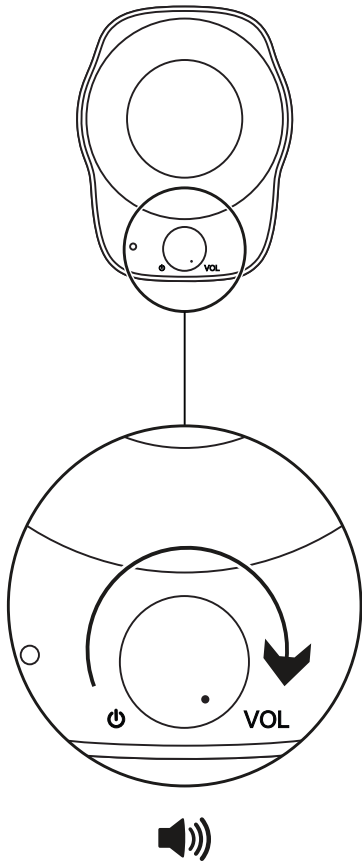

GESTIONE DEI CAVI

Avvolgere i cavi all'interno dei comodi incavi dietro ogni altoparlante.

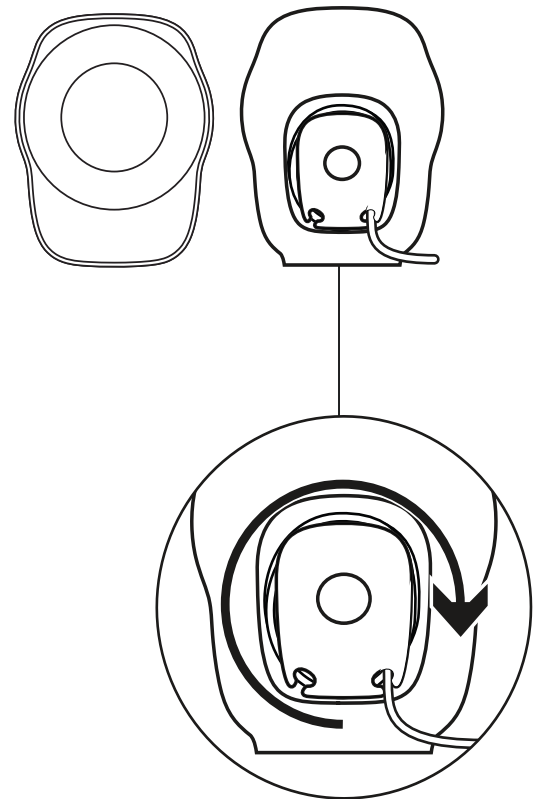

www.logitech.com/support/Z120

COMPONENTES DEL PRODUCTO

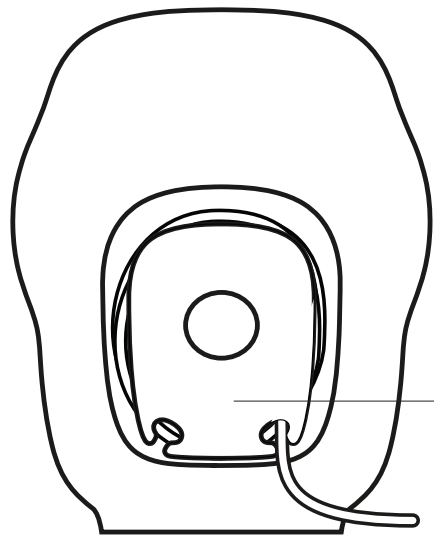

Distribución de cables

Altavoz izquierdo

Altavoz derecho

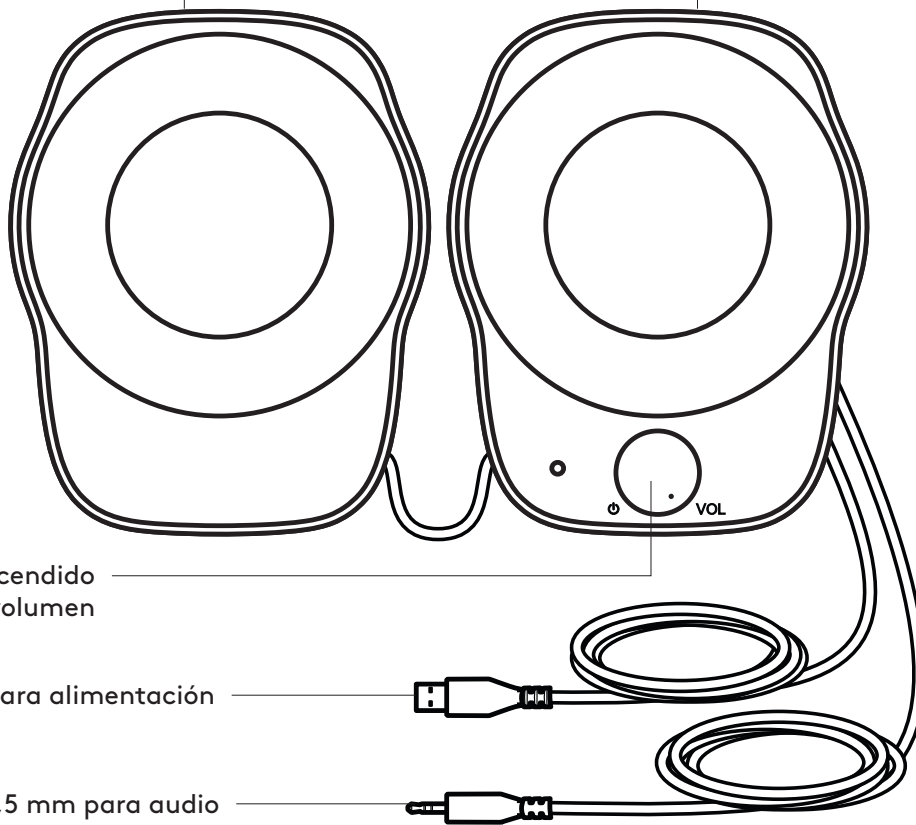

Control de encendido y volumen

USB-A para alimentación

Entrada de 3,5 mm para audio

CONECTA LOS ALTAVOCES

1. Conecta el extremo USB-A al puerto USB-A del ordenador para alimentación.
2. Conecta el conector de 3,5 mm a la entrada de 3,5 mm del dispositivo de audio.
3. Enciende el altavoz mediante el control giratorio de encendido.

1

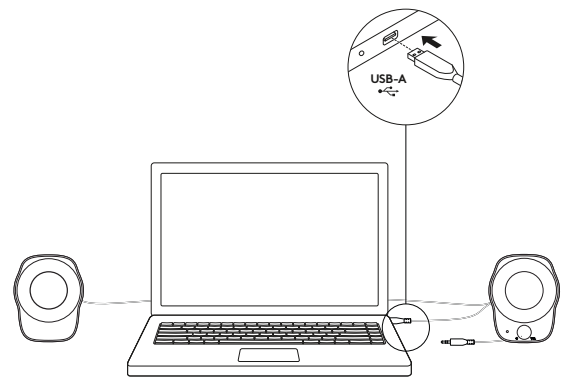

2

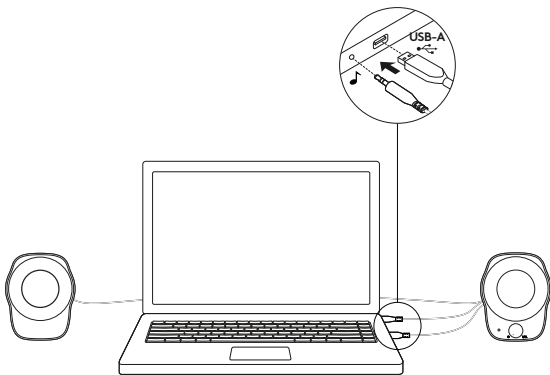

3

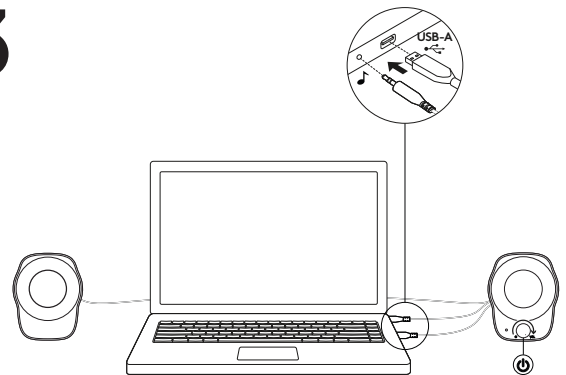

AJUSTA EL VOLUMEN

Aumenta (o reduce) el volumen de los altavoces girando el control de volumen en el sentido de las agujas del reloj (o en sentido contrario) en el altavoz derecho.

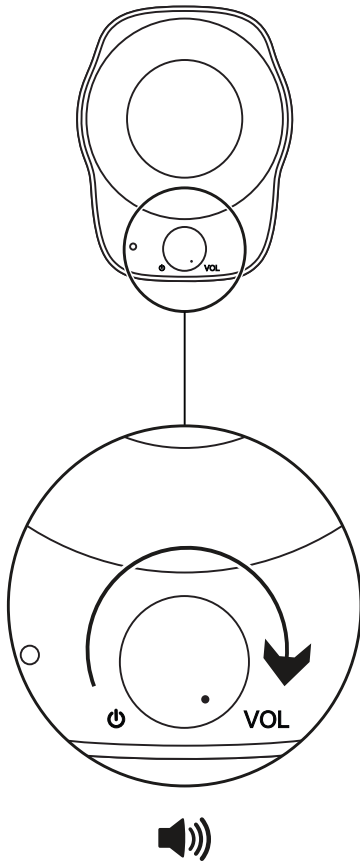

DISTRIBUCIÓN DE CABLES

La longitud de cable sobrante se puede enrollar convenientemente en la parte posterior de los altavoces.

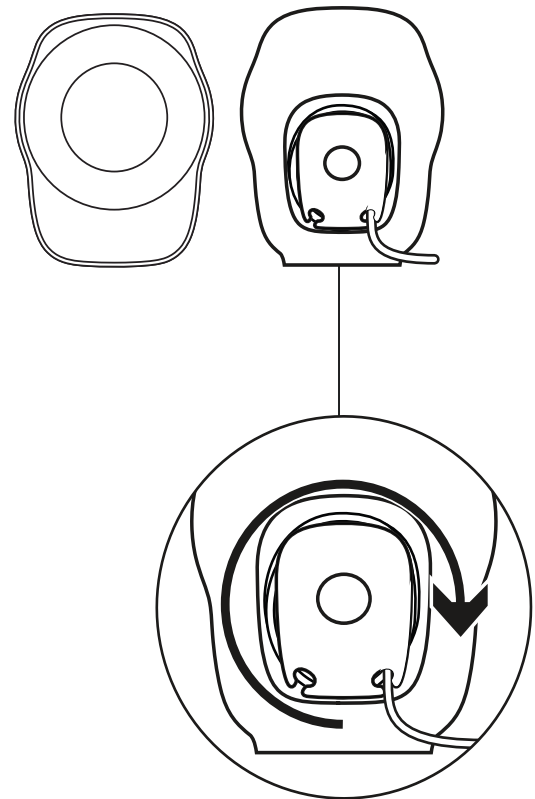

www.logitech.com/support/Z120

CONHEÇA O SEU PRODUTO

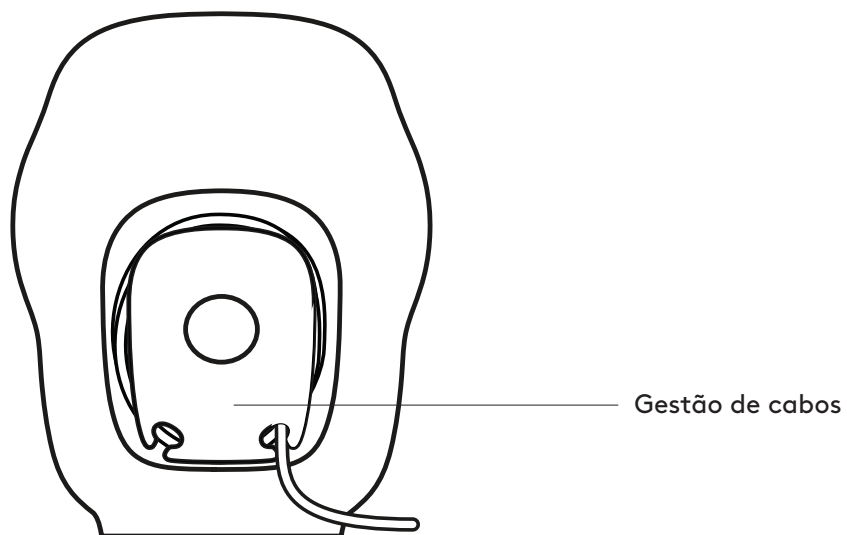

Altifalante esquerdo

Altifalante direito

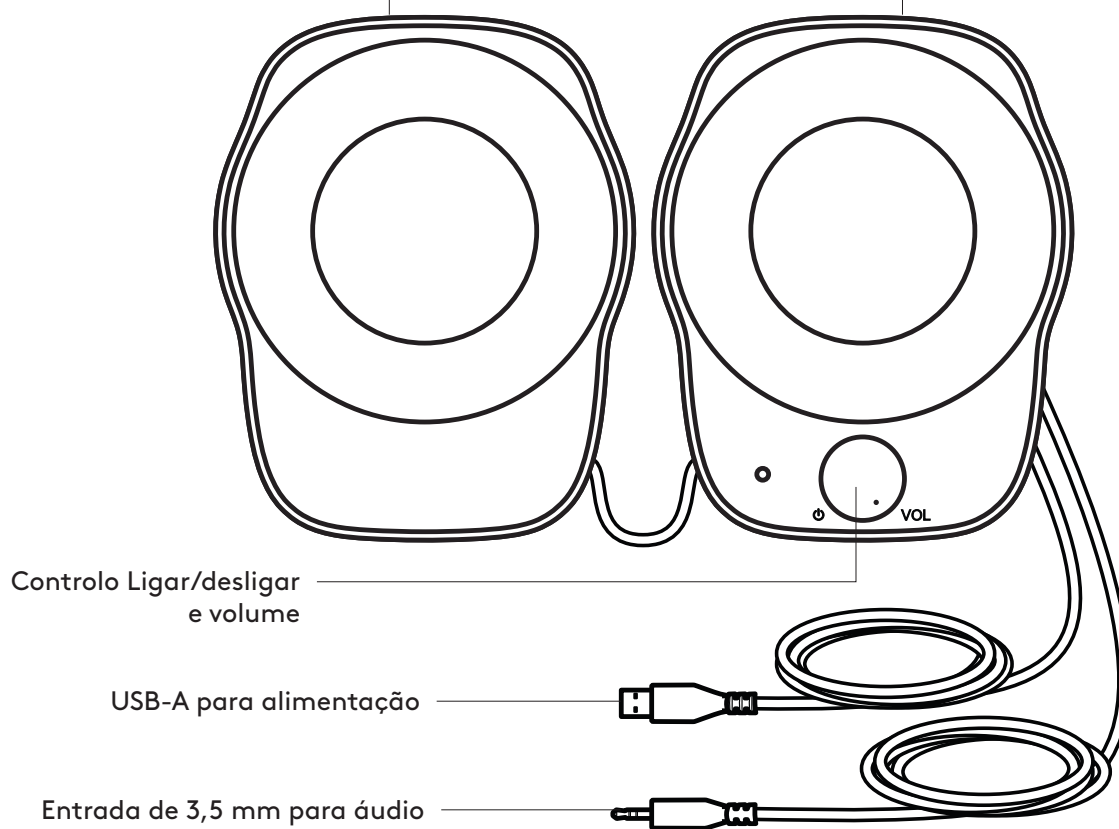

LIGAR OS ALTIFALANTES

1. Ligue a ficha USB-A a uma porta USB-A no seu computador para alimentação.
2. Ligue o conector de 3,5 mm na tomada de 3,5 mm do seu dispositivo de áudio.
3. Ligue o altifalante no botão Ligar/desligar.

1

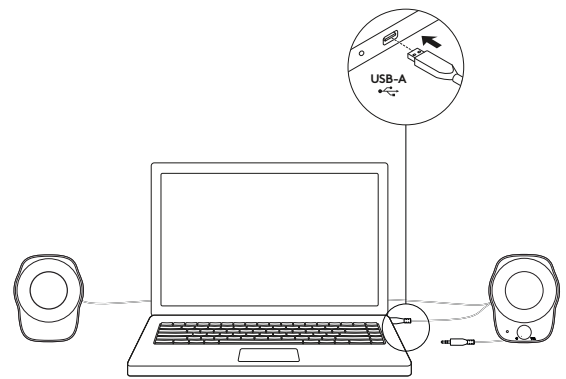

2

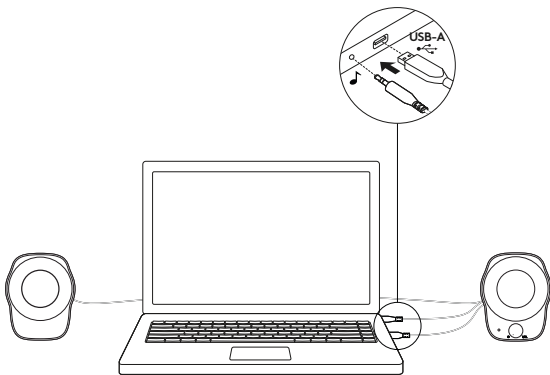

3

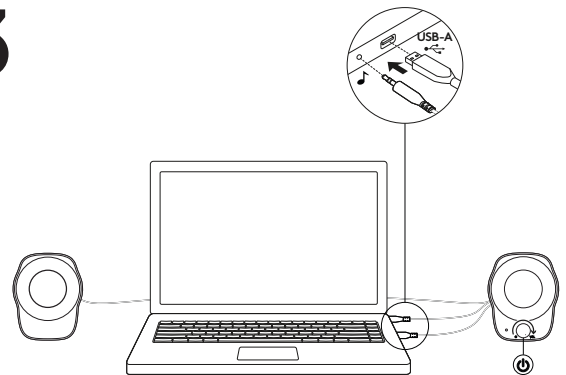

AJUSTAR O VOLUME

Aumente (ou diminua) o volume dos altifalantes rodando o botão de controlo do volume no sentido dos ponteiros do relógio (ou no sentido contrário) no altifalante direito.

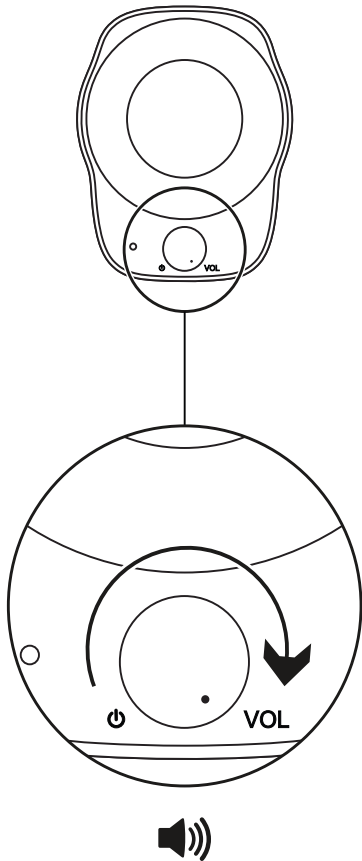

GESTÃO DE CABOS

Enrole a extensão de cabo restante dentro dos respectivos espaços atrás de cada altifalante.

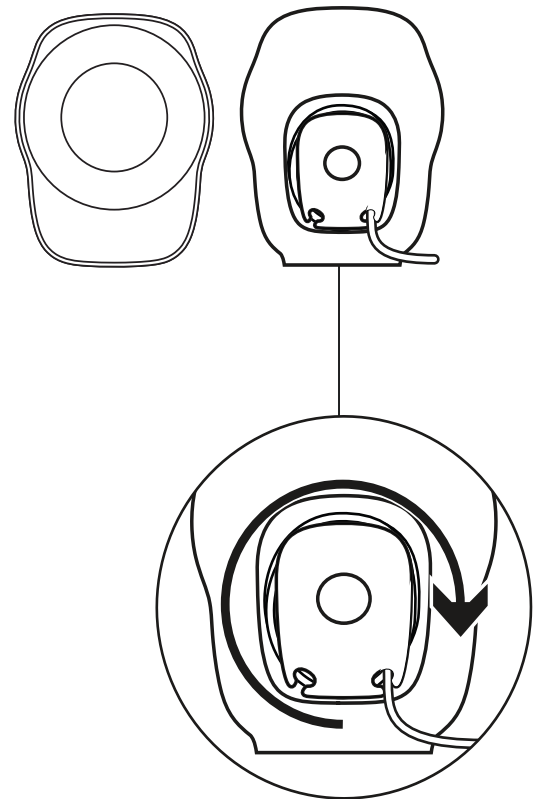

www.logitech.com/support/Z120

KEN JE PRODUCT

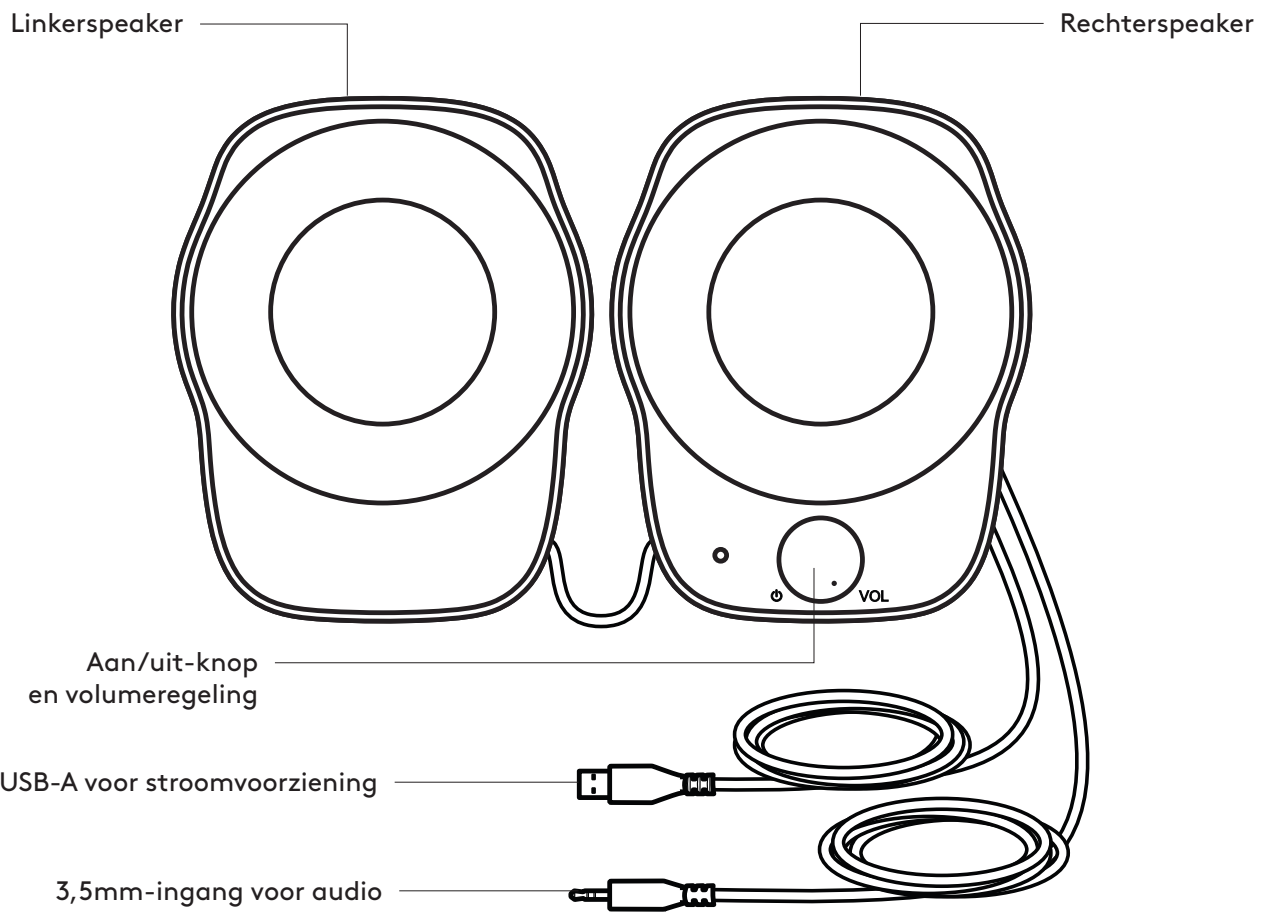
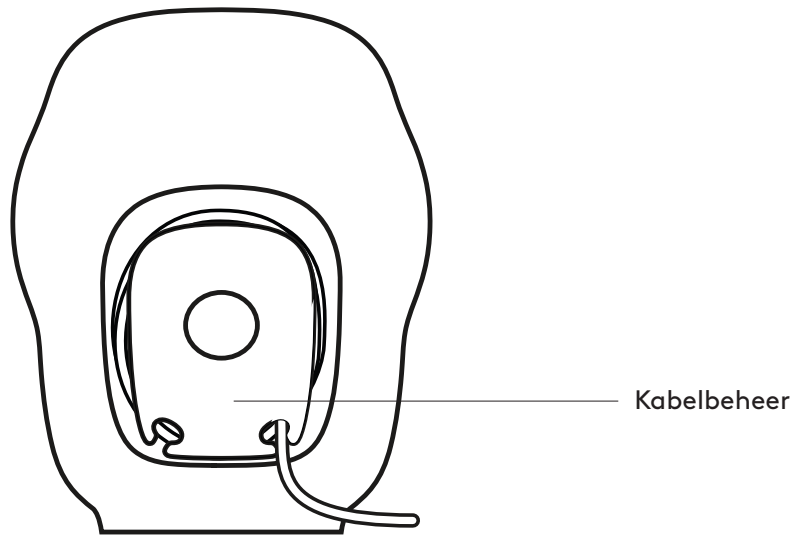

DE SPEAKERS AANSLUITEN

1. Sluit de USB-A-stekker aan op de USB-A-poort van je computer voor stroomvoorziening.
2. Sluit de 3,5mm-connector aan op de 3,5mm-ingang van je audioapparaat.
3. Zet de speaker aan met de aan/uit-knop.

1

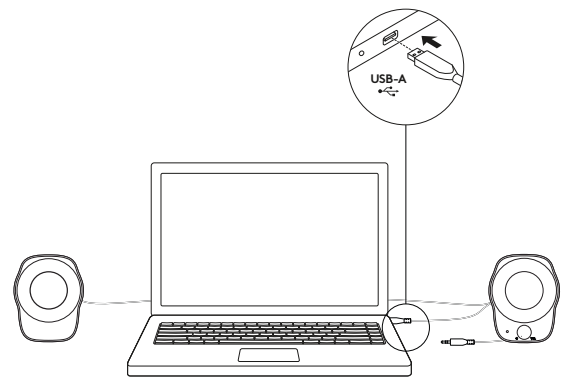

2

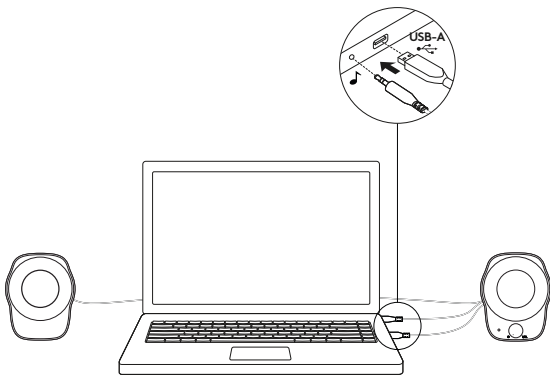

3

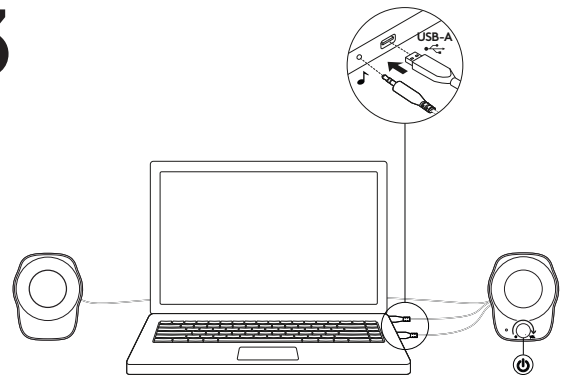

HET VOLUME AANPASSEN

Verhoog (of verlaag) het volume van speakers door de volumeknop op de rechterspaker met de klok mee (of tegen de klok in) te draaien.

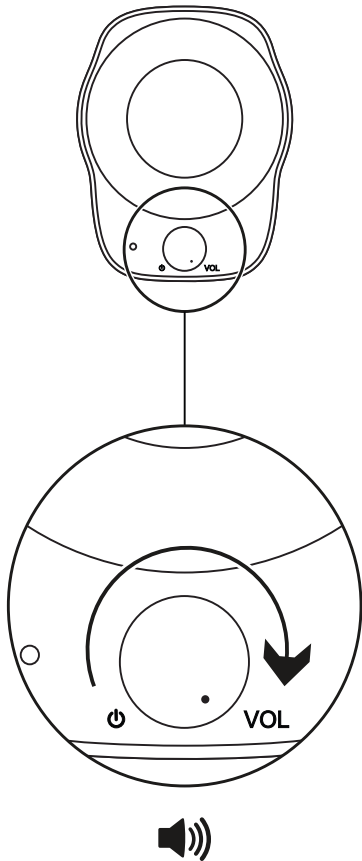

KABELBEHEER

Als de kabels te lang zijn, kun je ze oprollen en opbergen in de handige inkepingen aan de achterkant van de speakers.

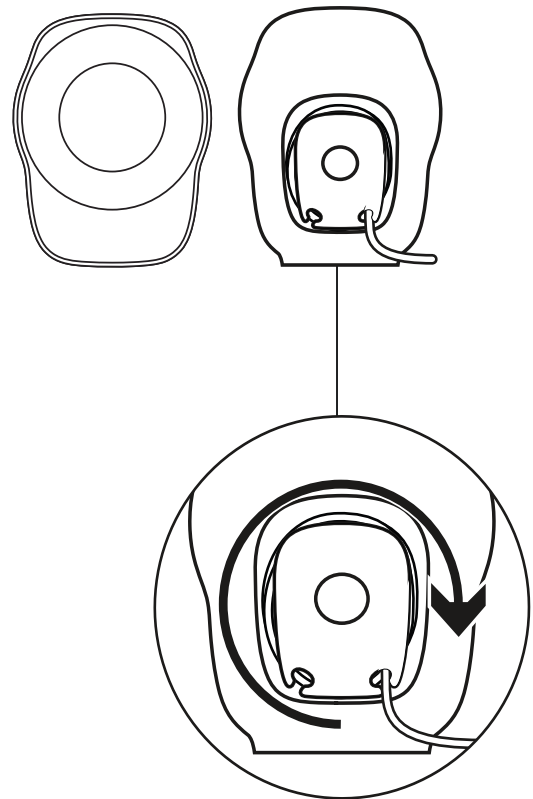

www.logitech.com/support/Z120

PRODUKTÖVERSIKT

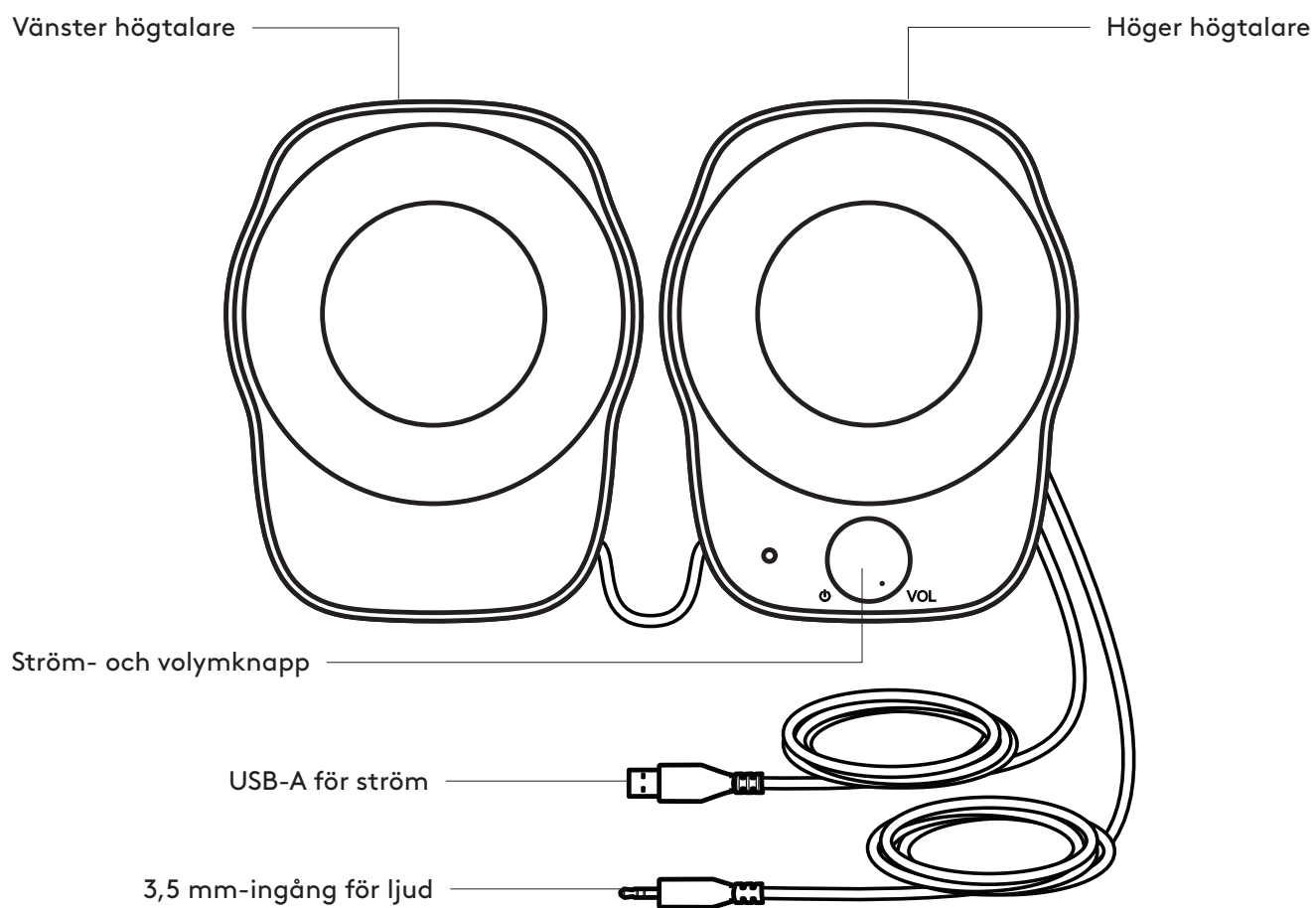
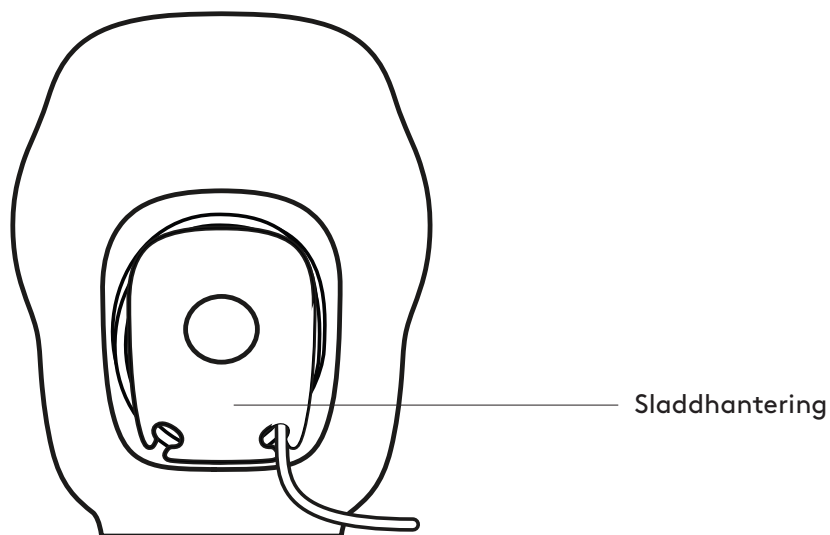

ANSLUTA HÖGTALARNA

1. Anslut USB-A-kontakten till USB-A-porten på datorn för strömförsörjning.
2. Anslut 3,5 mm-kontakten till 3,5 mm-ingången på ljudenheten.
3. Slå på högtalaren med strömbrytaren.

1

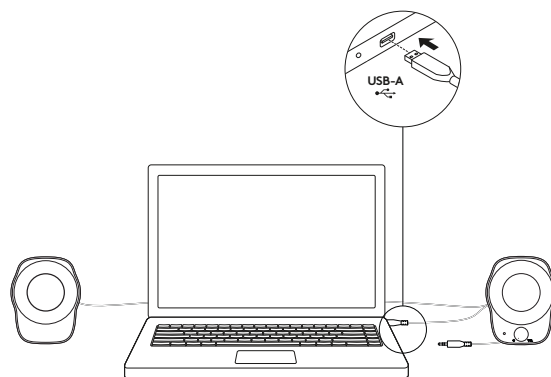

2

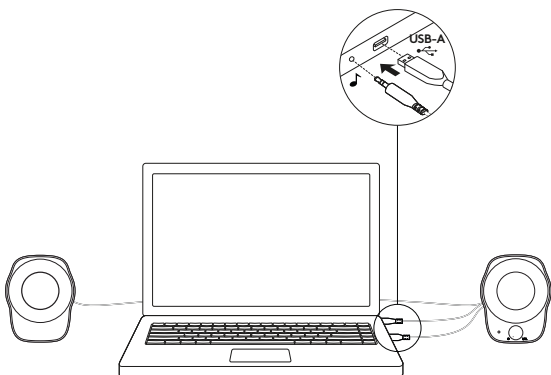

3

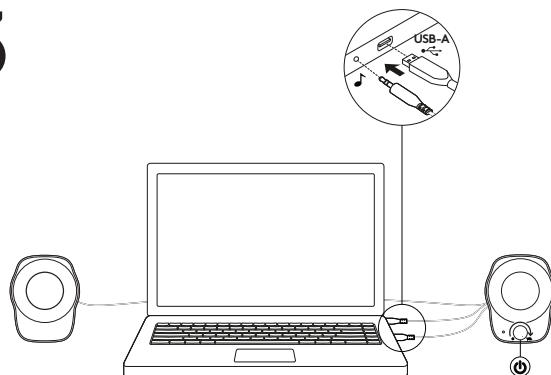

JUSTERA VOLYMEN

Öka (eller minska) volymen på högtalarna genom att vrida volymkontrollen medurs (moturs) på höger högtalare.

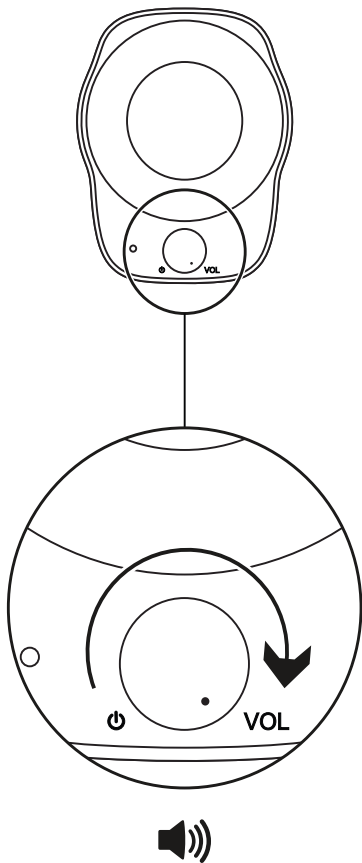

SLADDHANTERING

Om sladden är för lång kan du vira upp den på de praktiska snurrorna bakom högtalarna.

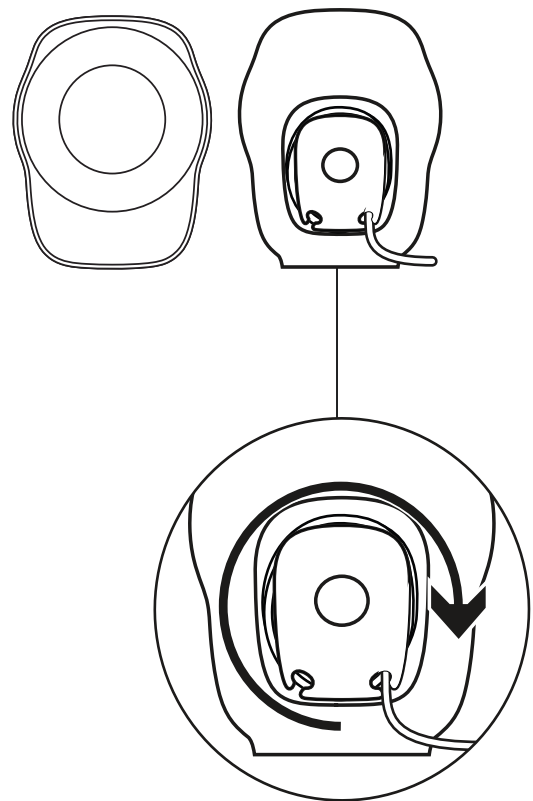

www.logitech.com/support/Z120

OVERSIGT OVER PRODUKTET

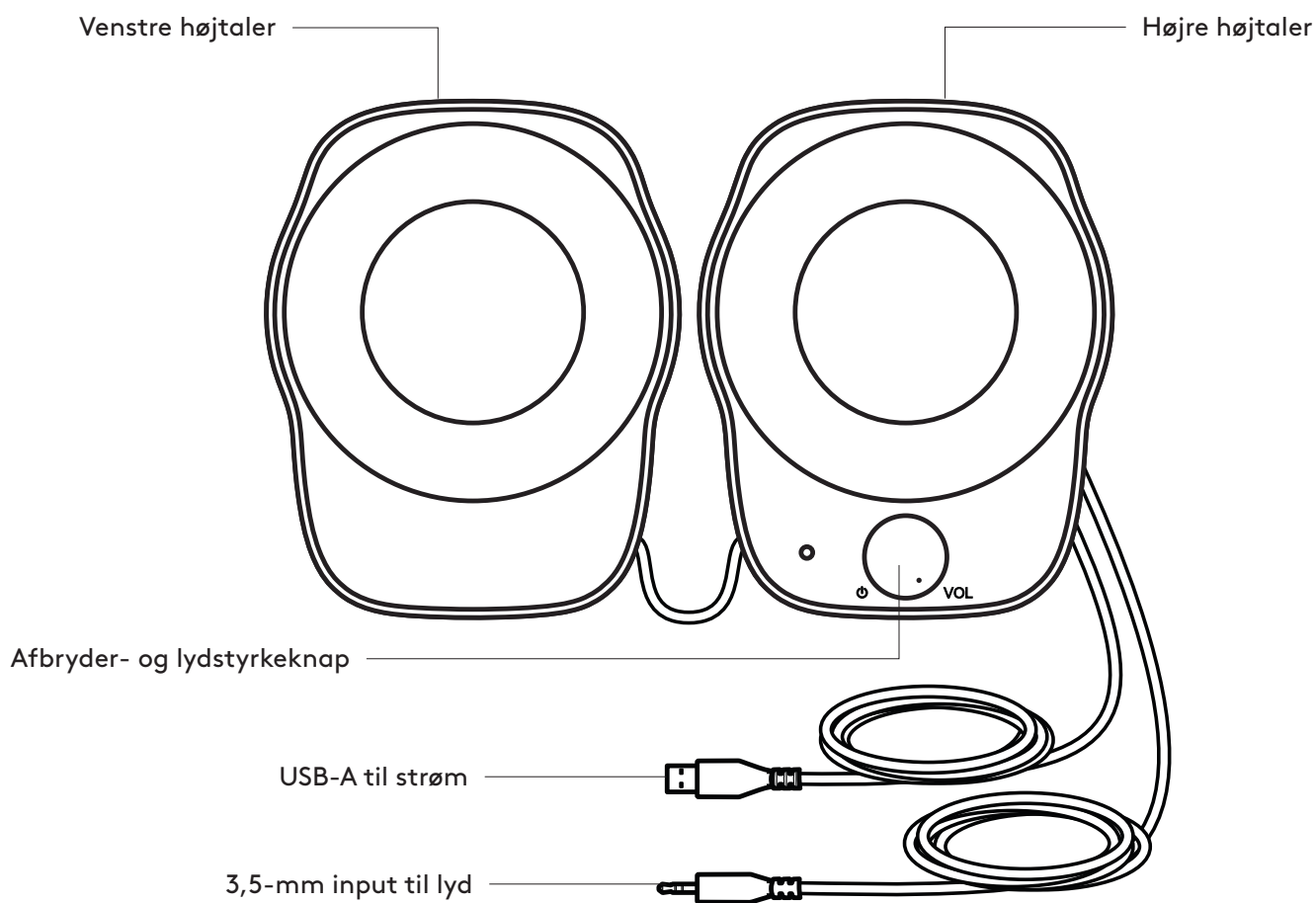
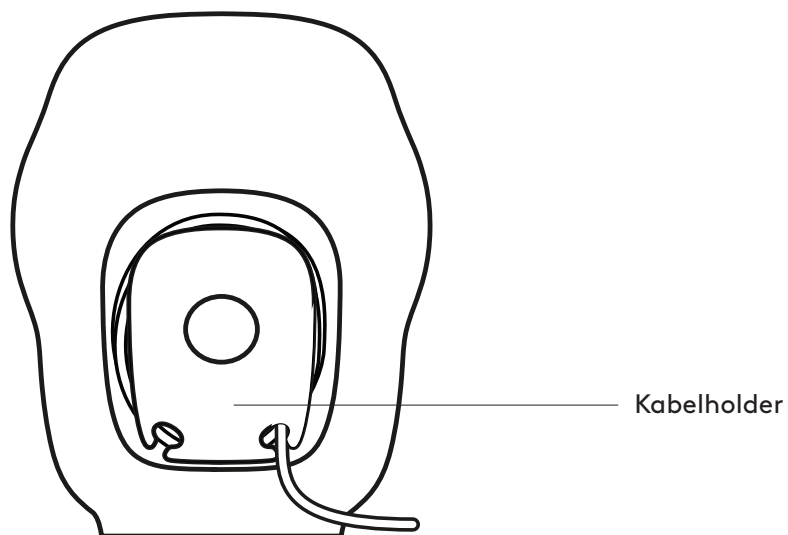

TILSLUTNING AF HØJTALERNE

1. Sæt USB-A-stikket i USB-A-porten på computeren for at forsyne højttalerne med strøm.
2. Sæt 3-5-mm stikket i 3,5-mm udgangen på lydenheden.
3. Tænd for højttaleren vha. afbryderknappen.

1

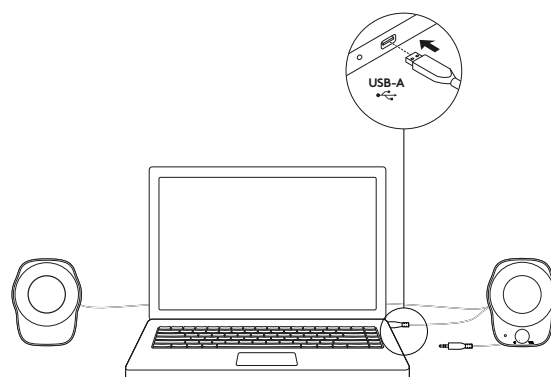

2

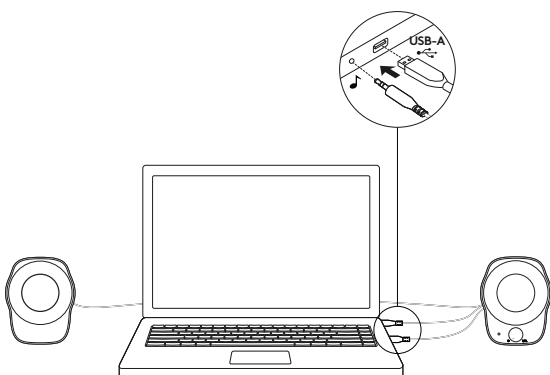

3

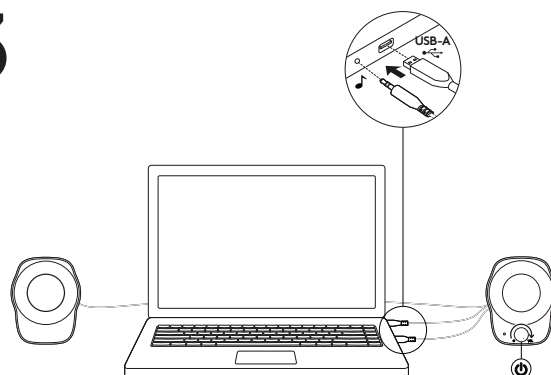

JUSTERING AF LYDSTYRKE

Lydstyrken i højttalerne justeres ved at dreje lydstyrkeknappen på den højre højttaler.

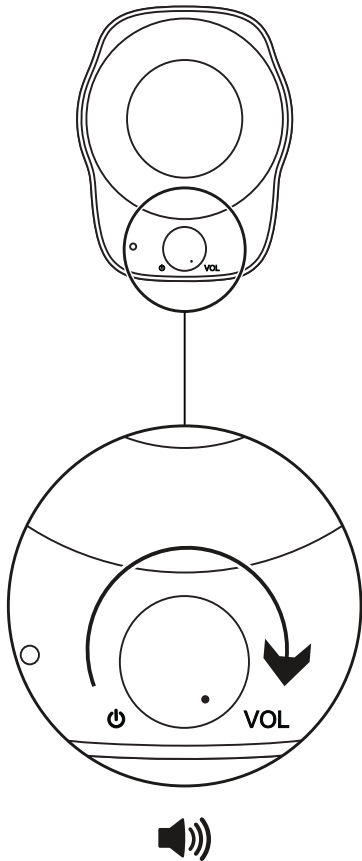

KABELHOLDER

Hvis kablerne er for lange, kan du folde det overskydende stykke sammen bag på højttalerne.

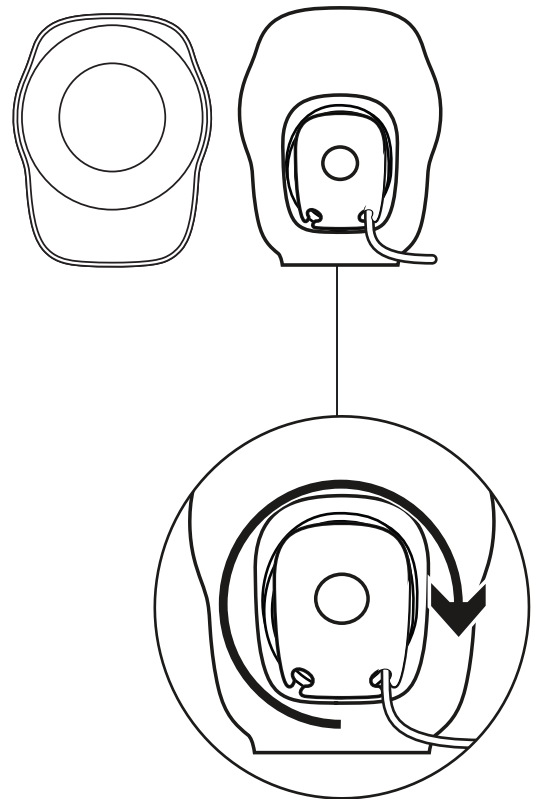

www.logitech.com/support/Z120

BLI KJENT MED PRODUKTET

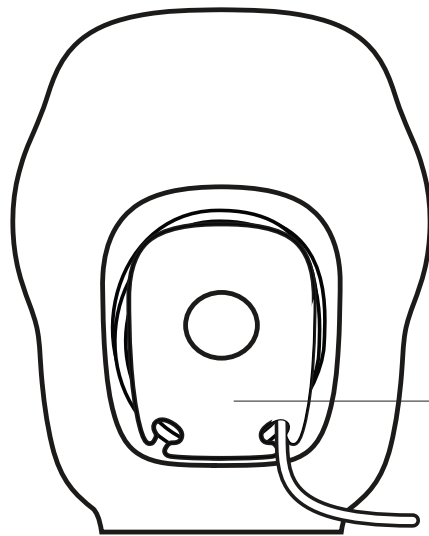

Ledningshåndtering

Venstre høyttaler

Høyre høyttaler

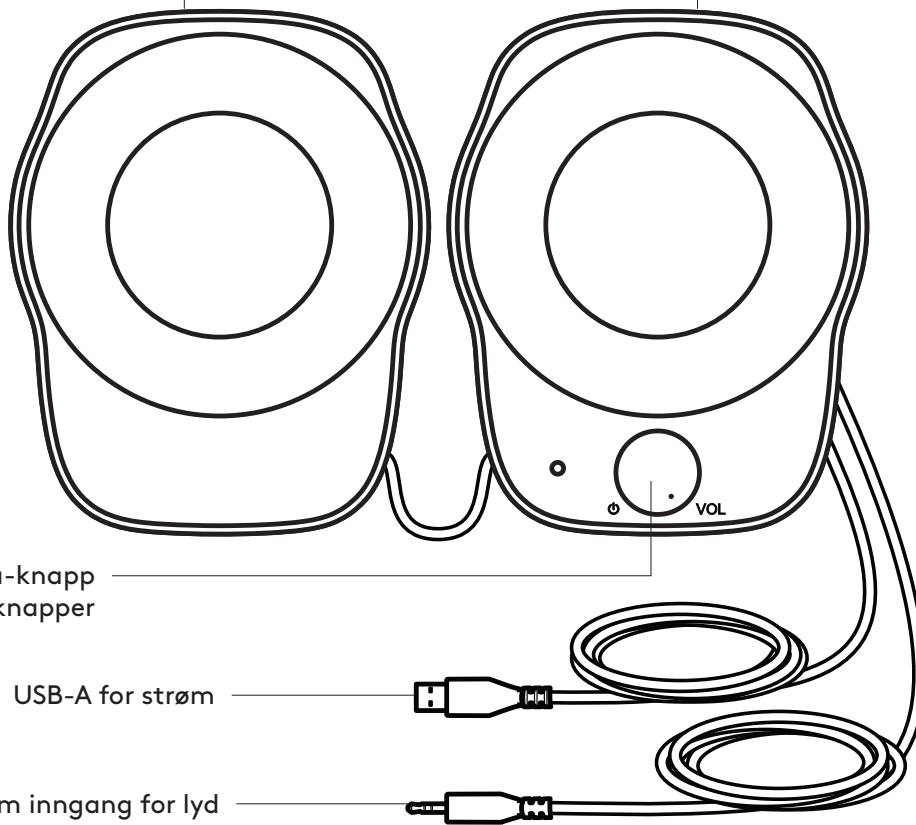

Av/på-knapp
og volumknapper

USB-A for strøm

3,5 mm inngang for lyd

KOBLE TIL HØYTTALERNE

1. Koble USB-A-støpselet til USB-A-porten på datamaskinen for å få strøm.
2. Koble 3,5 mm-kontakten til 3,5 mm-kontakten på lydenheten.
3. Slå på høyttaleren med Av/på-knappen.

1

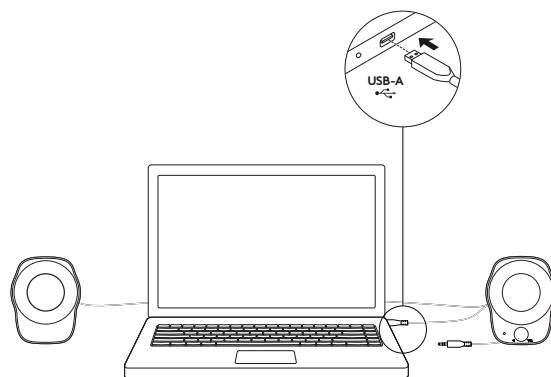

2

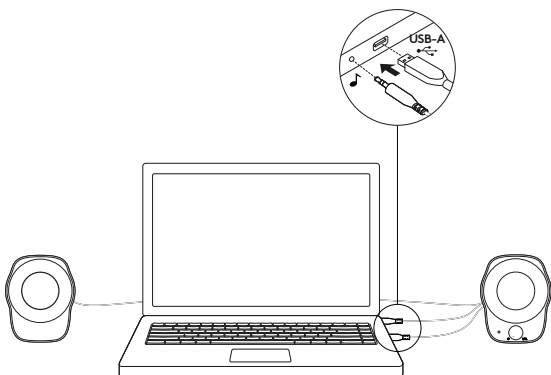

3

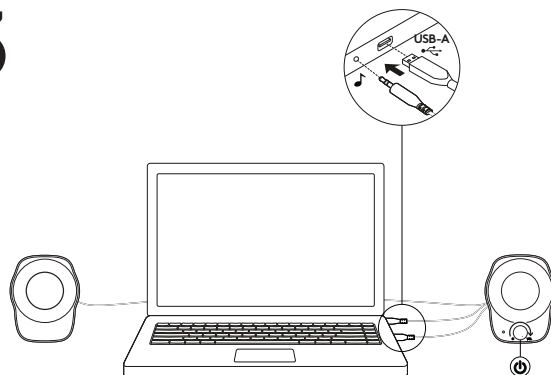

JUSTER VOLUMET

Juster volumet til høyttalerne opp (eller ned) ved å dreie volumknappen med klokken (eller mot klokken) på høyre høyttaler.

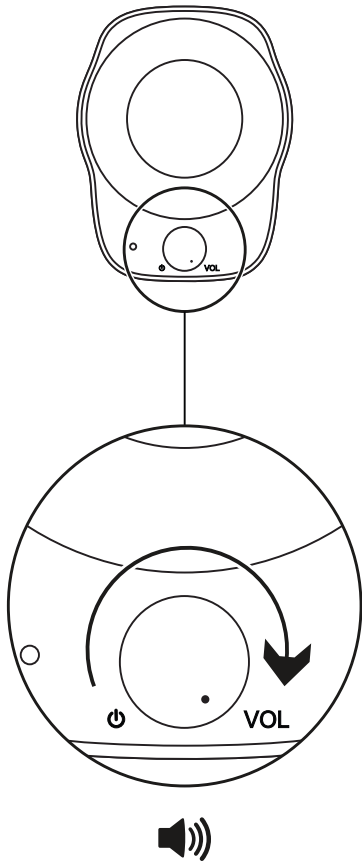

LEDNINGSHÅNTERING

Vikle opp ekstra kabellengde inne i de praktiske rommene bak hver høyttaler.

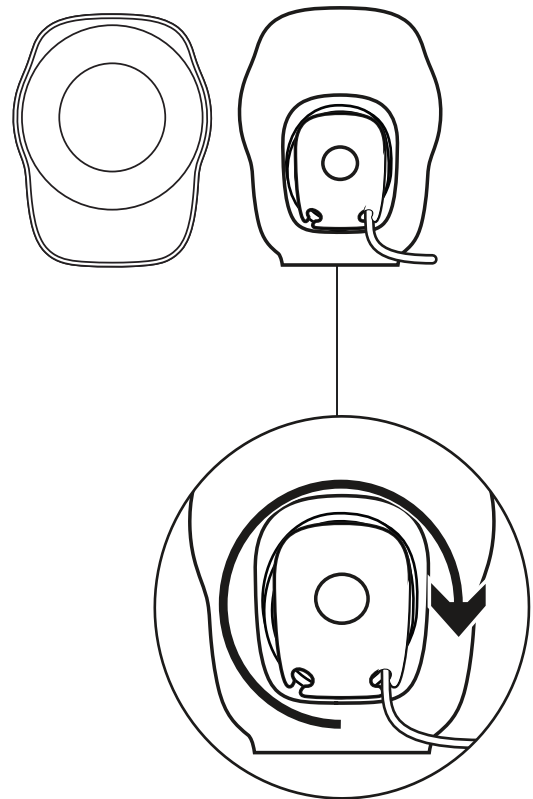

www.logitech.com/support/Z120

TUNNE TUOTTEESI

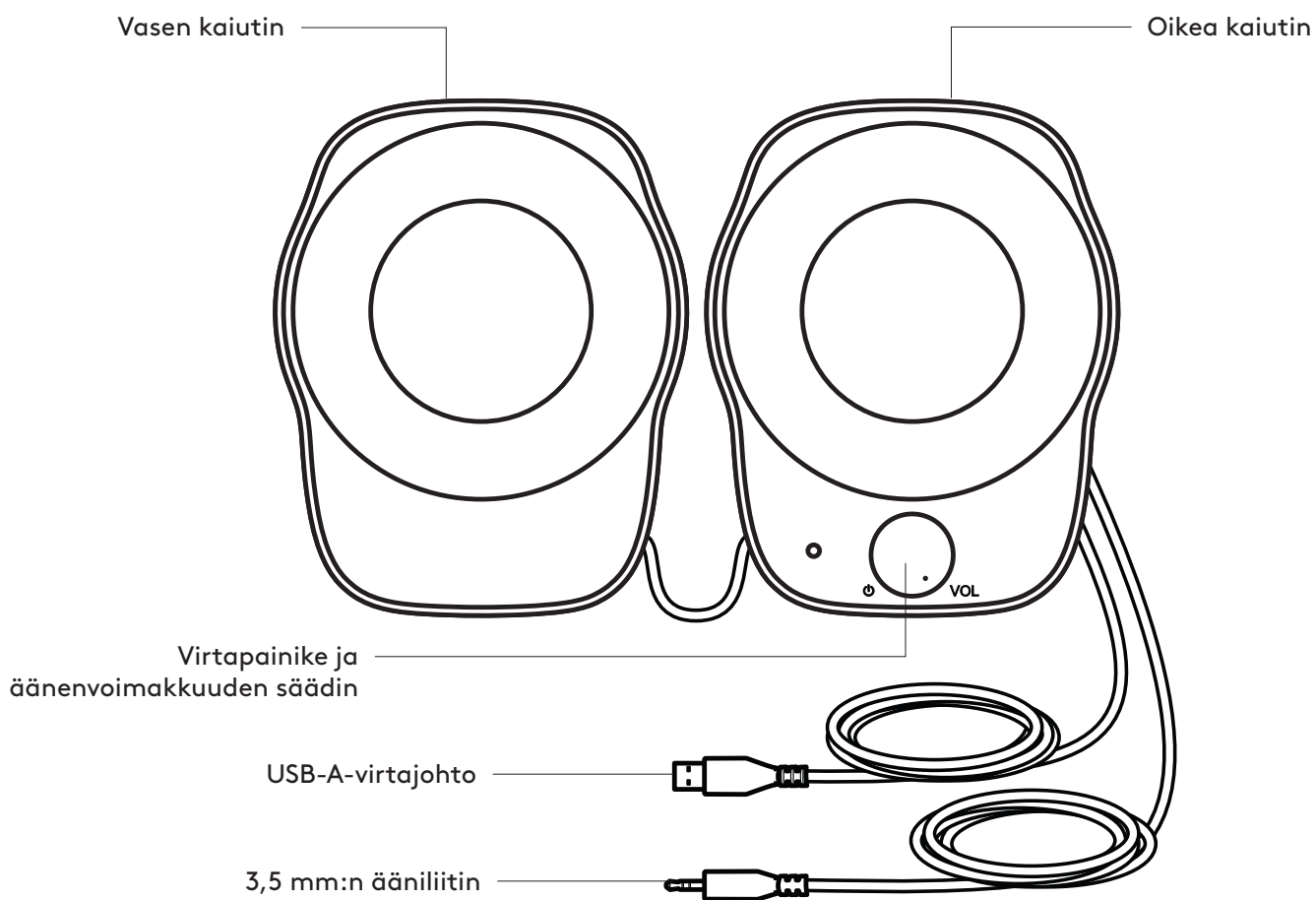
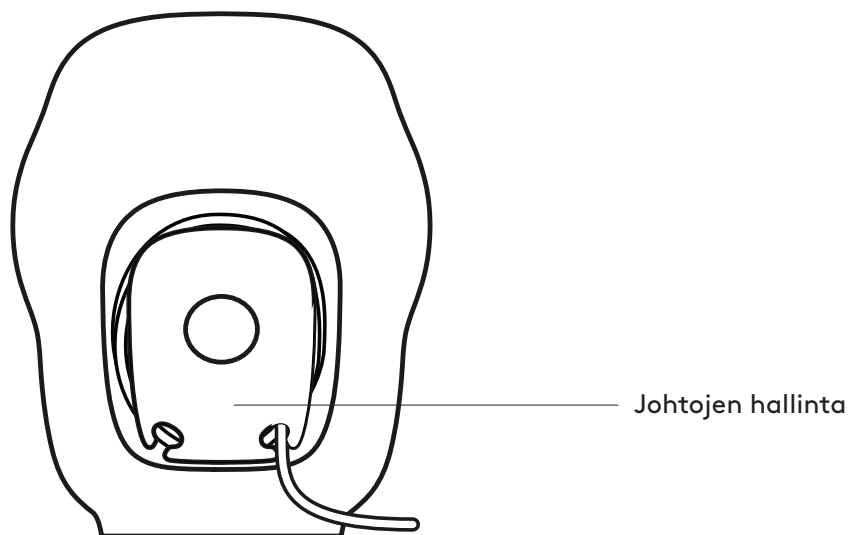

KAIUTTIMIEN YHDISTÄMINEN

1. Yhdistä USB-A-liitin tietokoneen USB-A-porttiin virran kytkemiseksi.
2. Yhdistä 3,5 mm:n liitin äänilaitteen 3,5 mm:n liitännään.
3. Kytke virta kaiuttimeen virtakytkimestä.

1

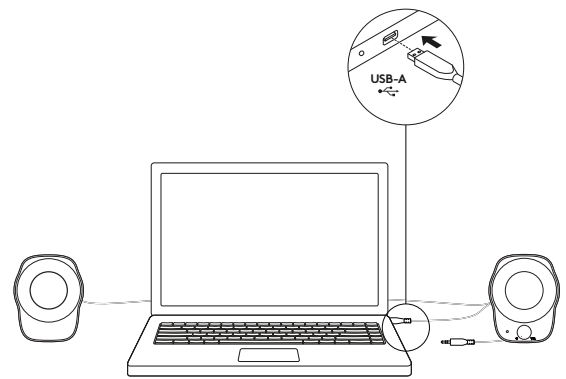

2

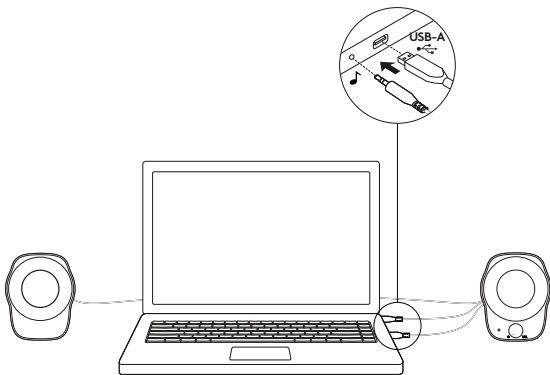

3

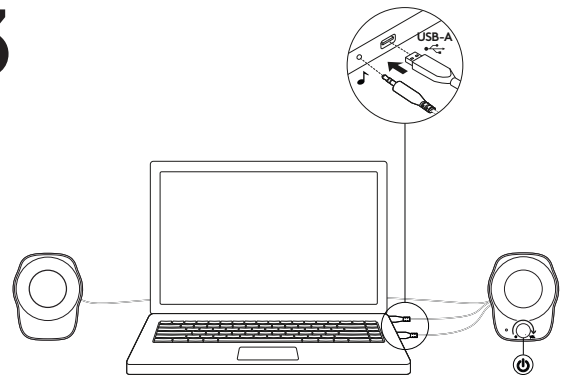

ÄÄNENVOIMAKKUUDEN SÄÄTÄMINEN

Säädä kaiuttimien äänenvoimakkuutta kääntämällä oikean kaiuttimen äänenvoimakkuussäädintä myötäpäivään (lisäys) tai vastapäivään (vähennys).

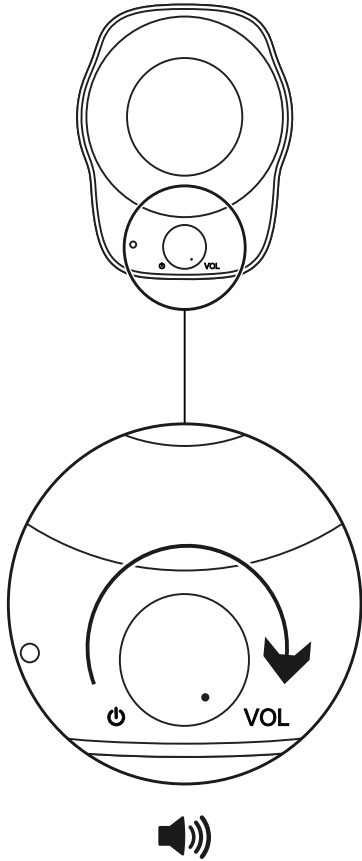

JOHTOJEN HALLINTA

Ylimääräisen johdonmitan voi pyörittää kuulokkeiden taakse.

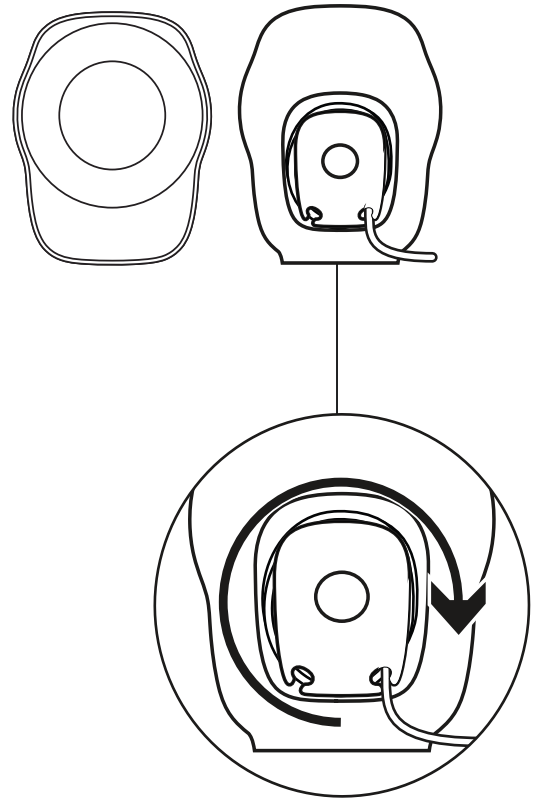

www.logitech.com/support/Z120

ΓΝΩΡΙΣΤΕ ΤΟ ΠΡΟΪΟΝ

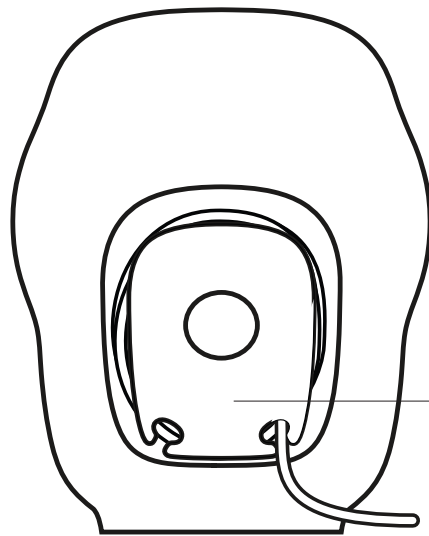

Διαχείριση καλωδίων

Αριστερό ηχείο

Δεξί ηχείο

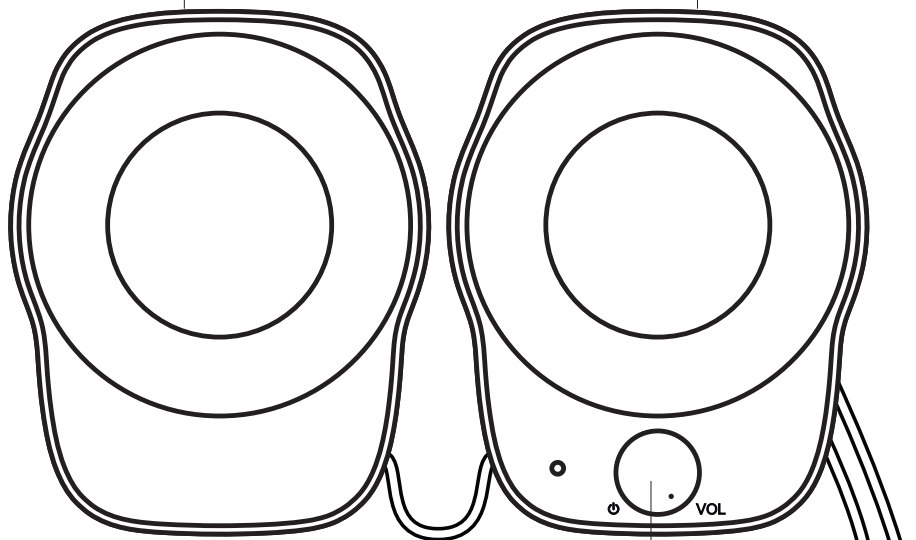

Έλεγχος λειτουργίας και έντασης

Θύρα USB-A για τροφοδοσία



Είσοδος 3,5 mm για ήχο



ΣΥΝΔΕΣΗ ΤΩΝ ΗΧΕΙΩΝ

1. Συνδέστε το βύσμα USB-A στη θύρα USB-A του υπολογιστή σας για τροφοδοσία.
2. Συνδέστε το βύσμα 3,5 mm στην υποδοχή 3,5 mm της συσκευής ήχου.
3. Ενεργοποιήστε το ηχείο χρησιμοποιώντας το στρογγυλό κουμπί ενεργοποίησης.

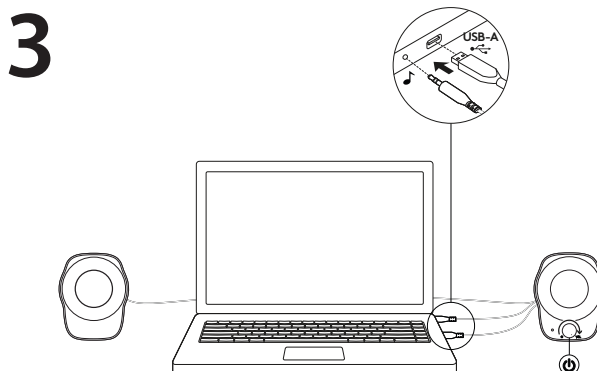
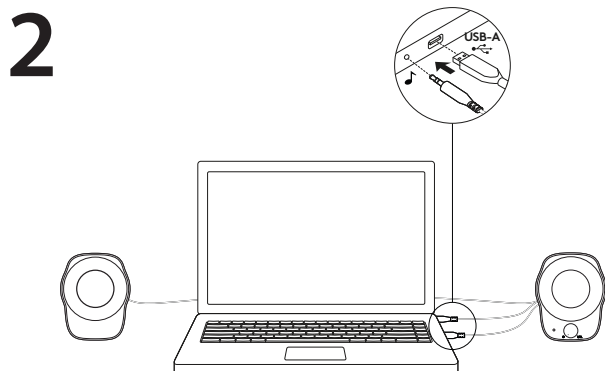
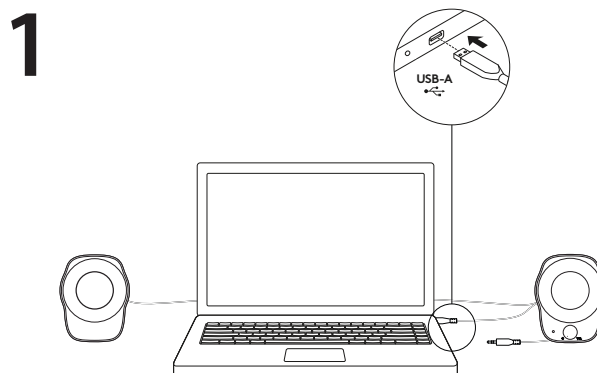

ΡΥΘΜΙΣΗ ΤΗΣ ΕΝΤΑΣΗΣ ΗΧΟΥ

Αυξήστε (ή μειώστε) την ένταση των ηχείων, περιστρέφοντας το κουμπί ελέγχου δεξιόστροφα (αριστερόστροφα) στο δεξί ηχείο.

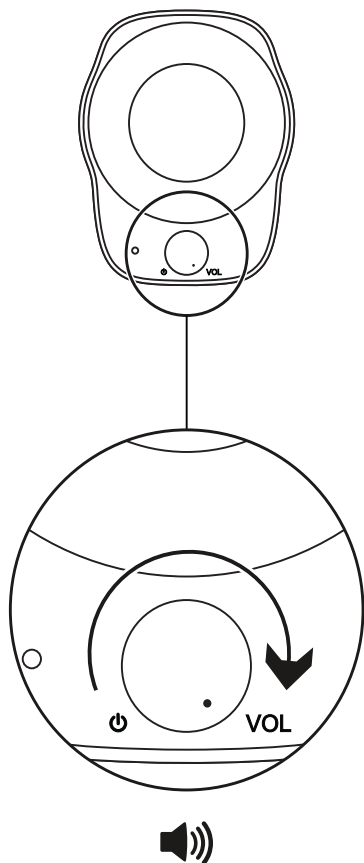

ΔΙΑΧΕΙΡΙΣΗ ΚΑΛΩΔΙΩΝ

Μαζέψτε το επιπλέον μήκος καλωδίου μέσα στους βολικούς χώρους στο πίσω μέρος κάθε ηχείου.

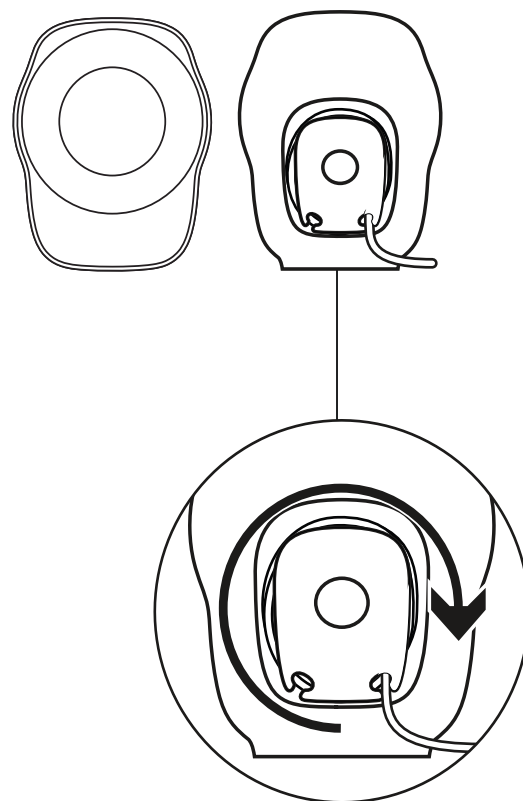

www.logitech.com/support/Z120

ЗНАКОМСТВО С УСТРОЙСТВОМ

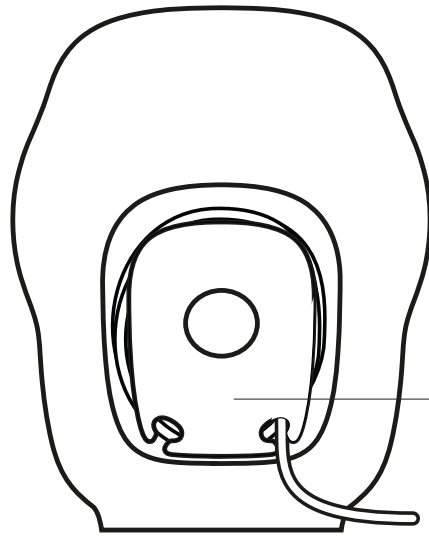

Система регулировки
длины кабеля

Левая колонка

Правая колонка

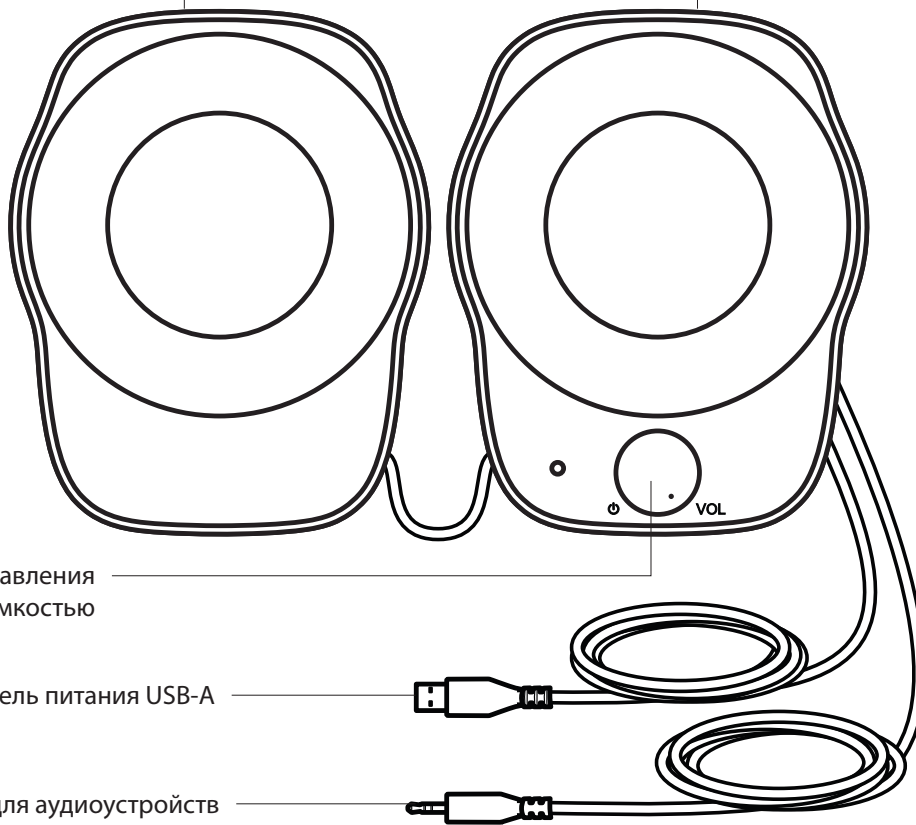

Ручка управления
питанием и громкостью

Кабель питания USB-A

Вход 3,5 мм для аудиоустройств

ПОДКЛЮЧЕНИЕ КОЛОНОК

1. Подключите разъем кабеля питания USB-A к порту USB-A на компьютере.
2. Подсоедините штекер 3,5 мм к разъему 3,5 мм на устройстве — источнике аудиосигнала.
3. Включите колонку, нажав кнопку питания.

1

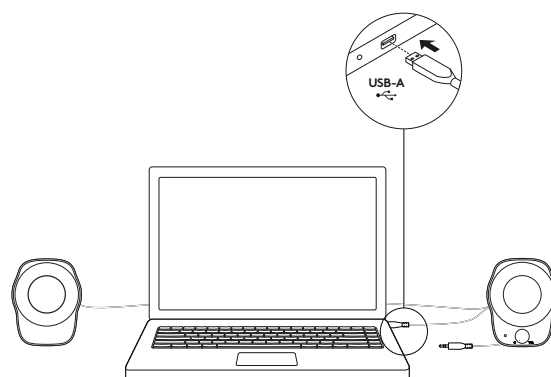

2

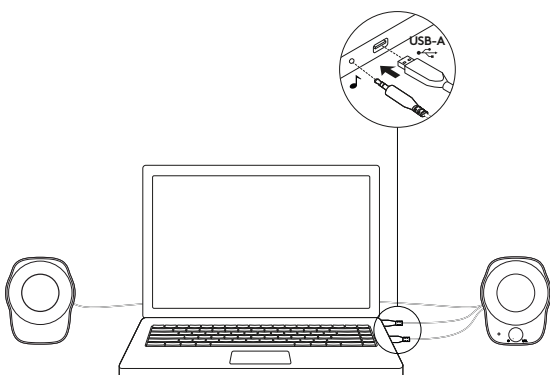

3

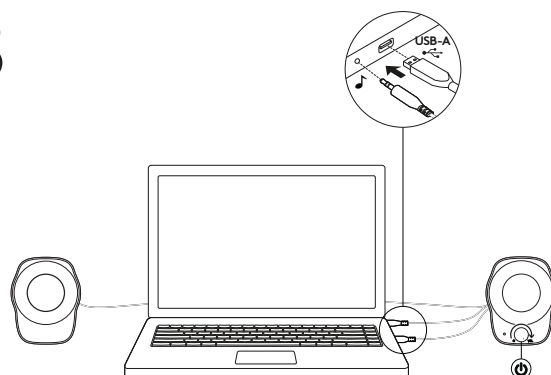

РЕГУЛИРОВКА ГРОМКОСТИ

Чтобы увеличить (уменьшить) громкость воспроизведения, поверните регулятор громкости на правой колонке по часовой стрелке либо против часовой стрелки.

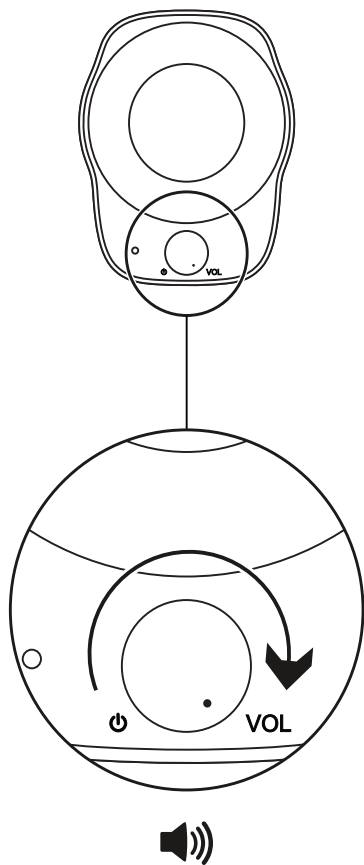

СИСТЕМА РЕГУЛИРОВКИ ДЛИНЫ КАБЕЛЯ

Если кабель слишком длинный, сматывайте его до нужной длины и расположите петли в специальных местах на задней панели каждой колонки.

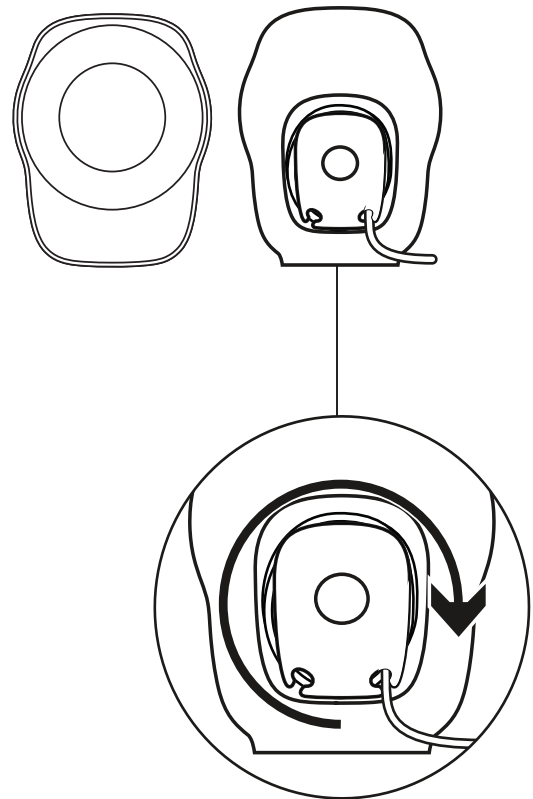

www.logitech.com/support/Z120

OPIS URZĄDZENIA

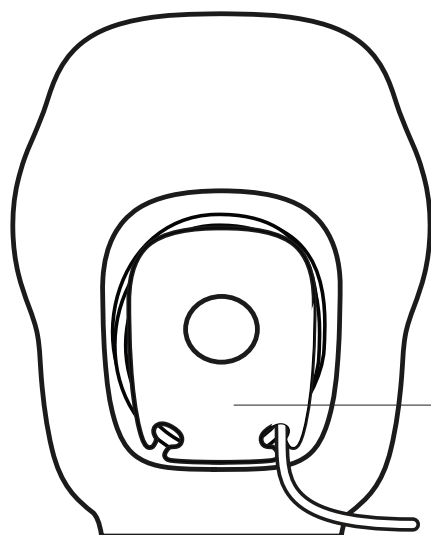

Regulacja długości kabla

Głośnik lewy

Prawy głośnik

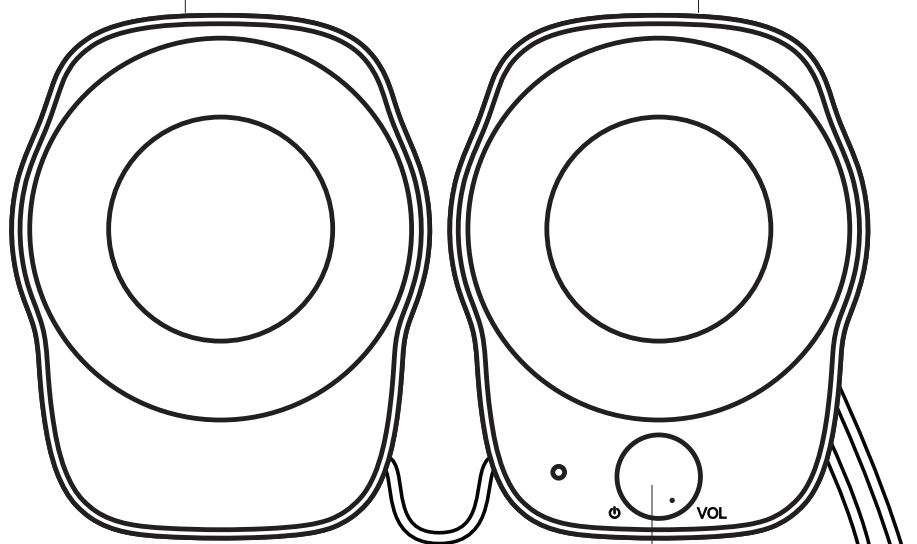

Elementy sterowania zasilaniem i głośnością

Zasilanie przez port USB-A



Wejście audio 3,5 mm

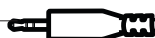

PODŁĄCZANIE GŁOŚNIKÓW

1. Podłącz wtyczkę USB-A do portu USB-A w komputerze, aby uzyskać zasilanie.
2. Podłącz złącze 3,5 mm do gniazda jack 3,5 mm w urządzeniu audio.
3. Włącz głośniki za pomocą pokrętła zasilania.

1

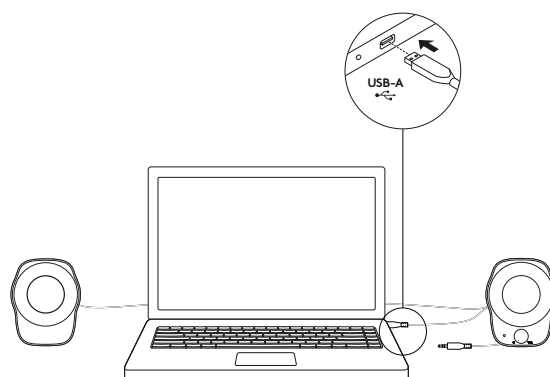

2

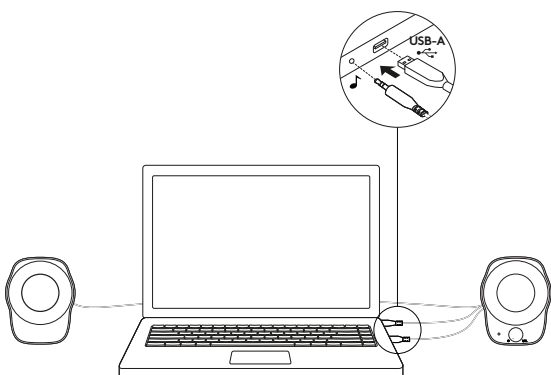

3

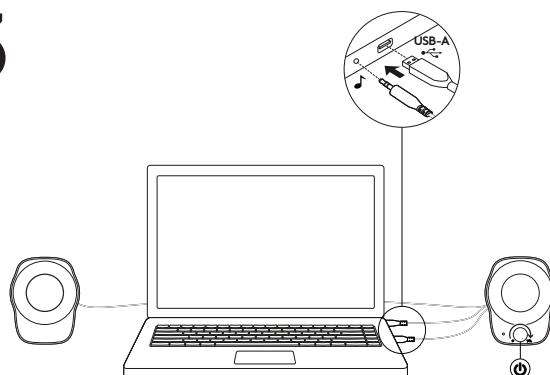

REGULACJA GŁOŚNOŚCI

Zwiększ (lub zmniejsz) poziom głośności głośników, obracając pokrętkę regulacji głośności w kierunku zgodnym z ruchem wskazówek zegara (lub przeciwnym) na prawym głośniku.

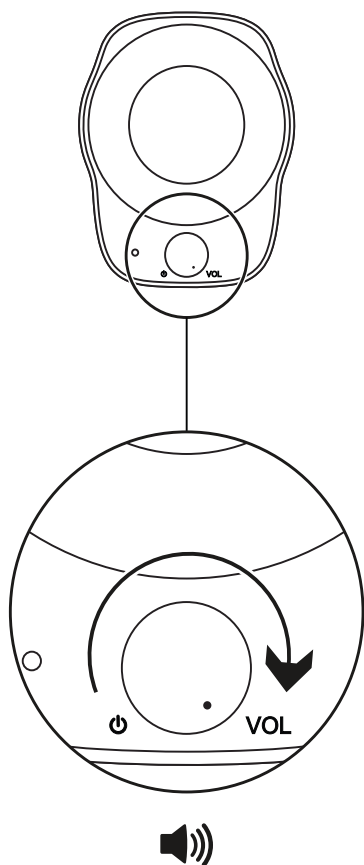

REGULACJA DŁUGOŚCI KABLA

Schowaj niepotrzebną część kabla w wygodnych otworach z tyłu głośników.

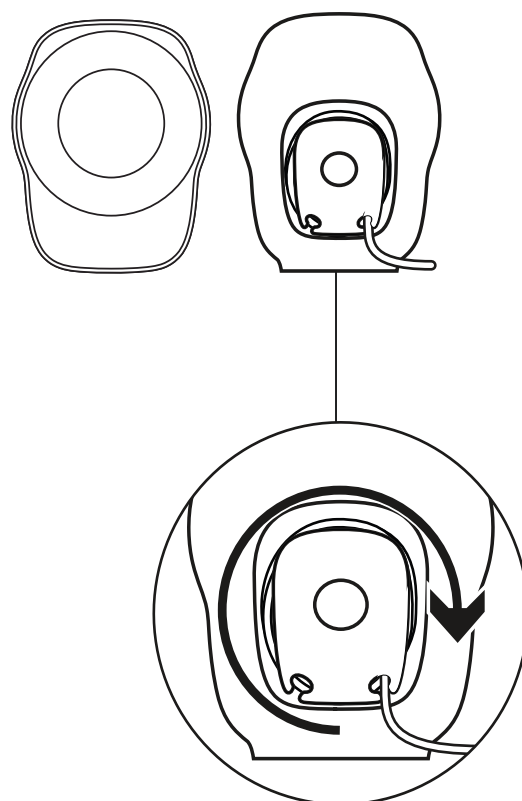

www.logitech.com/support/Z120

A TERMÉK ISMERTETÉSE

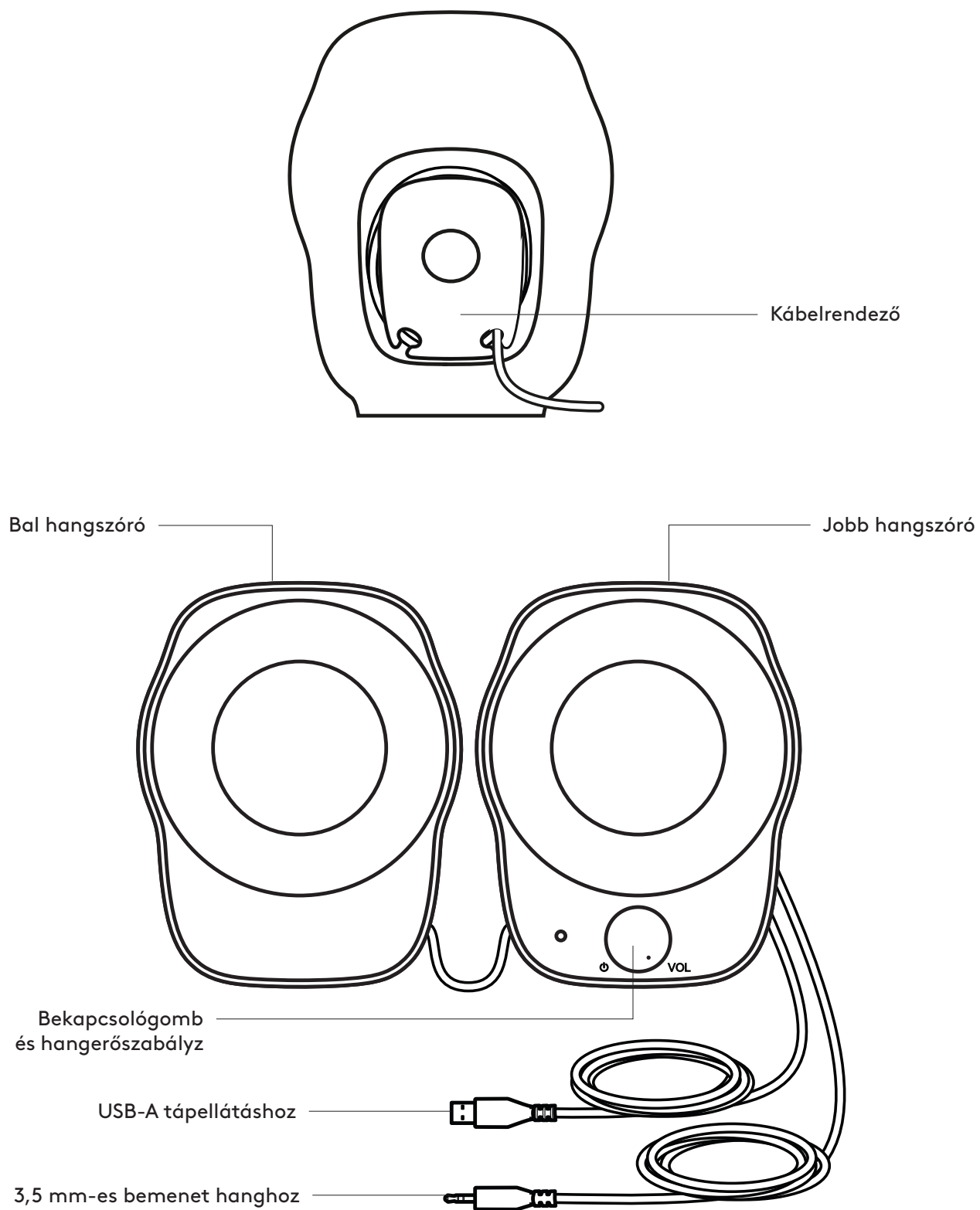

A HANGSZÓRÓK CSATLAKOZTATÁSA

1. A tápellátáshoz dugja az USB-A-csatlakozót a számítógép USB-A portjába.
2. Dugja be a 3,5 mm csatlakozót a 3,5 mm-es bemenetbe a hangszközén.
3. Kapcsolja be a hangszórót a bekapcsológombbal.

1

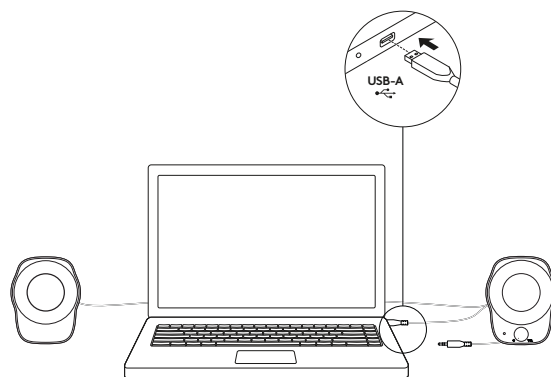

2

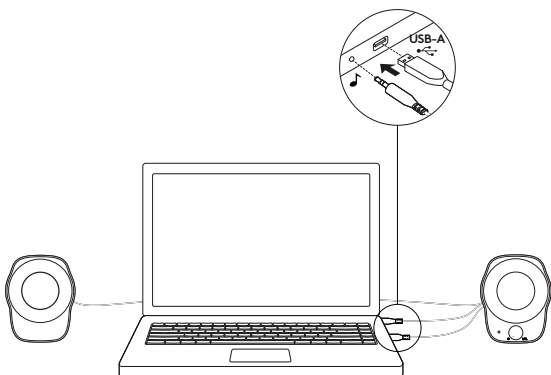

3

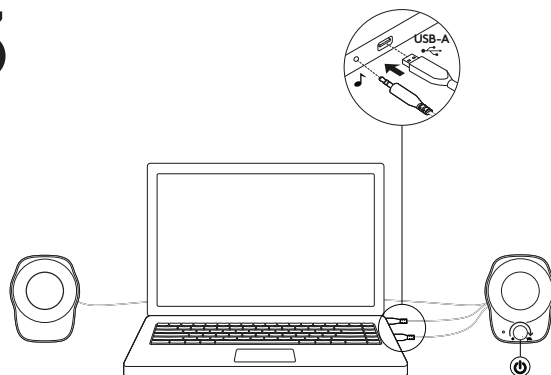

A HANGERŐ SZABÁLYOZÁSA

A hangerő a jobb oldali hangszóró hangerőszabályzó gombjának jobbra (vagy balra) forgatásával növelhető (vagy csökkenthető).

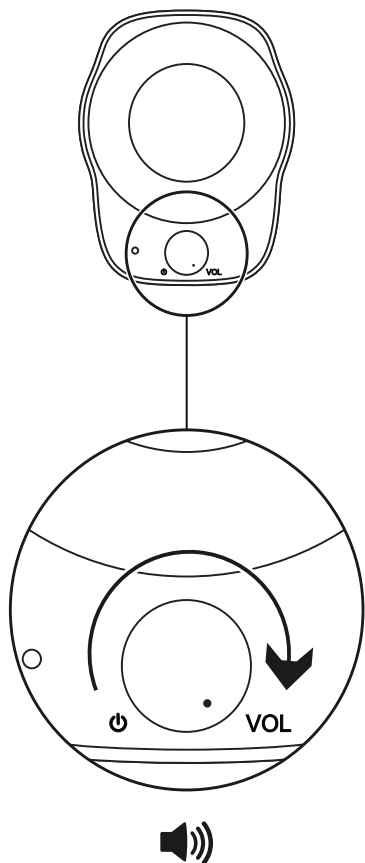

KÁBELRENDEZŐ

A felesleges kábelhosszat a hangszórók mögött lévő tágas tartóba tekerheti fel.

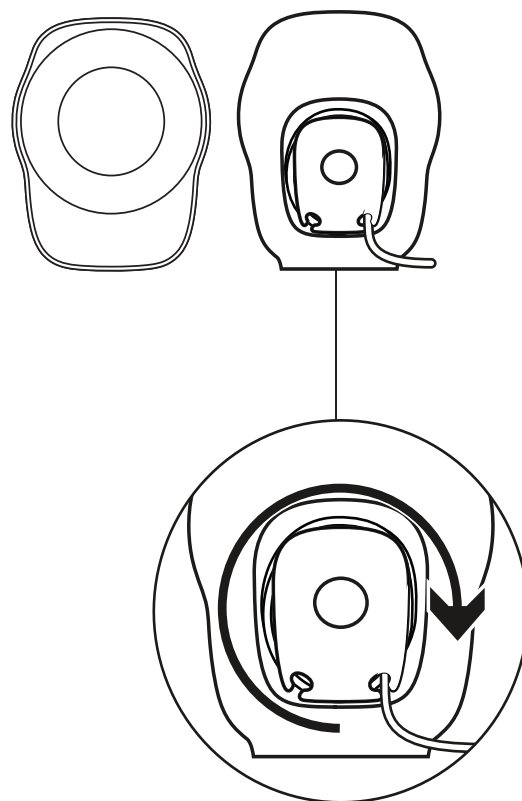

www.logitech.com/support/Z120

POPIS PRODUKTU

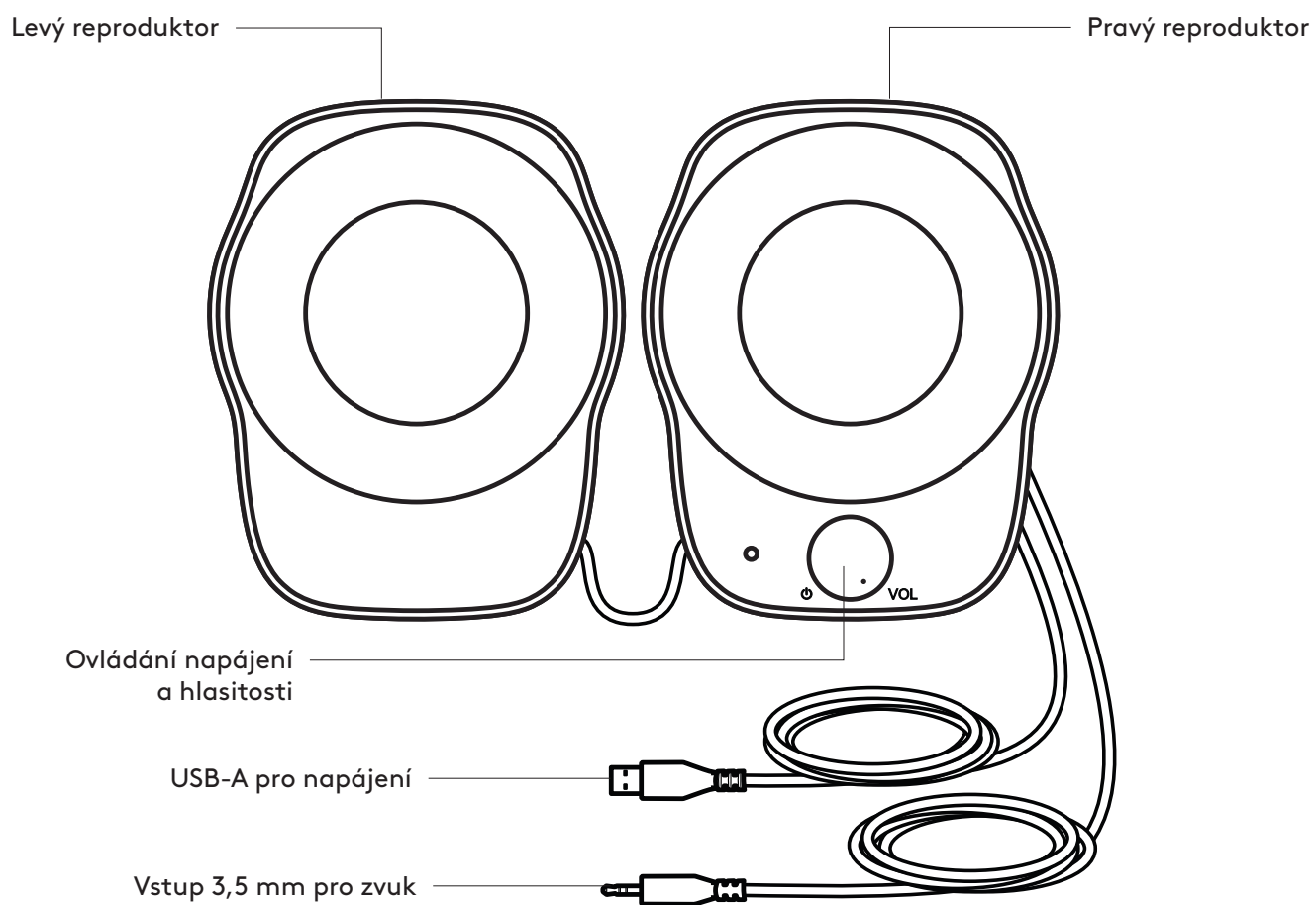
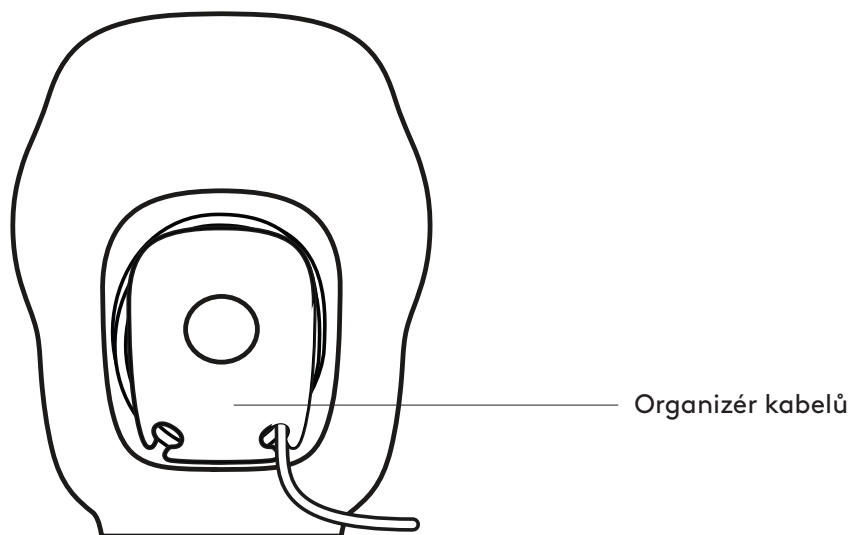

PŘIPOJENÍ REPRODUKTORŮ

1. Zapojte konektor USB-A do portu USB-A na vašem počítači za účelem napájení.
2. Zapojte konektor 3,5 mm do zdířky 3,5 mm na vašem audio zařízení.
3. Zapněte reproduktory pomocí ovládání napájení.

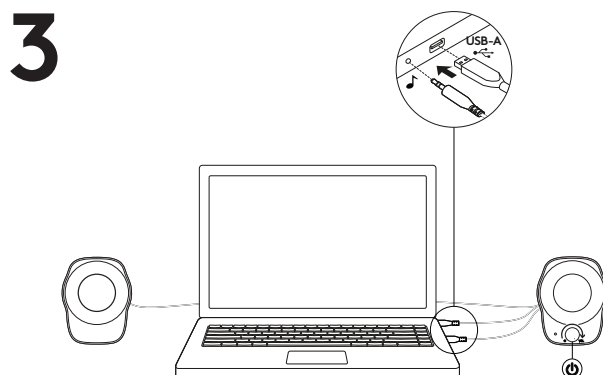
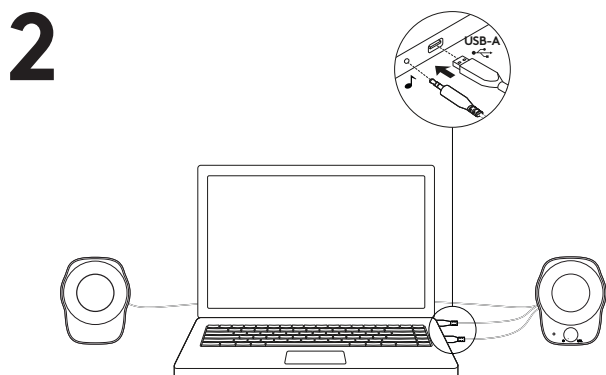
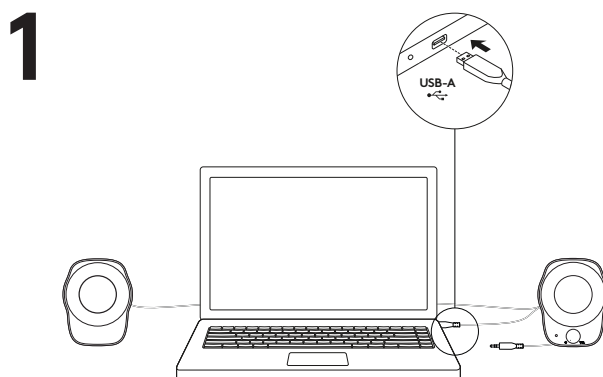

NASTAVENÍ HLASITOSTI

Hlasitost reproduktorů zvýšíte (nebo snížíte) otáčením ovládacího knoflíku hlasitosti na pravém reproduktoru ve směru (nebo proti směru) hodinových ručiček.

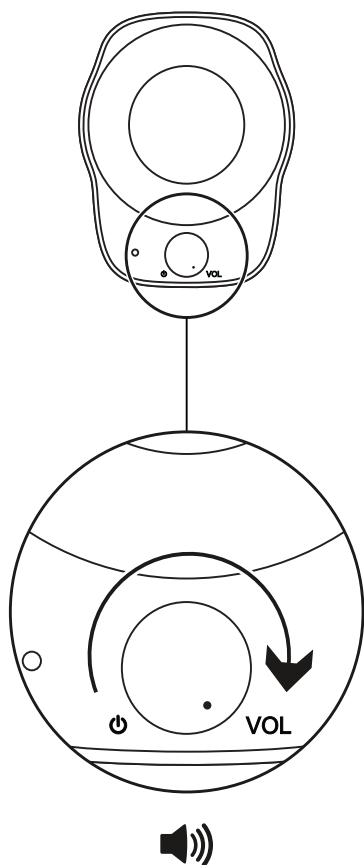

ORGANIZÉR KABELŮ

Přebytečnou kabeláž naviňte do úložného prostoru v zadní části reproduktorů.

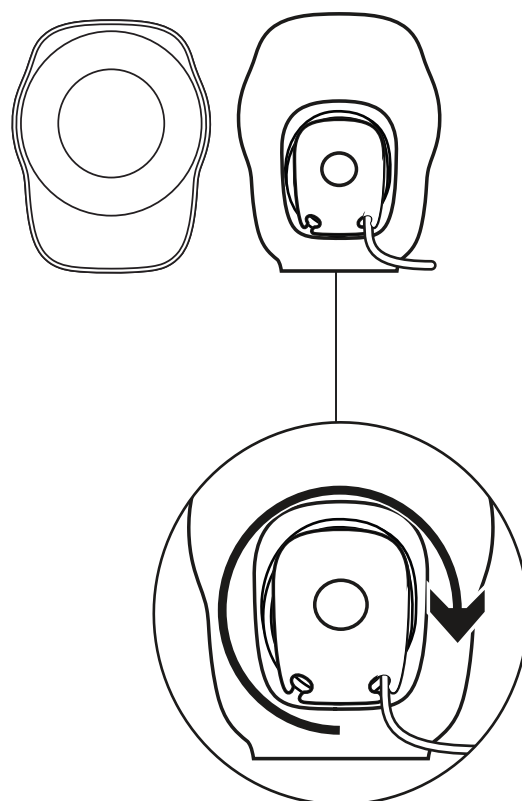

www.logitech.com/support/Z120

POPIS PRODUKTU

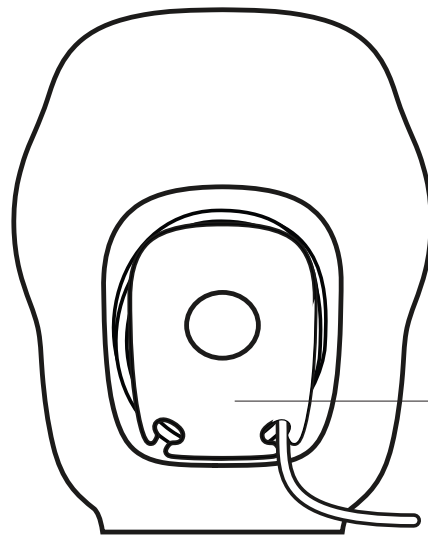

System na
usporiadanie káblov

Ľavý reproduktor

Pravý reproduktor

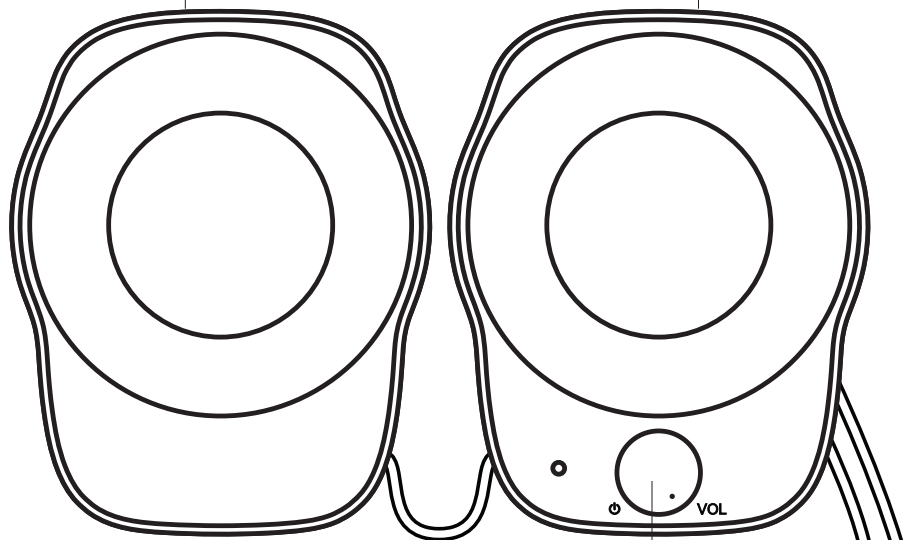

Ovládanie napájania
a hlasitosti

USB-A pre napájanie

Vstup 3,5 mm pre zvuk



PRIPOJENIE REPRODUKTOROV

1. Zapojte konektor USB-A do portu USB-A na vašom počítači s cieľom napájania.
2. Zapojte konektor 3,5 mm do prípojky 3,5 mm na vašom audio zariadení.
3. Zapnite reproduktory pomocou tlačidla napájania.

1

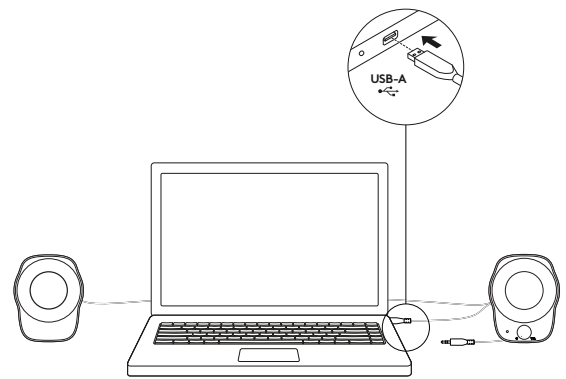

2

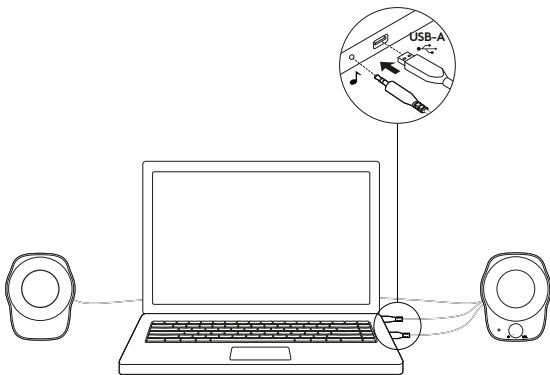

3

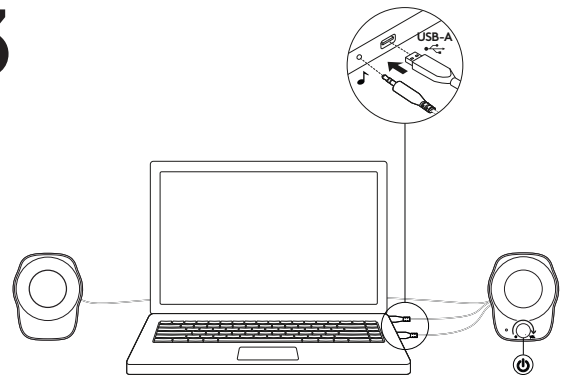

NASTAVENIE HLASITOSTI

Hlasitosť reproduktorov zvýšite (alebo znížite) otáčaním ovládacieho gombíka hlasitosti na pravom reproduktore v smere (alebo proti smeru) hodinových ručičiek.

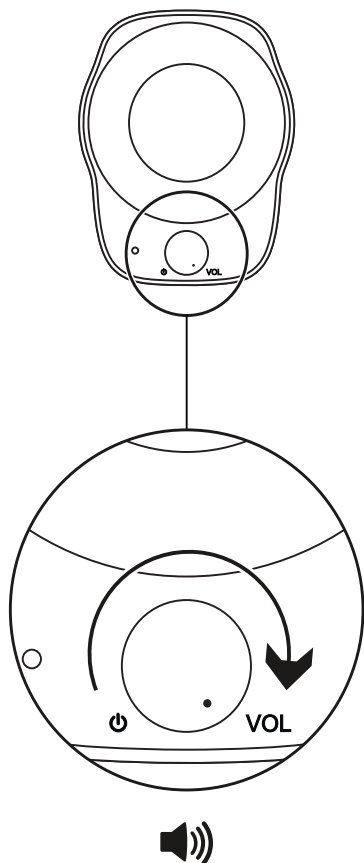

SYSTÉM NA USPORIADANIE KÁBLOV

Prebytočnú kabeláž naviňte do úložného priestoru v zadnej časti reproduktorov.

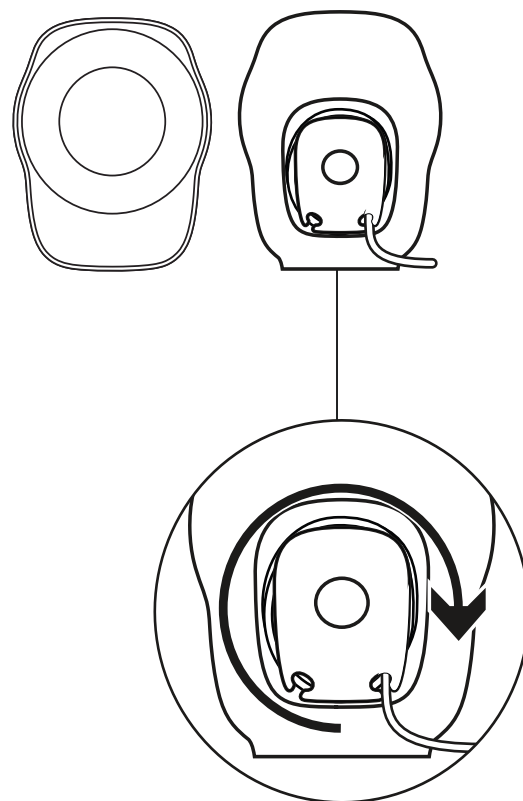

www.logitech.com/support/Z120

ОЗНАЙОМЛЕННЯ З ПРИСТРОЄМ

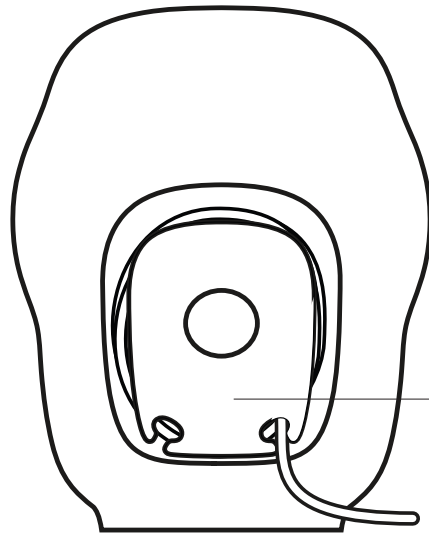

Система регулювання довжини кабелю

Ліва колонка

Права колонка

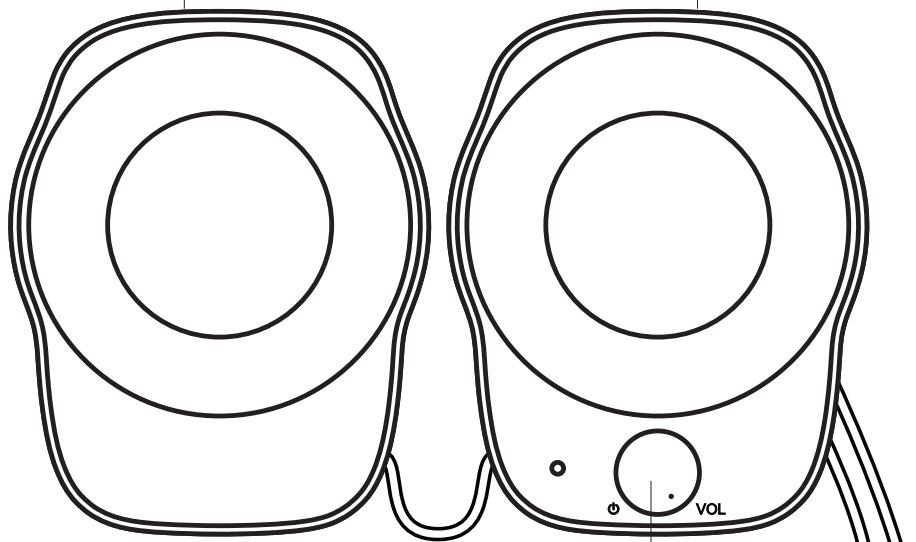

Ручка керування живленням і гучністю

Кабель живлення USB-A



Роз'єм 3,5 мм (для аудіопристроїв)



ПІДКЛЮЧЕННЯ ДИНАМІКІВ

1. Вставте роз'єм USB-A кабелю живлення в порт USB-A комп'ютера.
2. Вставте штекер 3,5 мм у роз'єм 3,5 мм на пристрої, що відтворює аудіосигнали.
3. Увімкніть колонку, натиснувши кнопку живлення.

1

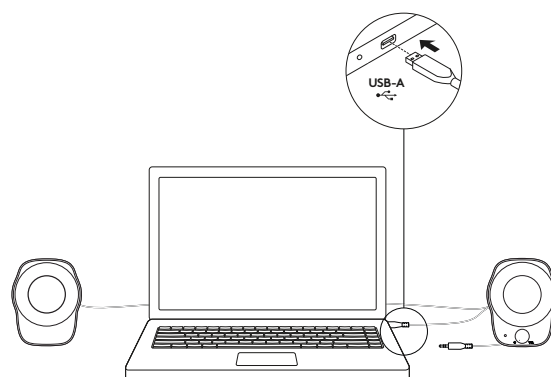

2

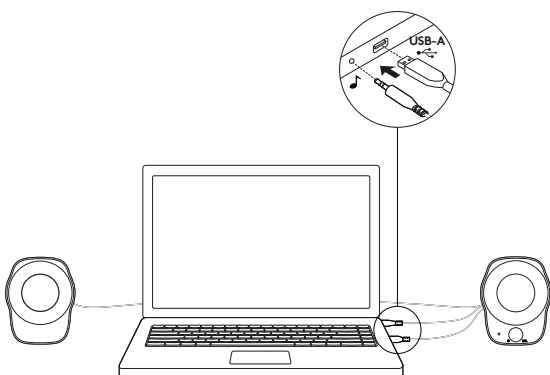

3

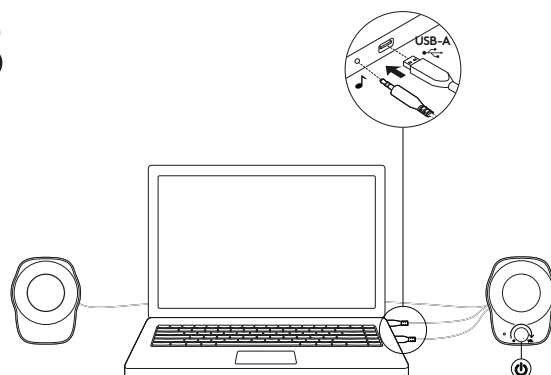

РЕГУЛЮВАННЯ ГУЧНОСТІ

Щоб збільшити (зменшити) гучність відтворення, поверніть регулятор гучності на правому динаміку за годинниковою стрілкою чи проти годинникової стрілки.

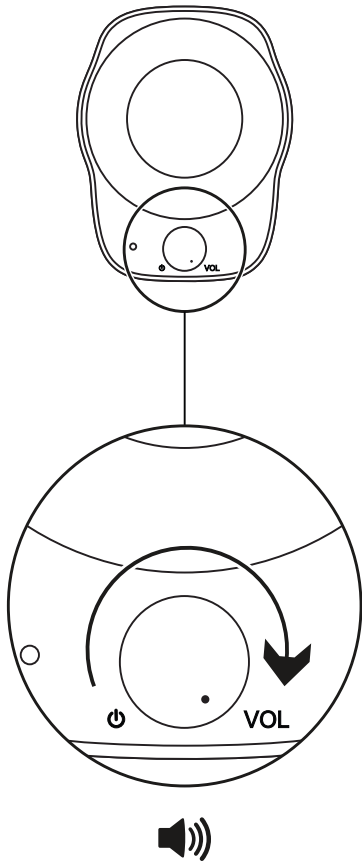

СИСТЕМА РЕГУЛЮВАННЯ ДОВЖИНИ КАБЕЛЮ

Якщо кабель задовгий, змотайте його до потрібної довжини й розмістіть петлі у спеціальних місцях на задній панелі кожного динаміка.

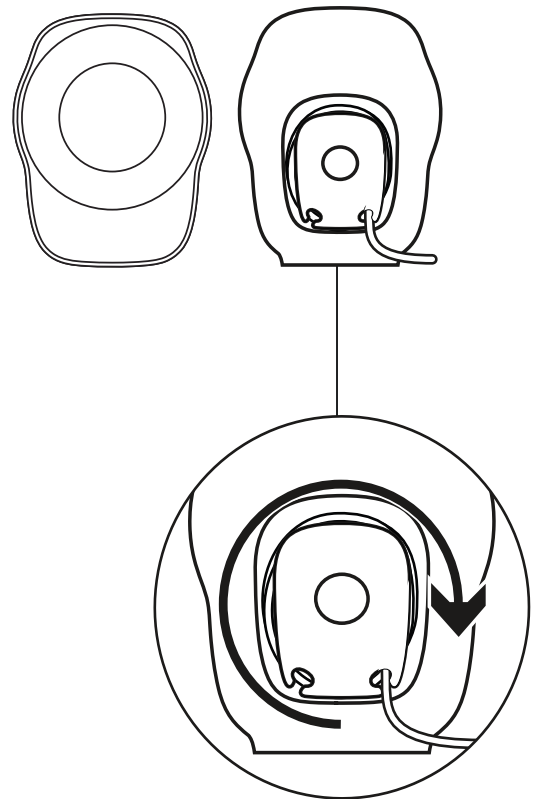

www.logitech.com/support/Z120

TOOTE TUTVUSTUS

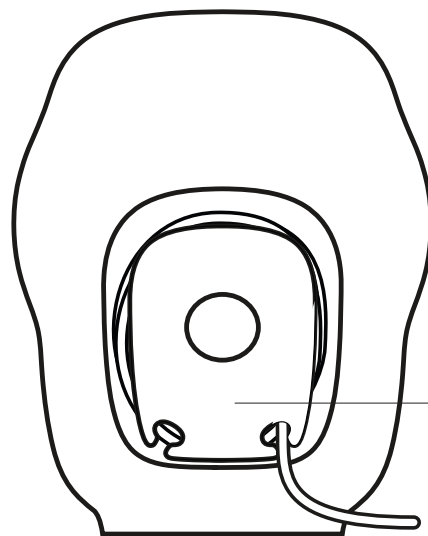

Kaablihdus

Vasakpoolne kõlar

Parempoolne kõlar

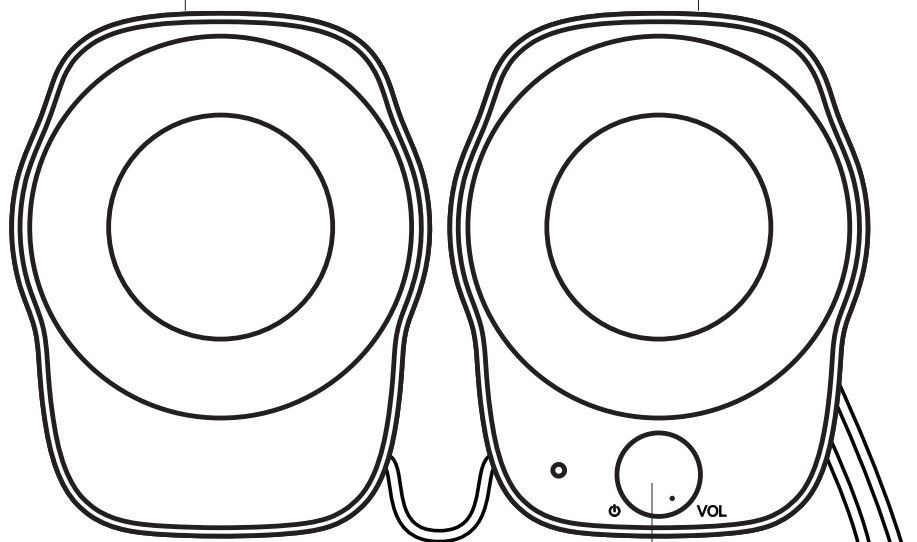

Toite- ja helitugevusnupp

USB-A-toitekaabel



3,5 mm helisisend



KÕLARITE ÜHENDAMINE

1. Pistke USB-A-pistik toite jaoks arvuti USB-A-porti.
2. Pistke 3,5 mm pistik heliseadme 3,5 mm pesa.
3. Lülitage kõlar toitenuppu keerates sisse.

1

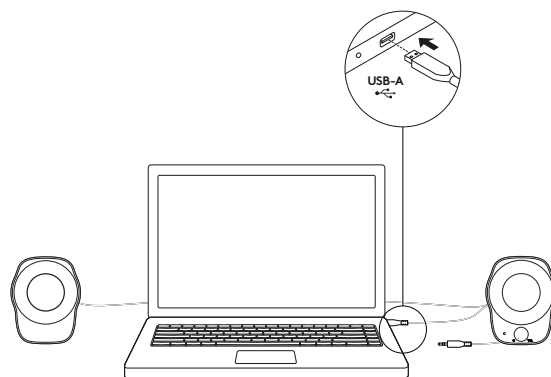

2

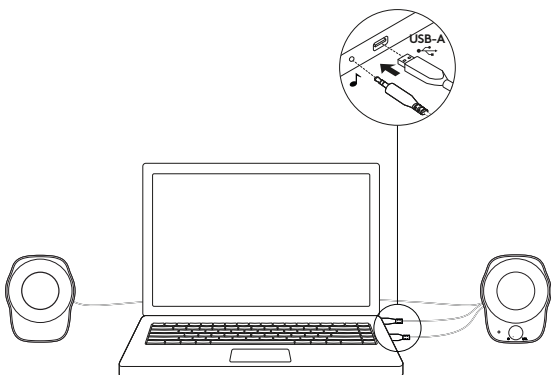

3

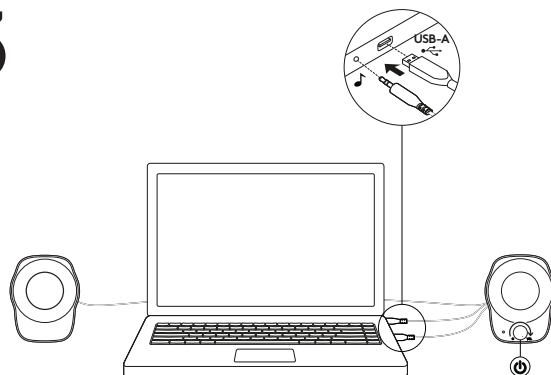

HELITUGEVUSE REGULEERIMINE

Kõlarite helitugevuse suurendamiseks (või vähendamiseks) pöörake parempoolse kõlari peal asuvat helitugevuse reguleerimise nuppu päripäeva (või vastupäeva).

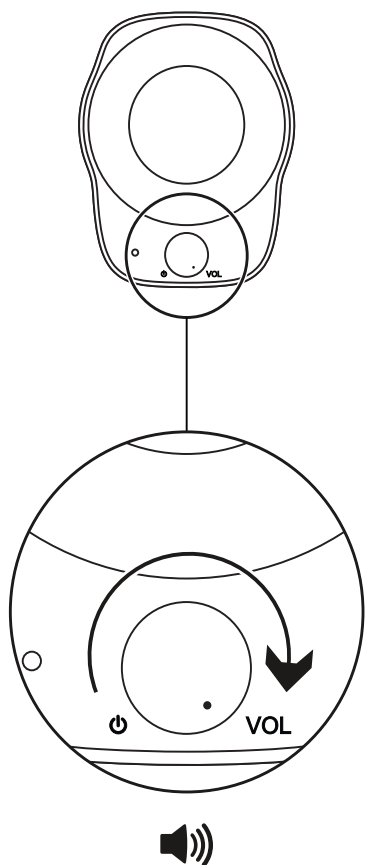

KAABLIHALDUS

Üleliigse kaabli saab kerida kõlarite taga asuvasse käepärastesse kanalitesse.

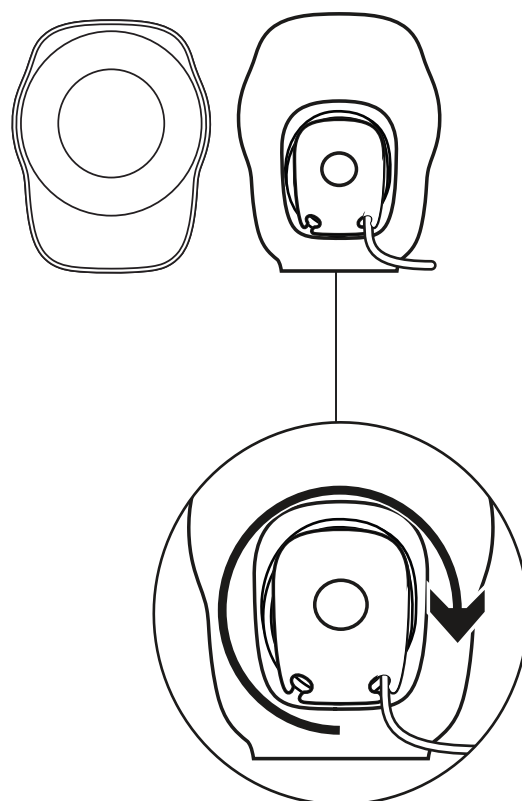

www.logitech.com/support/Z120

PĀRZINIET SAVU IERĪCI

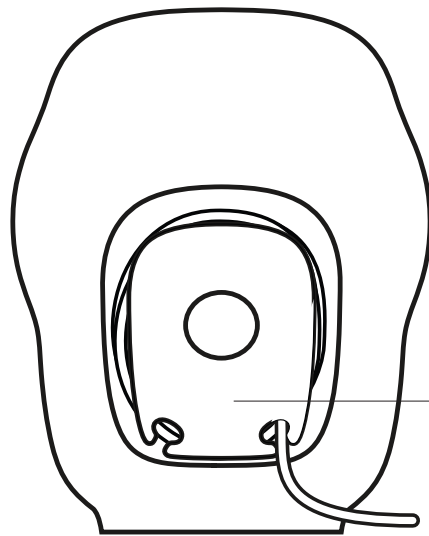

Kabeļa garuma regulēšana

Kreisais skaļrunis

Labais skaļrunis

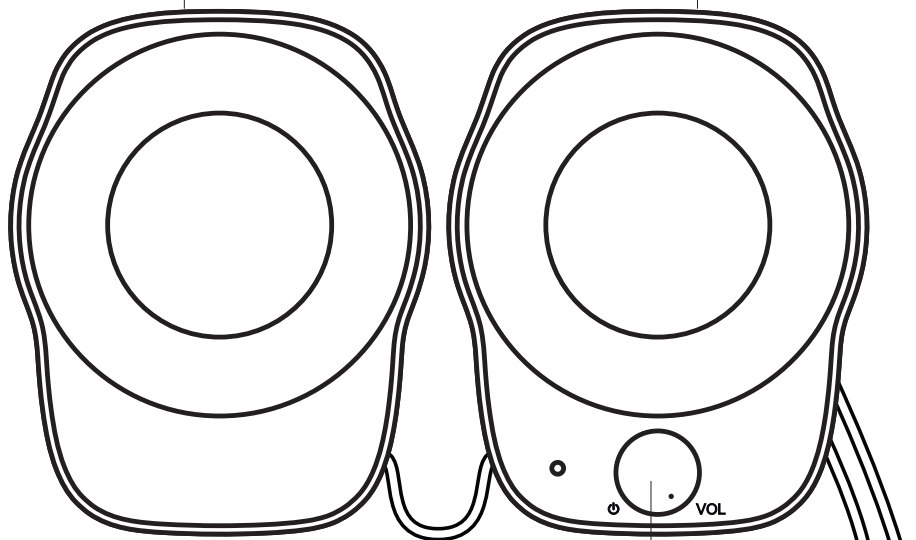

Ieslēgšana un skaļuma vadība

USB-A barošanas vads



3,5 mm spraudnis skaņai



SKAĻRUŅU PIEVIENOŠANA

1. Lai nodrošinātu barošanu, iespraudiet A tipa USB kabeli datora A tipa USB pieslēgumā.
2. Iespraudiet 3,5 mm spraudni audioierīces 3,5 mm ligzdā.
3. Ieslēdziet skaļruņus, izmantojot barošanas pogu.

1.

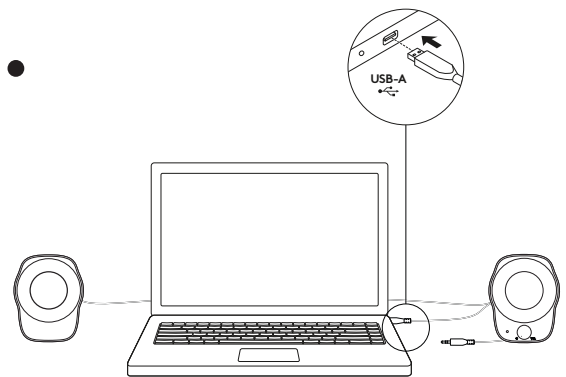

2.

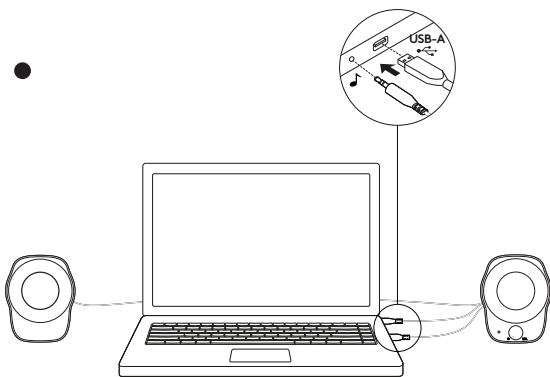

3.

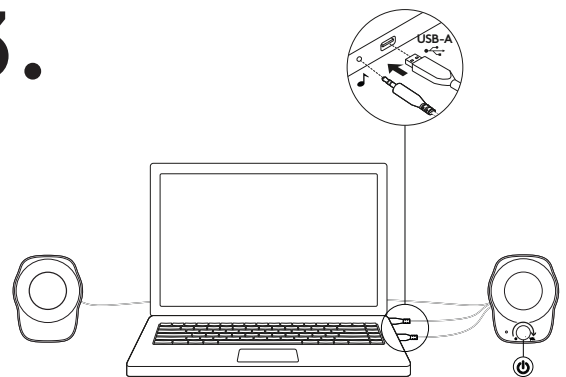

SKAĻUMA REGULĒŠANA

Palieliniet (vai samaziniet) skaļruņu skaļumu, griežot skaļuma regulēšanas pogu uz labā skaļruņa pulksteņrādītāju kustības virzienā (pretēji pulksteņrādītāju kustības virzienam).

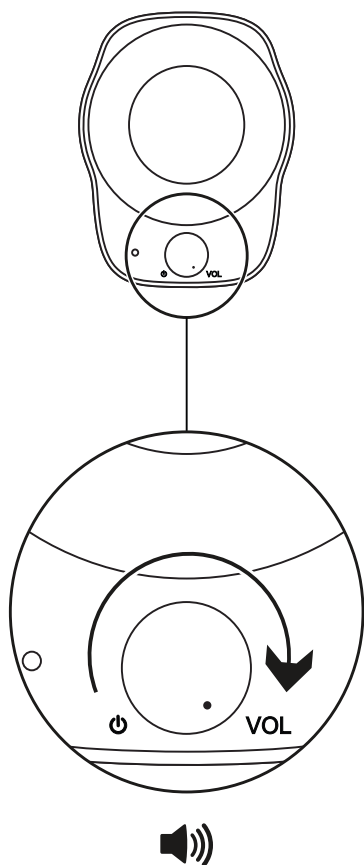

KABEĻA GARUMA REGULĒŠANA

No katra skaļruņa aizmugurē esošajām turētājām varat izritināt papildu vadu garumu.

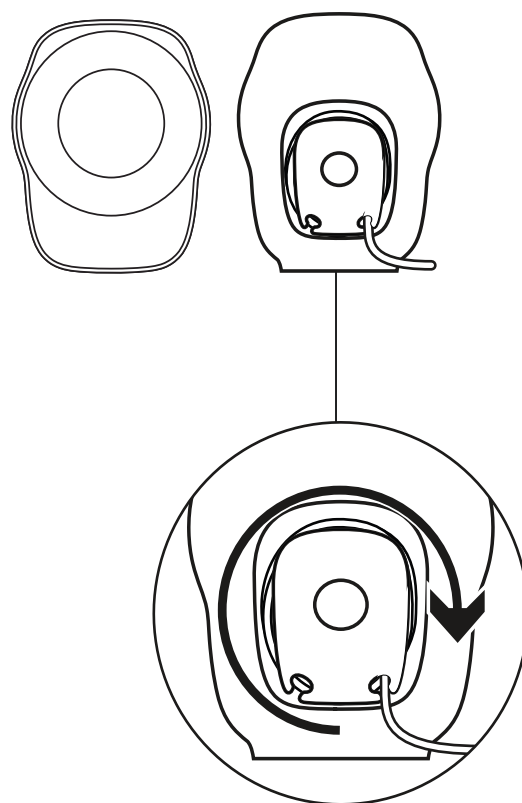

www.logitech.com/support/Z120

SUSIPAŽINKITE SU SAVO PRODUKTU

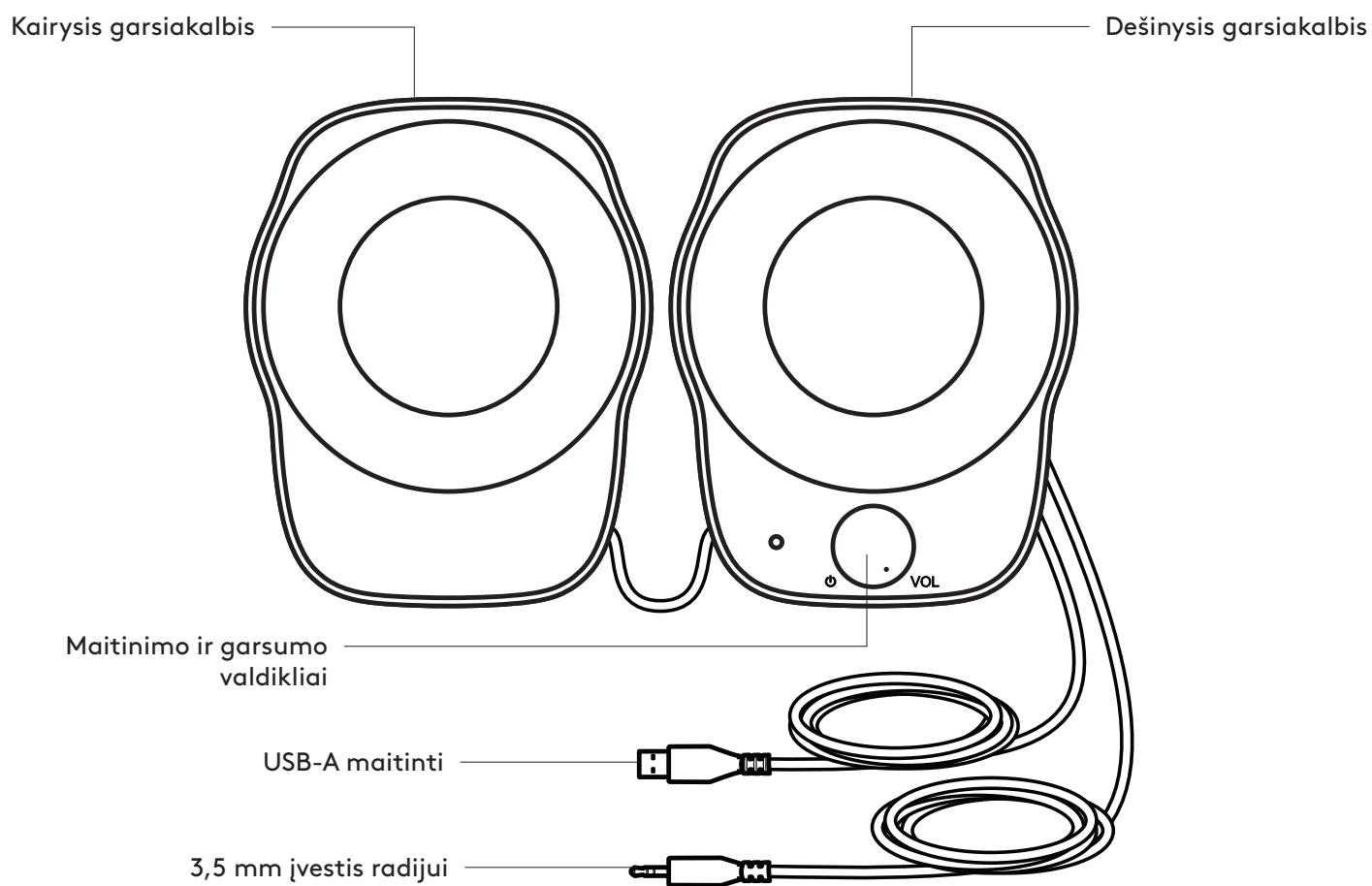
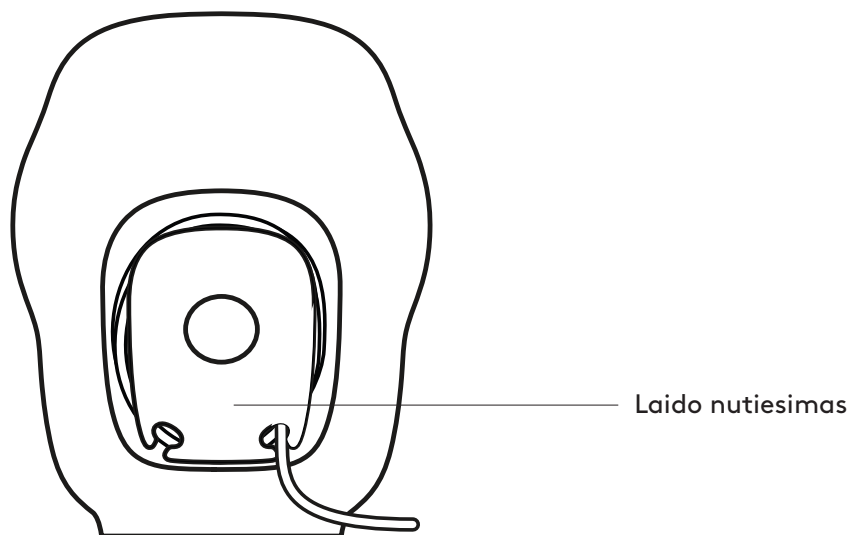

GARSIKALBIŲ PRIJUNGIMAS

1. Norėdami maitinti, prijunkite USB-A kištuką prie USB-A prievado kompiuteryje
2. Prijunkite 3,5 mm jungtį prie 3,5 įvesties garso įrenginyje.
3. Maitinimo rankenėlę įjunkite garsiaikalbį.

1

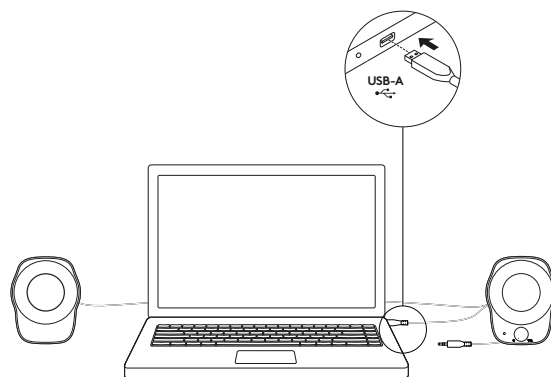

2

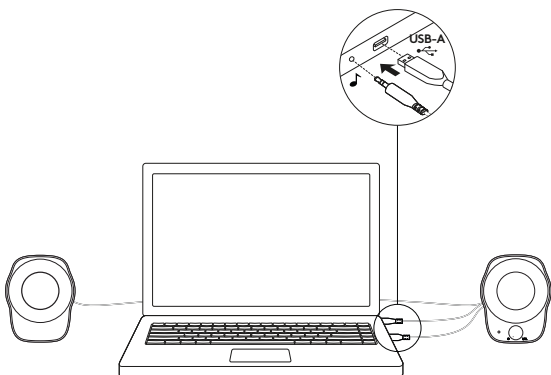

3

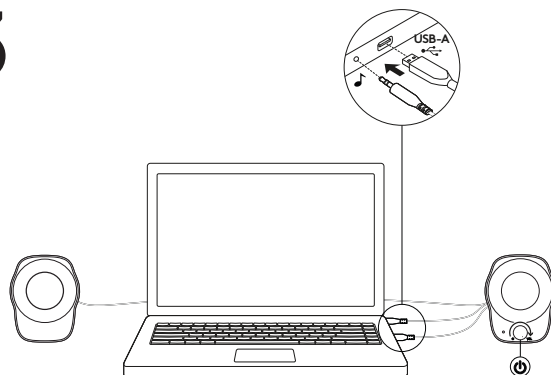

GARSUMO REGULIAVIMAS

Padidinkite (ar sumažinkite) garsiakalbių garsumą pasukdami garsumo reguliavimo rankenėlę pagal laikrodžio rodyklę (arba prieš laikrodžio rodyklę) ant dešiniojo garsiakalbio.

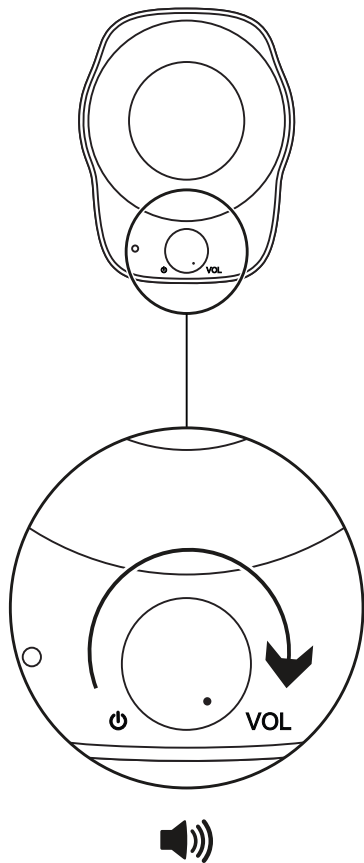

LAIDO NUTIESIMAS

Susikite per ilgą laido dalį į patogias angas už kiekvieno garsiakalbio.

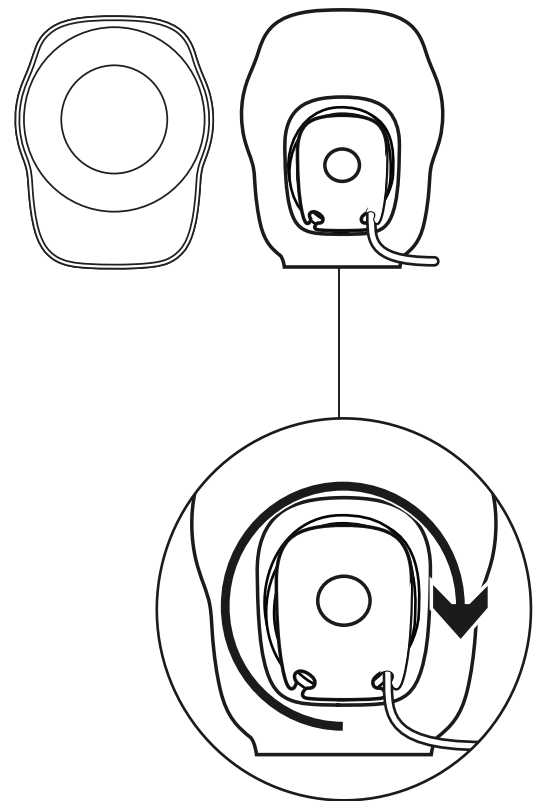

www.logitech.com/support/Z120

ЗАПОЗНАВАНЕ С ПРОДУКТА

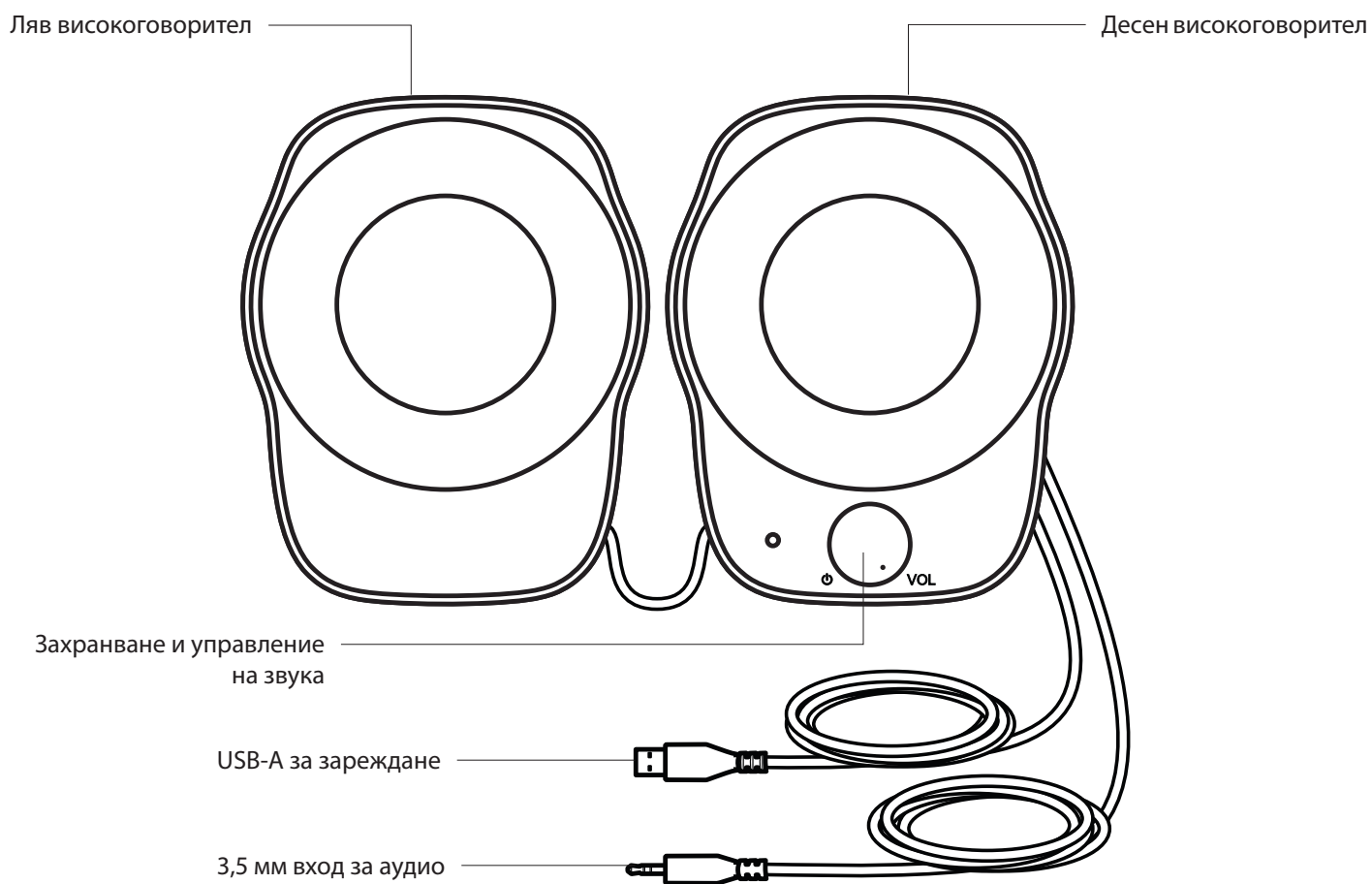
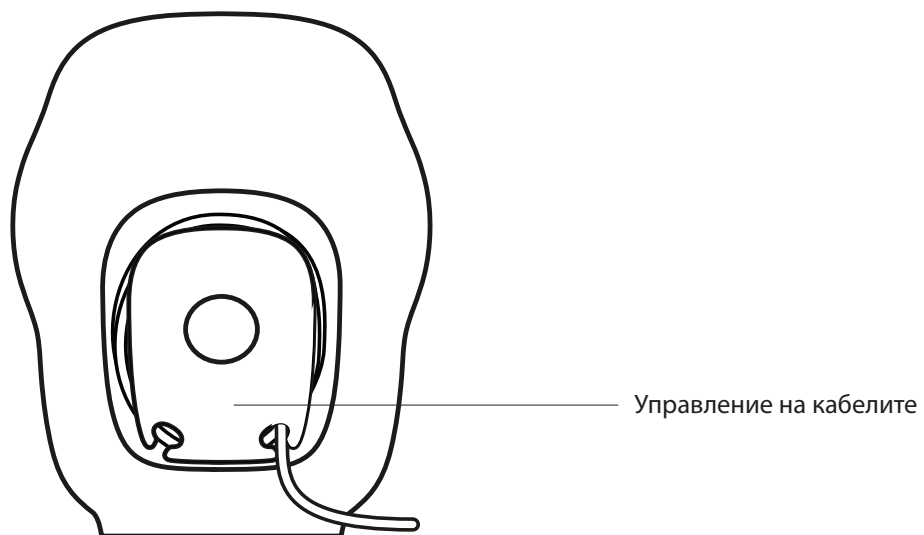

СВЪРЗВАНЕ НА ВИСОКОГОВОРИТЕЛИТЕ

1. Включете USB-A накрайника към USB-A порта за захранване на компютъра.
2. Включете 3,5 мм конектор в 3,5 мм жак на вашето аудиоустройство.
3. Включете високоговорителя, като използвате копчето за захранване.

1

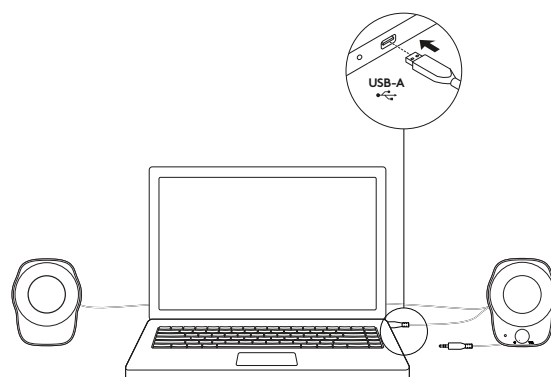

2

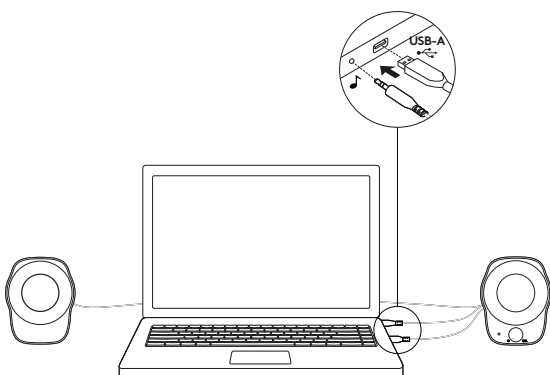

3

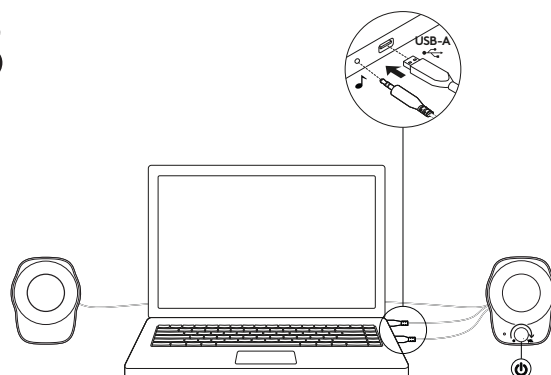

РЕГУЛИРАНЕ НА СИЛАТА НА ЗВУКА

Увеличавайте (или намалявайте) силата на звука на високоговорителите чрез завъртане на копчето за контрол на силата на звука, намиращо се на десния високоговорител, по часовниковата стрелка (срещу часовниковата стрелка).

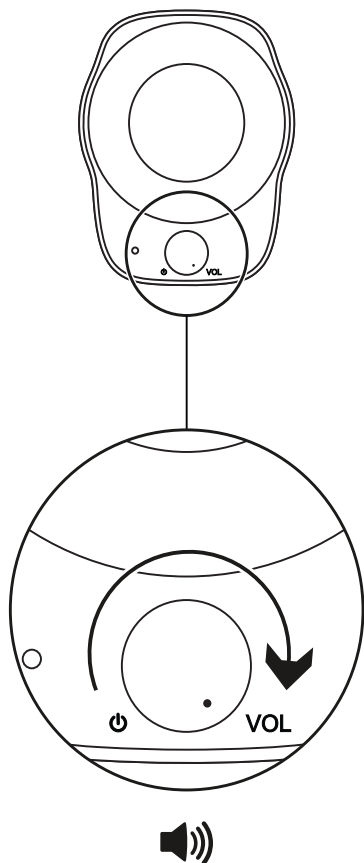

УПРАВЛЕНИЕ НА КАБЕЛИТЕ

Навийте излишната дължина на кабела в удобните отвори зад всеки високоговорител.

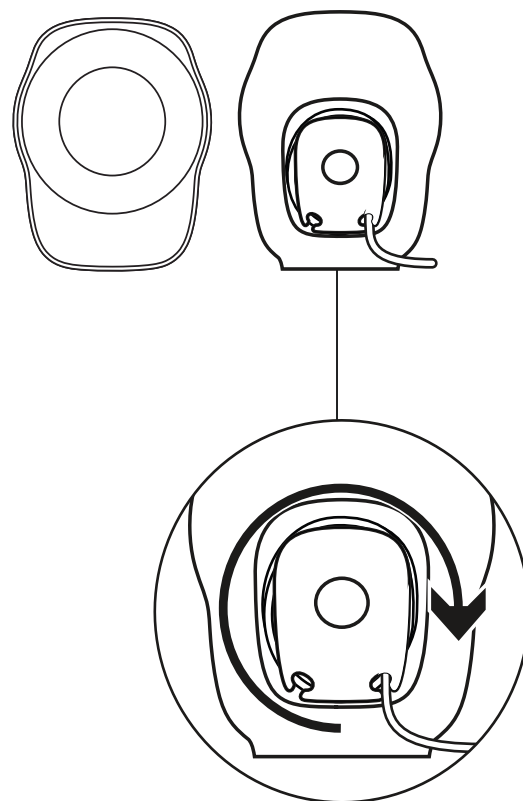

www.logitech.com/support/Z120

UPOZNAJTE SVOJ UREĐAJ

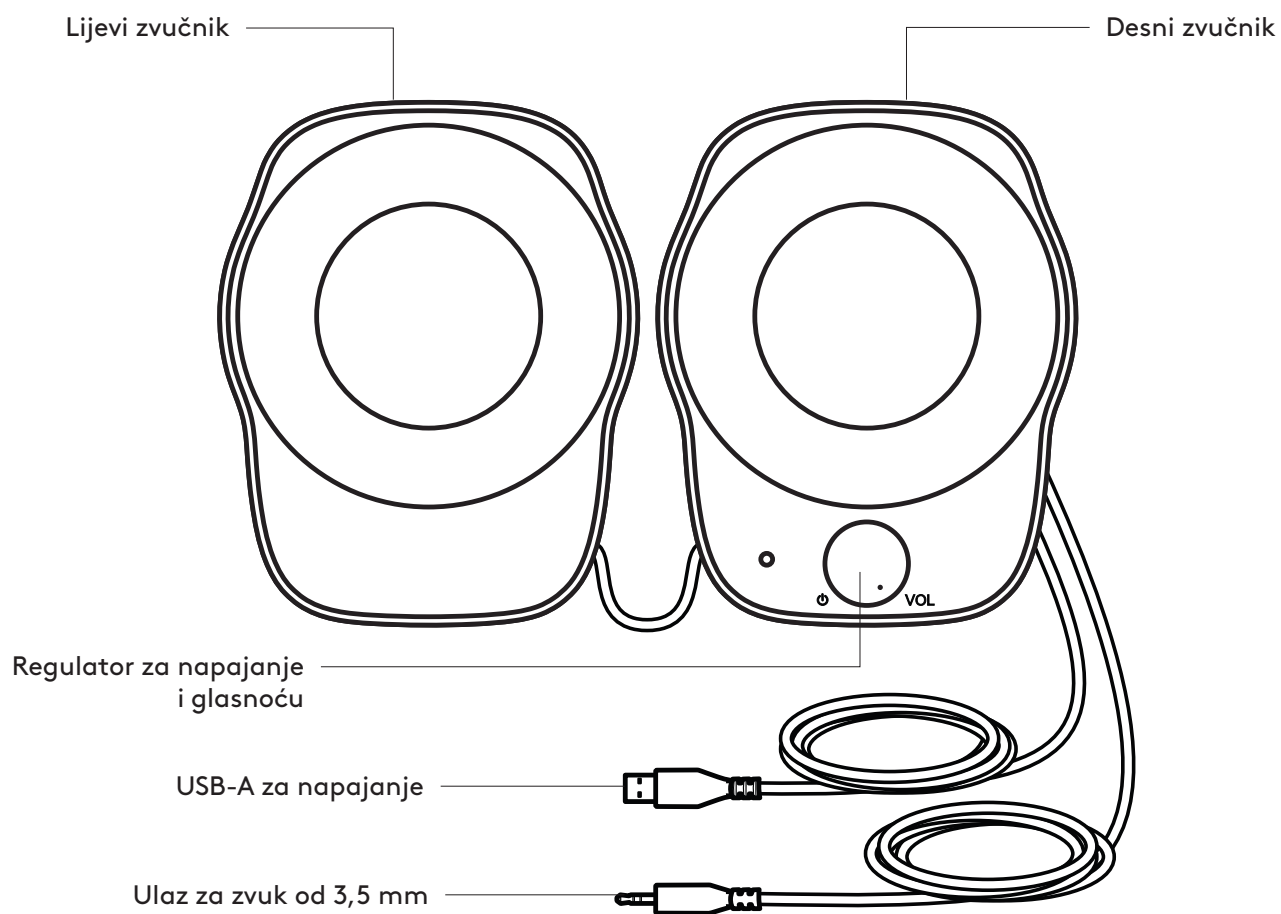
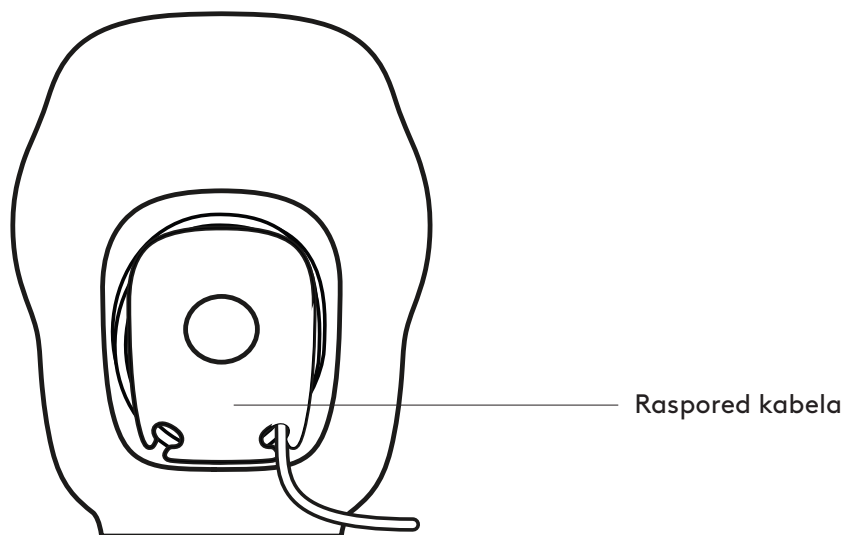

PRIKLJUČIVANJE ZVUČNIKA

1. Za napajanje priključite USB-A priključak u USB-A utor svog računala.
2. Ukopčajte priključak od 3,5mm u utičnicu od 3,5mm na svom audio uređaju.
3. Uključite zvučnik pomoću regulatora za napajanje.

1

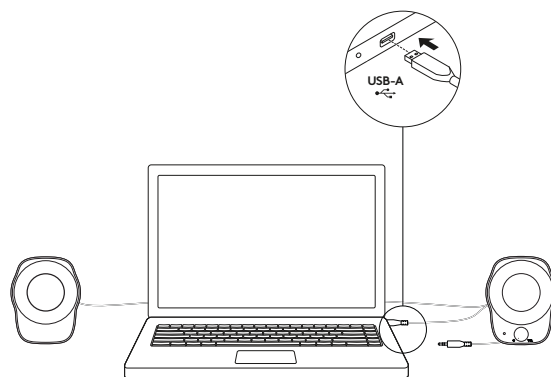

2

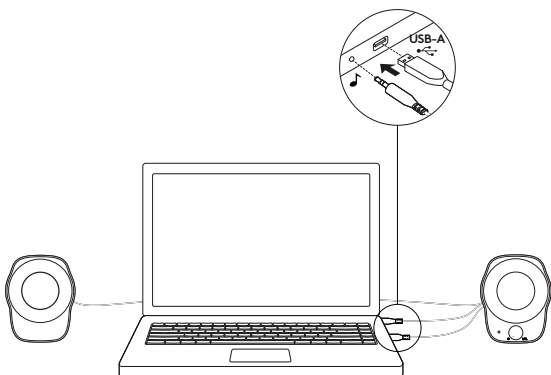

3

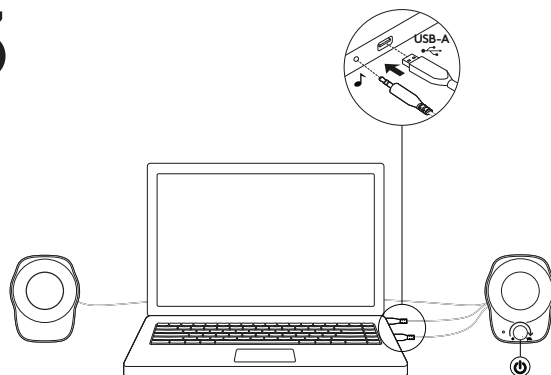

PRILAGODBA GLASNOĆE

Pojačajte (ili stišajte) glasnoću zvučnika okretanjem regulatora za prilagodbu glasnoće u smjeru kazaljke na satu (suprotno od smjera kazaljke na satu) na desnom zvučniku.

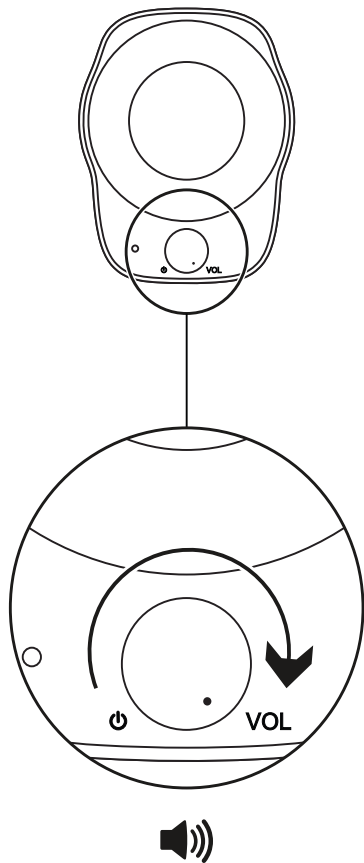

RASPORED KABELA

Namotajte višak kabela u u praktične udubine iza svakog zvučnika.

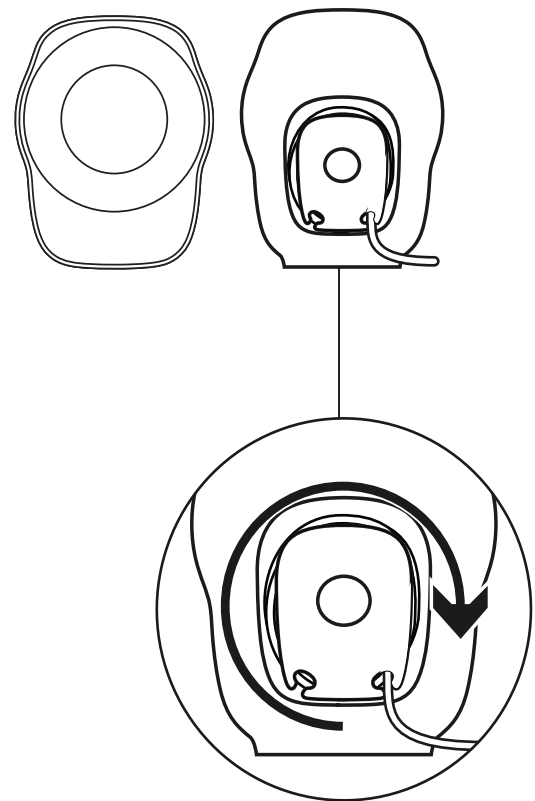

www.logitech.com/support/Z120

UPOZNAJTE OVAJ PROIZVOD

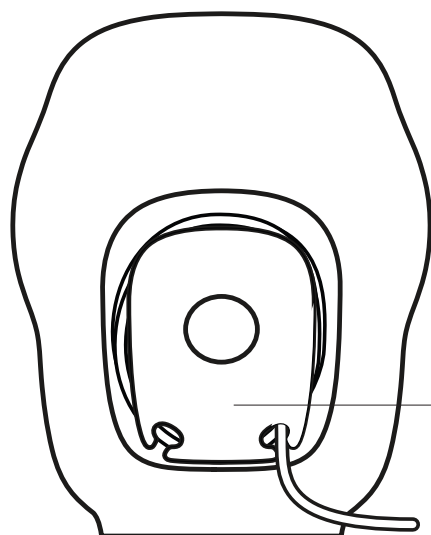

Upravljanje kablovima

Levi zvučnik

Desni zvučnik

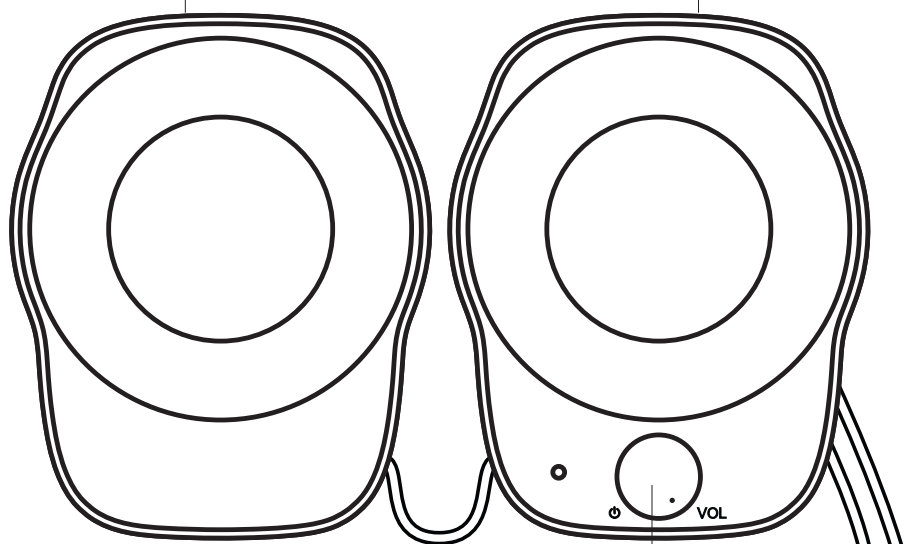

Kontrola napajanja i zvuka

USB-A za napajanje



Ulaz od 3,5 mm za zvuk

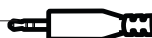

POVEZIVANJE SA ZVUČNICIMA

1. Povežite USB-A kabl sa USB-A portom računara radi napajanja.
2. Povežite konektor od 3,5 mm sa priključkom od 3,5 mm na audio uređaju.
3. Uključite zvučnik korišćenjem dugmeta za napajanje.

1

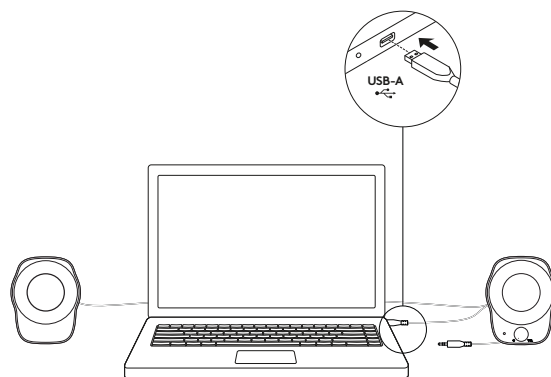

2

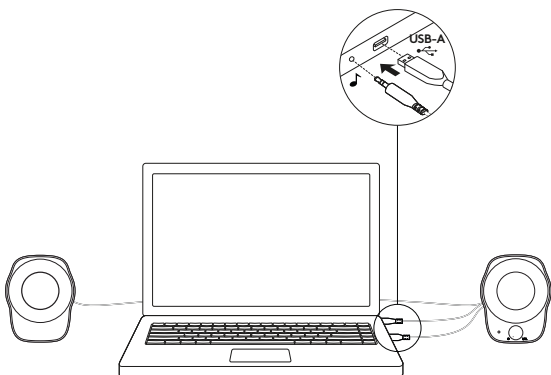

3

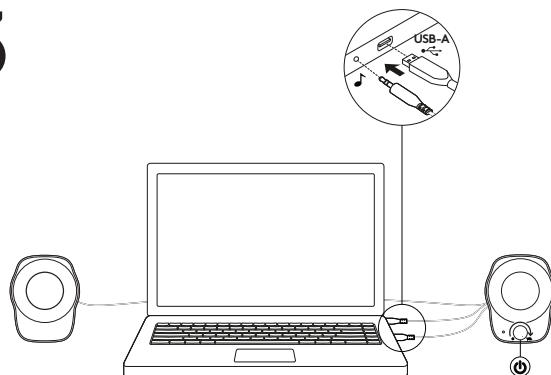

PODEŠAVANJE JAČINE ZVUKA

Povećajte (ili umanjite) jačinu zvuka u zvučnicima rotiranjem dugmeta za kontrolu jačine zvuka u smeru kazaljke na satu (ili obrnuto) na desnom zvučniku.

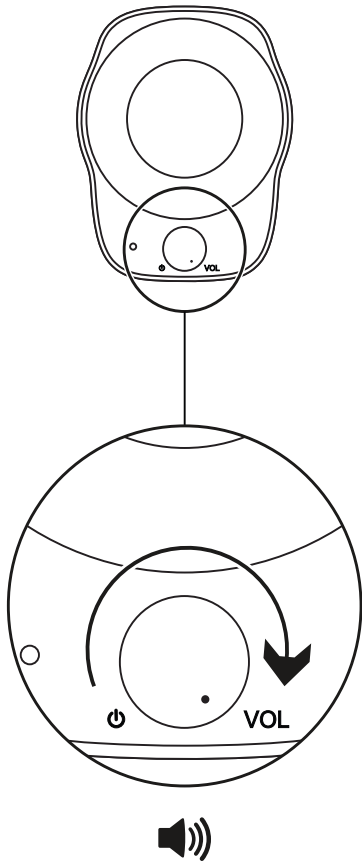

UPRAVLJANJE KABLOVIMA

Namotajte suvišnu dužinu kablova unutar predviđenog otvora iza zvučnika.

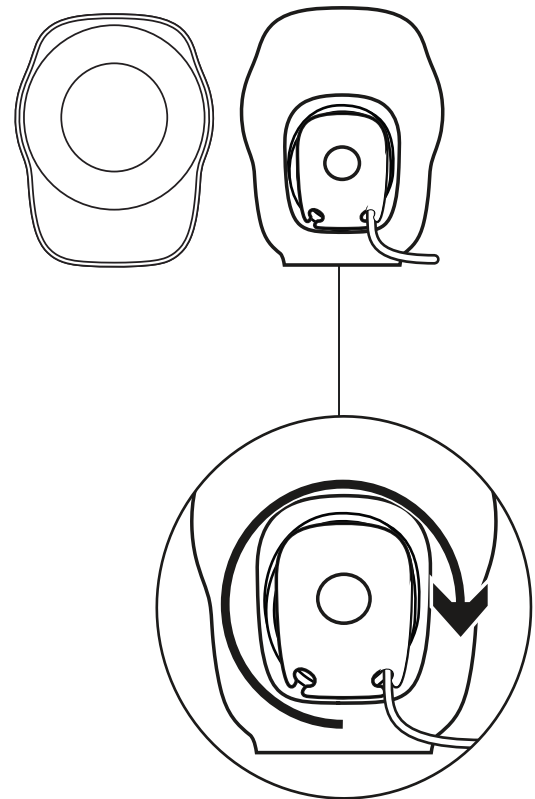

www.logitech.com/support/Z120

SPOZNAJTE IZDELEK

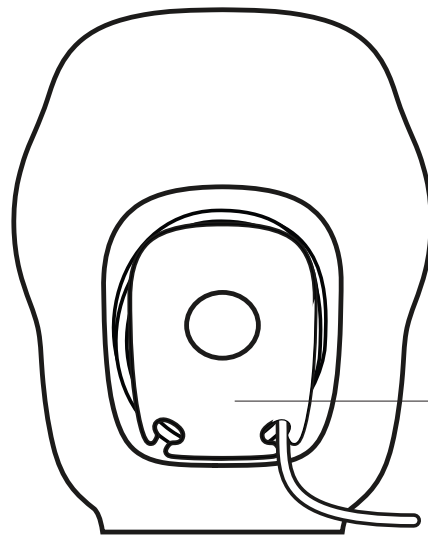

Upravljanje kablov

Levi zvočnik

Desni zvočnik

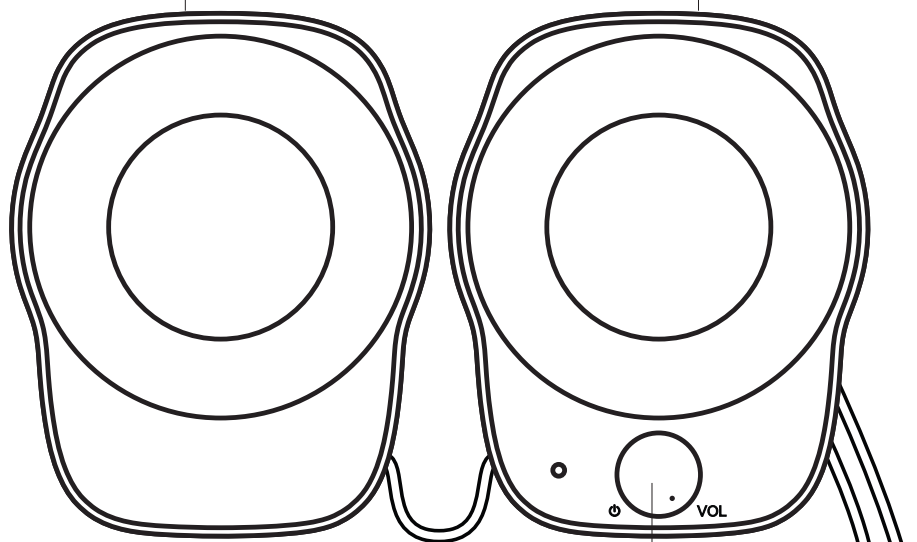

Kontrolnik za napajanje
in nastavitve glasnosti

USB-A za napajanje



3,5-milimetrski vhod za zvok



PRIKLJUČITEV ZVOČNIKOV

1. Vtič USB-A priključite v vrata USB-A na računalniku, da omogočite napajanje.
2. 3,5-milimetrski konektor priključite v 3,5-milimetrski priključek na zvočni napravi.
3. Vklonite zvočnik prek gumba za napajanje.

1

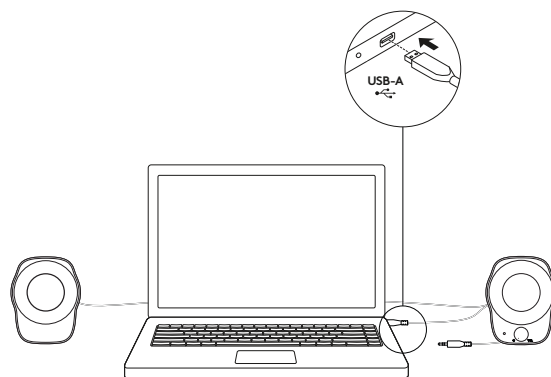

2

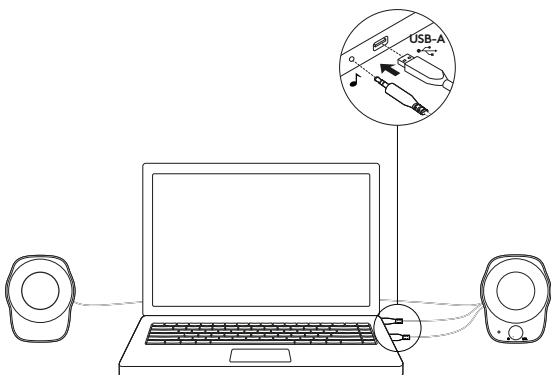

3

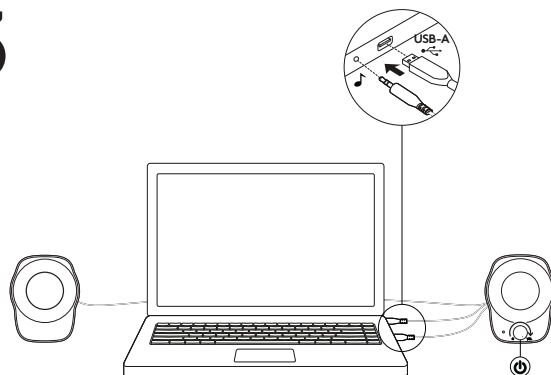

NASTAVITEV GLASNOSTI

Glasnost zvočnikov povečate (oziroma zmanjšate) s sukanjem gumba za nastavitev glasnosti na desnem zvočniku v smeri (oziroma v nasprotni smeri) urnega kazalca.

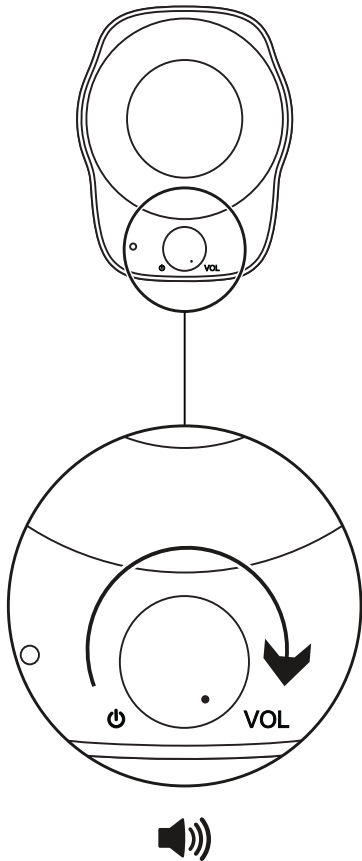

UPRAVLJANJE KABLOV

Odvečni kabel navijite v priročni kanal, ki je na voljo na zadnji strani obeh zvočnikov.

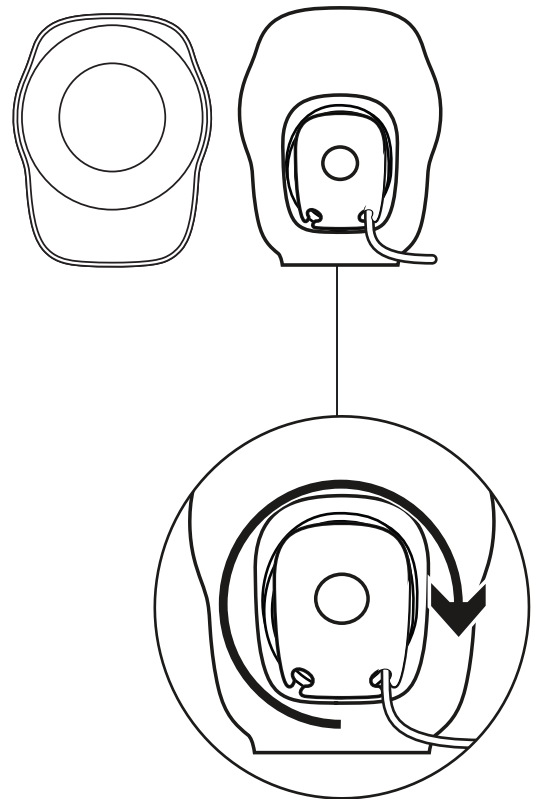

www.logitech.com/support/Z120

FAMILIARIZAȚI-VĂ CU PRODUSUL

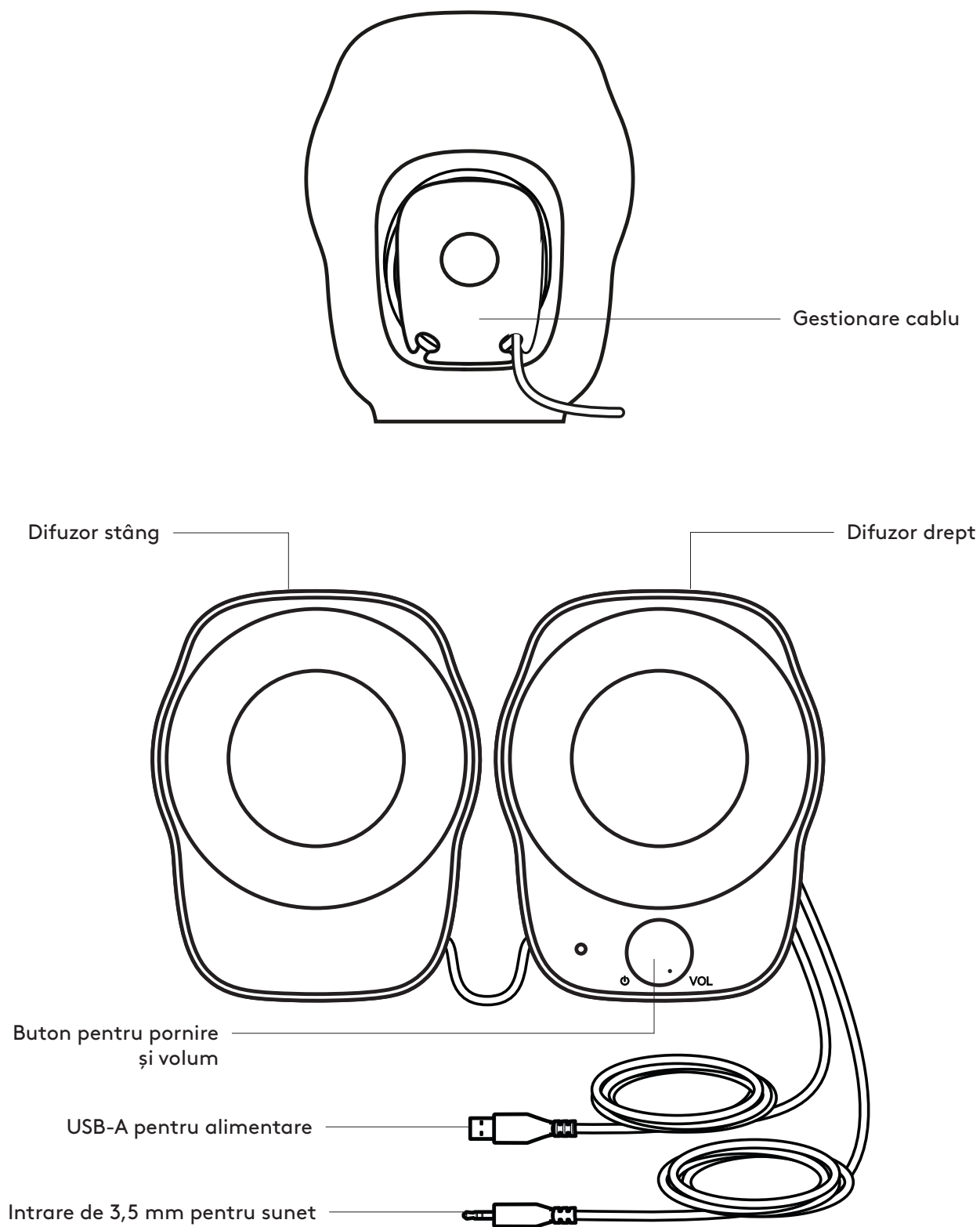

CONECTAREA DIFUZOARELOR

1. Pentru alimentare, introduceți intrarea USB-A în portul USB-A al computerului.
2. Introduceți conectorul de 3,5 mm în mufa de 3,5 mm a dispozitivului audio.
3. Porniți difuzorul utilizând butonul rotativ de pornire.

1

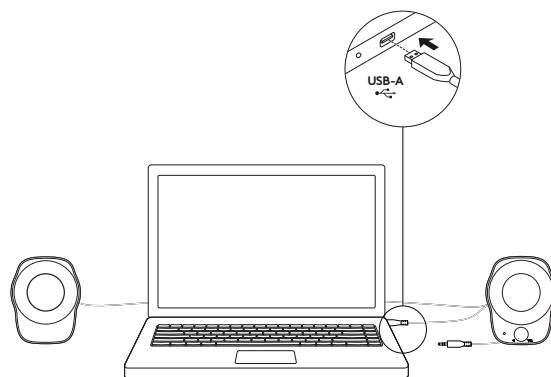

2

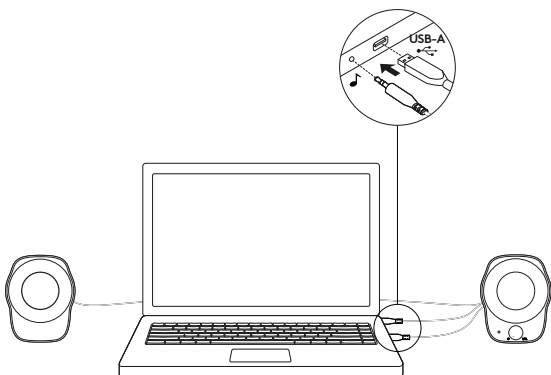

3

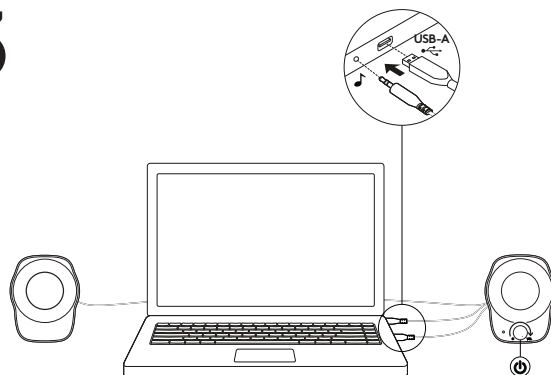

AJUSTAREA VOLUMULUI

Creșteți (sau descreșteți) volumul difuzoarelor răsucind butonul rotativ de pe difuzorul drept în sensul acelor de ceasornic (sau invers).

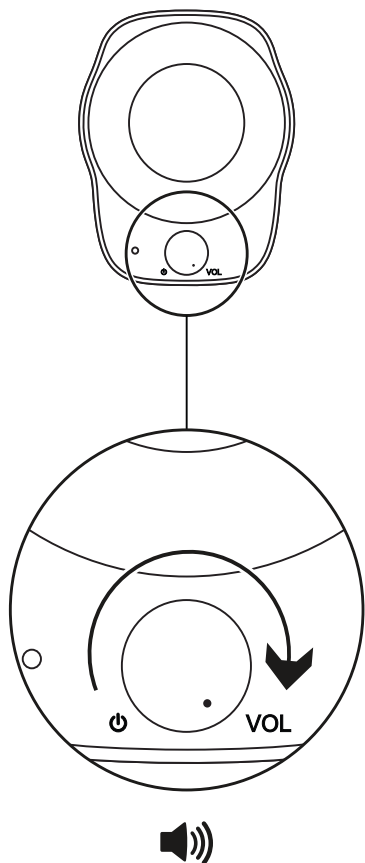

GESTIONAREA CABLURILOR

Înfășurați lungimea suplimentară a cablului în interiorul cavităților convenabile din spatele fiecărui difuzor.

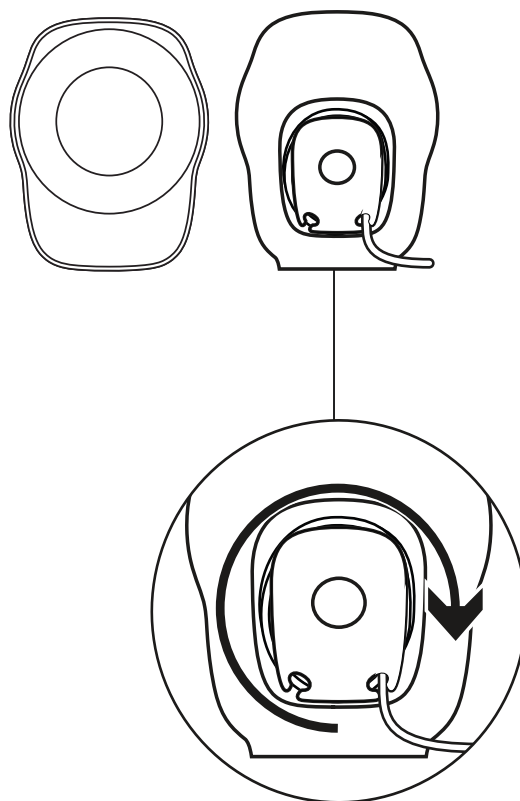

www.logitech.com/support/Z120

ÜRÜNÜNÜZÜ TANIYIN

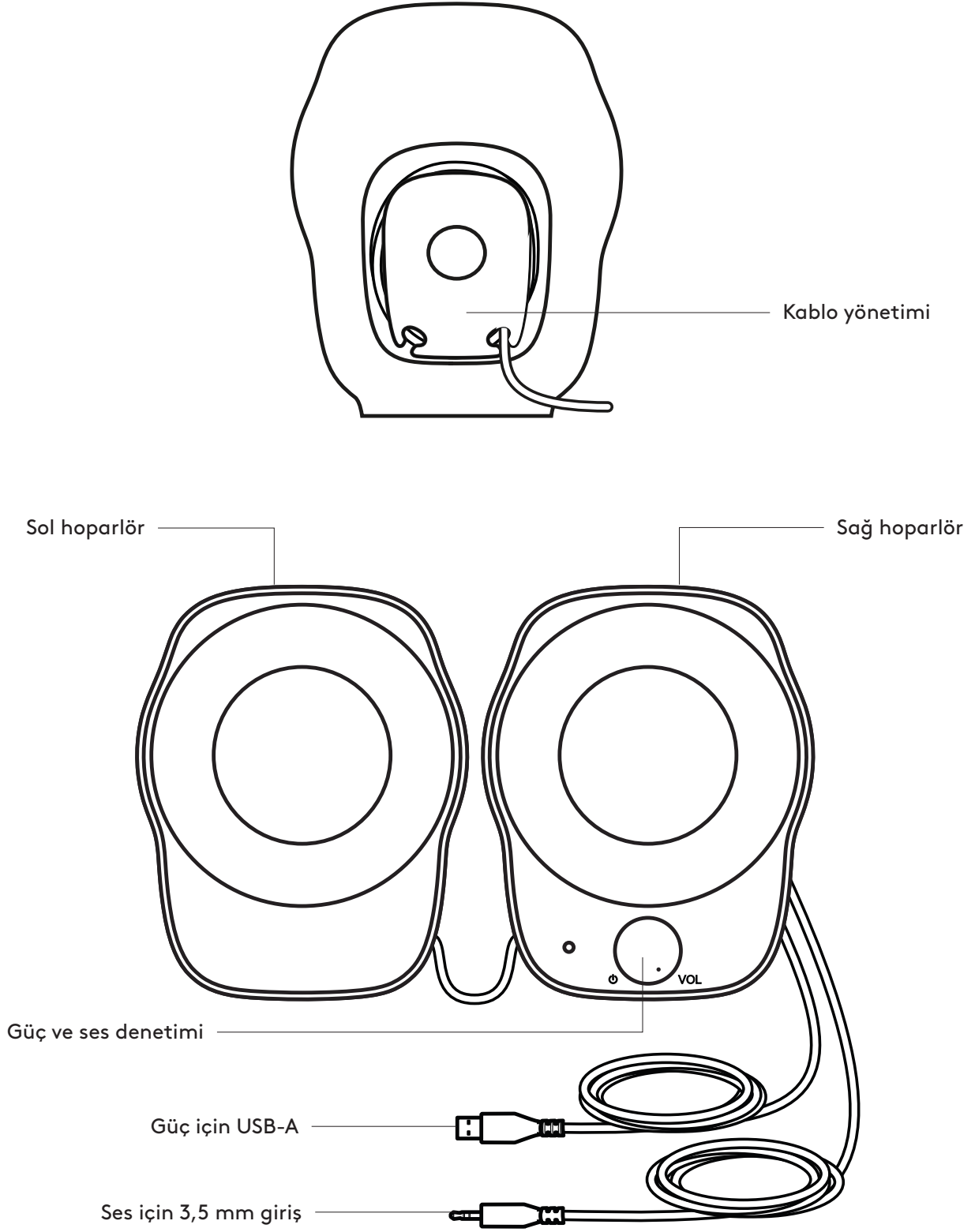

HOPARLÖRLERİ BAĞLAYIN

1. Güç için USB-A kablosunu bilgisayarınızın USB-A bağlantı noktasına takın.
2. 3,5 mm bağlayıcıyı ses aygıtınızın üzerindeki 3,5 mm'lik jake takın.
3. Güç düğmesini kullanarak hoparlörü açın.

1

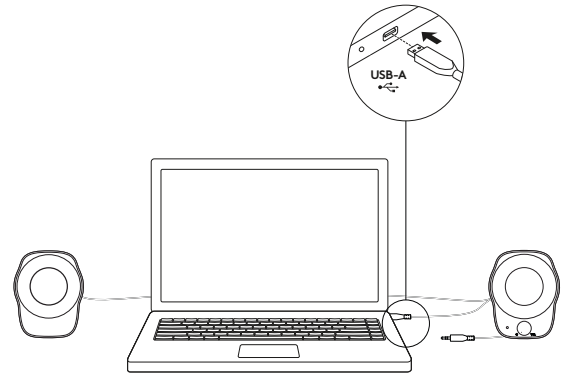

2

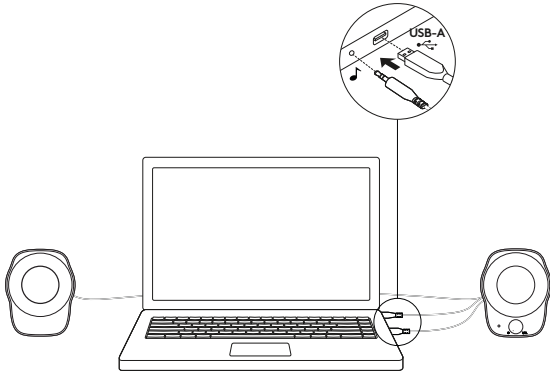

3

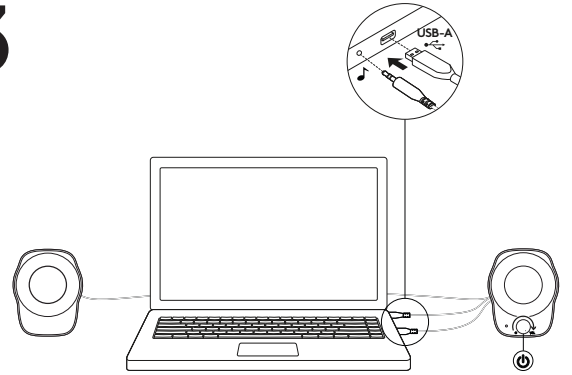

SESİ AYARLAYIN

Sağ hoparlördeki ses kontrol düğmesini saat yönünde (saatin tersi yönünde) döndürerek hoparlörlerin sesini artırın (veya azaltın).

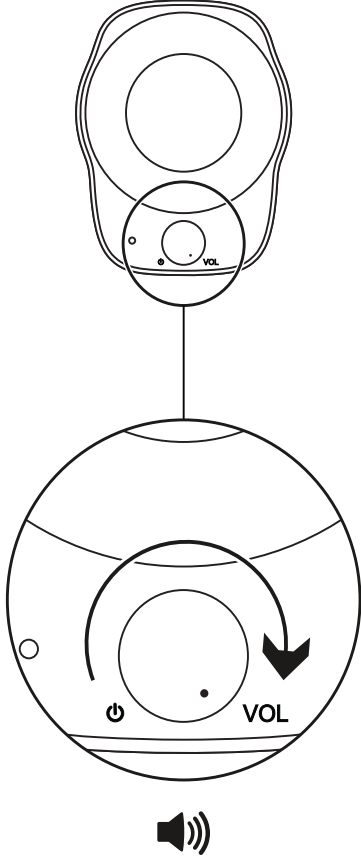

KABLO YÖNETİMİ

Ekstra kabloyu hoparlörlerin arkasındaki uygun yuvalara sarın.

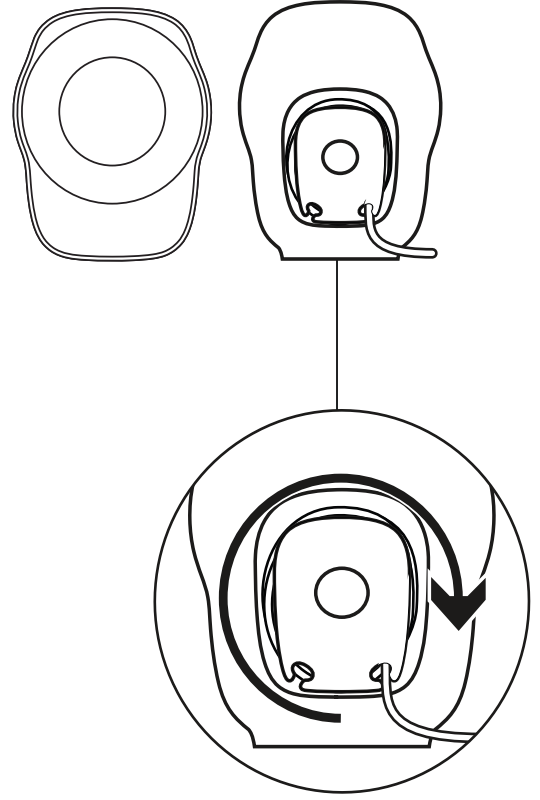

www.logitech.com/support/Z120

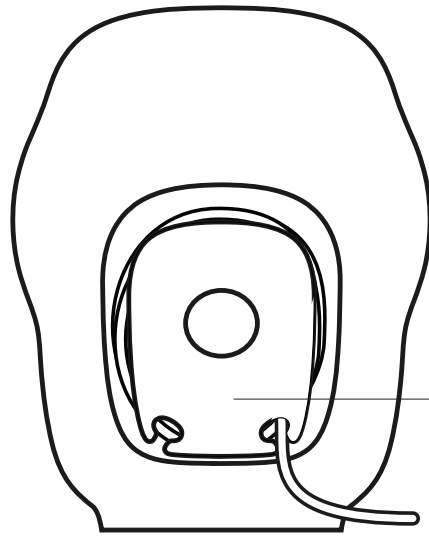

إدارة الكبل

السماعة اليسرى

السماعة اليمنى

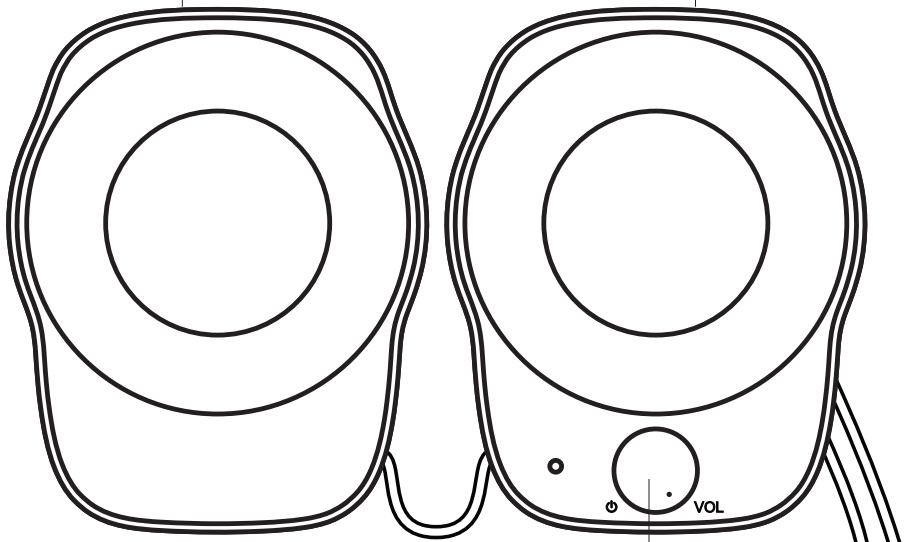

أزرار التحكم بالتشغيل ومستوى الصوت

كبل USB-A للطاقة



مدخل 3.5 ملم للصوت



توصيل السماعات

1. قم بتوصيل كبل USB-A بمنفذ USB-A الموجود في الكمبيوتر للحصول على الطاقة.
2. صِل موصل 3.5 مم في المقبس 3.5 مم في جهاز الصوت الخاص بك.
3. قم بتشغيل السماعة باستخدام مقبض الطاقة.

1

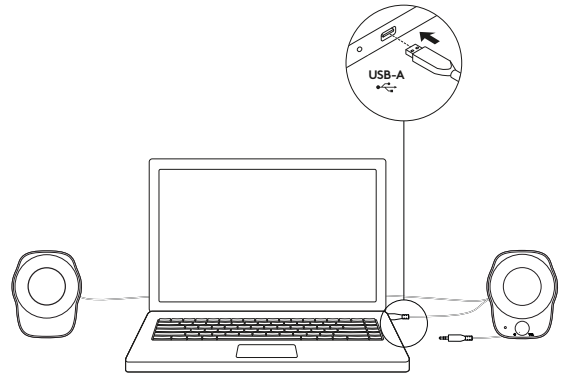

2

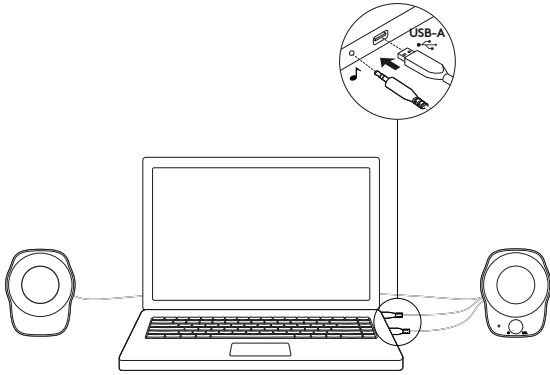

3

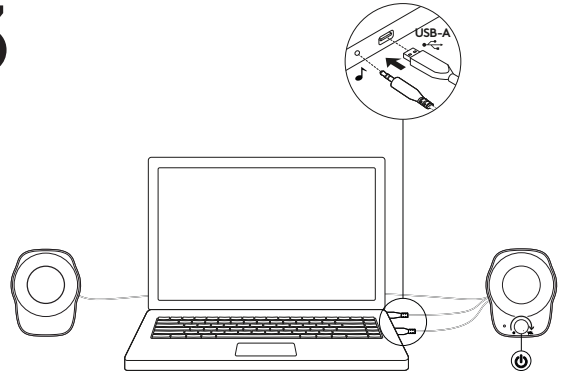

إدارة الكبل

قم بتعبئة طول الكبل الزائد داخل الفتحة المناسبة في الجزء الخلفي من كل سماعة.

ضبط مستوى الصوت

ارفع (أو اخفض) مستوى صوت السماعات من خلال تدوير مقبض التحكم بمستوى الصوت باتجاه عقارب الساعة (أو بعكس اتجاه عقارب الساعة) بالسماعة اليمنى.

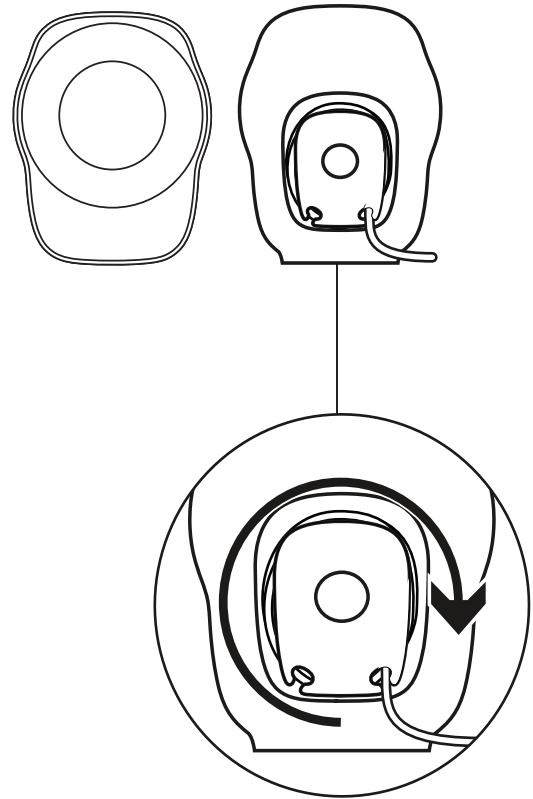
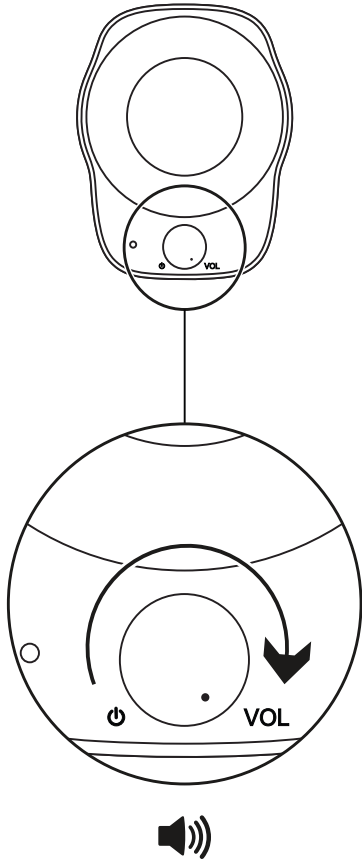

www.logitech.com/support/Z120

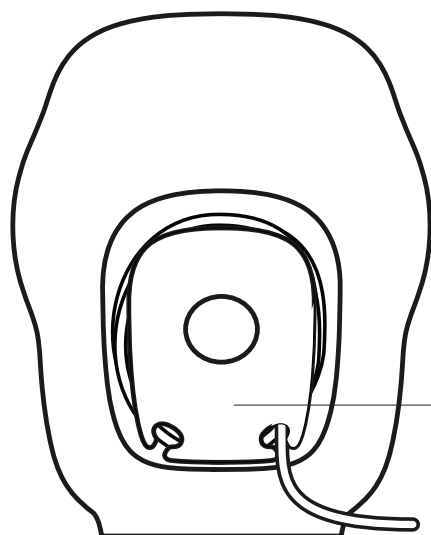

ניהול כבלים

רמקול שמאל

רמקול ימין

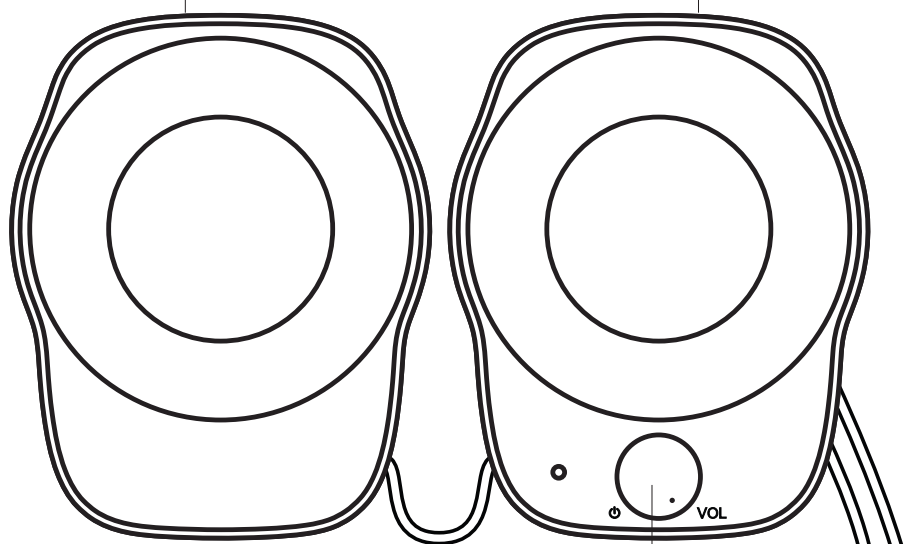

חשמל ובקרת עוצמת קול

USB-A עבור חשמל



כניסת 3.5 מ"מ עבור שמע



חבר את הרמקולים

1. לחיבור חשמל, חבר את שקע USB-A אל יציאת USB-A במחשב שלך.
2. חבר את מחבר 3.5 מ"מ לשקע 3.5 מ"מ במכשיר השמע.
3. הפעל את הרמקול באמצעות ידית החשמל.

1

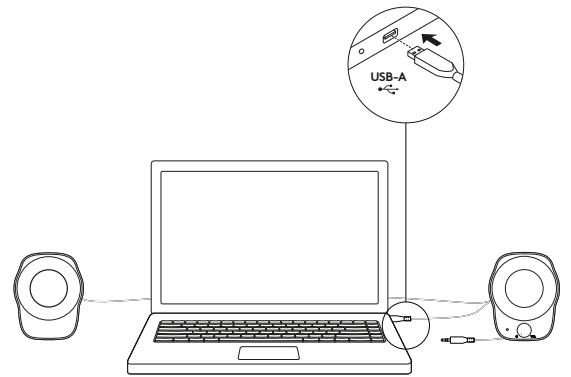

2

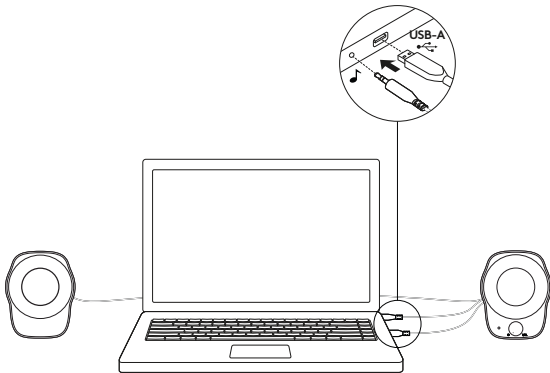

3

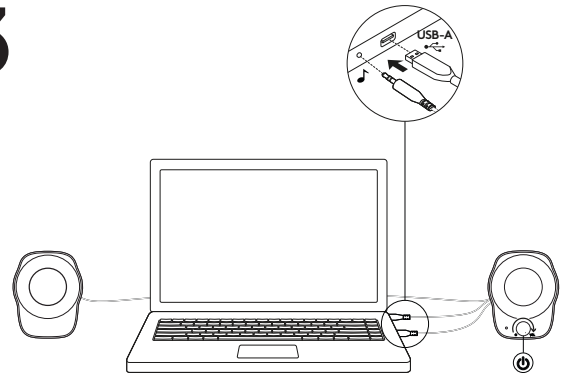

ניהול כבלים

מתח אורך כבל נוסף הנמצאים בתוך מעגן הכבלים מאחורי כל רמקול.

כיוון את עוצמת הקול

הגבר (או הנמך) את עוצמת קול הרמקולים על ידי סיבוב ידית שליטה על עוצמת הקול בכיוון השעון (נגד כיוון השעון) ברמקול הימני.

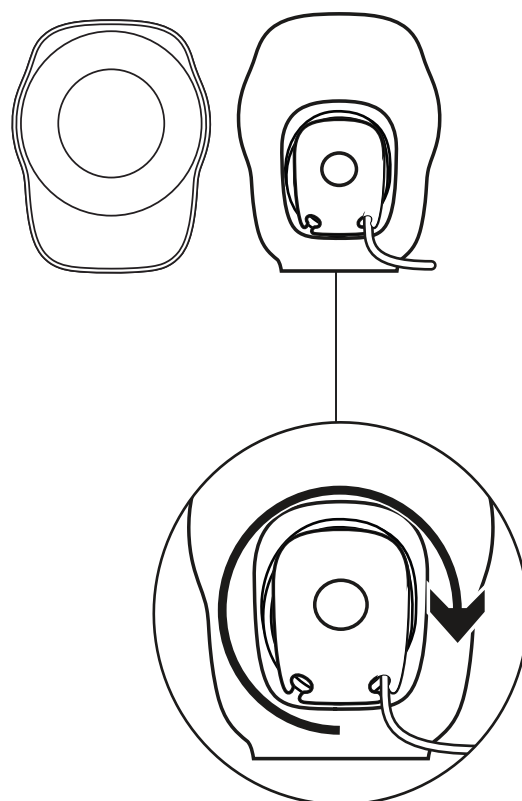
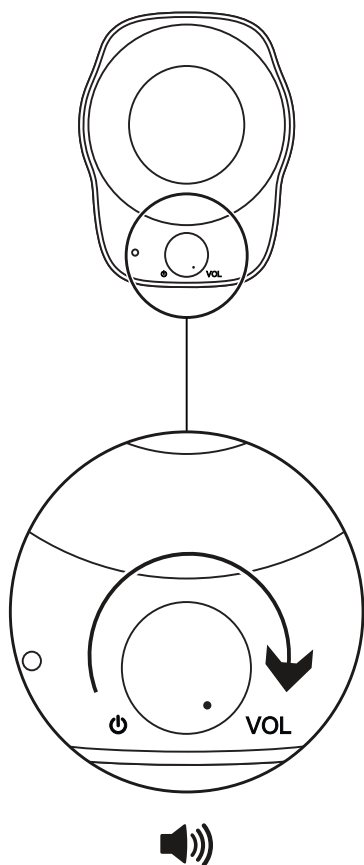

www.logitech.com/support/Z120

www.logitech.com/support/Z120

© 2019 Logitech. Logitech, Logi and other Logitech marks are owned by Logitech and may be registered. All other trademarks are the property of their respective owners. Logitech assumes no responsibility for any errors that may appear in this manual. Information contained herein is subject to change without notice.

WEB-621-001290.002

logitech®